

---

United States  
Department of  
Agriculture

Natural  
Resources  
Conservation  
Service

---

**Part 651**  
**Agricultural Waste Management**  
**Field Handbook**

---

**Chapter 10**

---

**Agricultural Waste**  
**Management System**  
**Component Design**

Issued August 2009

The U.S. Department of Agriculture (USDA) prohibits discrimination in all its programs and activities on the basis of race, color, national origin, age, disability, and where applicable, sex, marital status, familial status, parental status, religion, sexual orientation, genetic information, political beliefs, reprisal, or because all or a part of an individual's income is derived from any public assistance program. (Not all prohibited bases apply to all programs.) Persons with disabilities who require alternative means for communication of program information (Braille, large print, audiotape, etc.) should contact USDA's TARGET Center at (202) 720-2600 (voice and TDD). To file a complaint of discrimination, write to USDA, Director, Office of Civil Rights, 1400 Independence Avenue, SW., Washington, DC 20250-9410, or call (800) 795-3272 (voice) or (202) 720-6382 (TDD). USDA is an equal opportunity provider and employer.

---

# Acknowledgments

---

Chapter 10 was originally prepared and reprinted with minor revisions in 1996 under the direction of by **James N. Krider** (retired), national environmental engineer, Soil Conservation Service (SCS), now Natural Resources Conservation Service (NRCS). **James D. Rickman** (retired), environmental engineer, NRCS, Fort Worth, TX, provided day-to-day coordination in the development of the handbook. Authors for chapter 10 included **L.M. “Mac” Safley**, North Carolina State University, Raleigh, NC; **Carl DuPoldt** (retired), water quality specialist, NRCS, Chester, PA; **Frank Geter** (retired) environmental engineer, NRCS, Chester, PA; **Donald Stettler** (retired), environmental engineer, NRCS, Portland, OR; and **Timothy Murphy** (retired), assistant State conservation engineer, NRCS, Harrisburg, PA.

This version was prepared under the direction of **Noller Herbert**, Director, Conservation Engineering Division, NRCS, Washington, DC. Revisions to the chapter were provided by **Darren Hickman**, environmental engineer, Central National Technology Support Center, NRCS, Fort Worth, TX; **Charles Zuller**, environmental engineer, West National Technology Support Center, NRCS, Portland, OR; **Bill Reck**, environmental engineer, East National Technology Support Center, NRCS, Greensboro, NC; **Cherie LaFleur**, environmental engineer, Central National Technology Support Center, NRCS, Fort Worth, TX; and **Peter Vanderstappen**, agricultural engineer, NRCS, Lebanon, PA. It was finalized under the guidance of **Darren Hickman**, national environmental engineer, NRCS, Conservation Engineering Division, Washington, DC.





---

<b>Contents</b>	<b>651.1000 Introduction</b>	<b>10-1</b>
	(a) Planning considerations .....	10-1
	(b) Selected alternative.....	10-1
	(c) Design, installation, and operation .....	10-1
	<b>651.1001 Production</b>	<b>10-2</b>
	(a) Roof runoff management .....	10-2
	(b) Runoff control.....	10-5
	(c) Air quality considerations .....	10-5
	<b>651.1002 Collection</b>	<b>10-6</b>
	(a) Alleys.....	10-6
	(b) Gutters .....	10-9
	(c) Slatted floors.....	10-10
	<b>651.1003 Transfer</b>	<b>10-13</b>
	(a) Reception pits .....	10-13
	(b) Gravity flow pipes .....	10-14
	(c) Push-off ramps.....	10-14
	(d) Pumps .....	10-14
	(e) Equipment .....	10-16
	<b>651.1004 Storage</b>	<b>10-17</b>
	(a) Manure storage facilities for solids.....	10-17
	(b) Liquid and slurry manure storage .....	10-23
	<b>651.1005 Treatment</b>	<b>10-34</b>
	(a) Primary treatment .....	10-34
	(b) Secondary treatment.....	10-38
	<b>651.1006 Utilization</b>	<b>10-73</b>
	(a) Nutrient management .....	10-73
	(b) Land application equipment.....	10-73
	(c) Land application of municipal sludge.....	10-74
	(d) Bioenergy production .....	10-74
	<b>651.1007 Mortality management</b>	<b>10-81</b>
	(a) Rendering and freezing.....	10-81
	(b) Incineration.....	10-81
	(c) Gasification .....	10-81
	(d) Sanitary landfill.....	10-81
	(e) Burial.....	10-81
	(f) Composting .....	10-81
	(h) Emergency mortality management .....	10-87

<b>651.1008</b>	<b>Safety</b>	<b>10–88</b>
	(a) Confined areas .....	10–88
	(b) Aboveground tanks .....	10–89
	(c) Lagoons, ponds, and liquid storage structures .....	10–89
	(d) Equipment .....	10–89
	(e) Fences .....	10–89

<b>651.1009</b>	<b>References</b>	<b>10–90</b>
-----------------	-------------------	--------------

**Appendices**

<b>Appendix A</b>	Blank Worksheets
<b>Appendix B</b>	Rainfall Intensity Maps
<b>Appendix C</b>	Runoff from Feedlots and Evaporation
<b>Appendix D</b>	Design and Construction Guidelines for Waste Impoundments Lined with Clay or Amendment-treated Soil
<b>Appendix E</b>	Synthetic Liners Guidelines

**Tables**

<b>Table 10–1</b>	Recommended total daily flush volumes	10–7
<b>Table 10–2</b>	Flush tank volumes and discharge rates	10–7
<b>Table 10–3</b>	Minimum slope for flush alleys	10–7
<b>Table 10–4</b>	Criteria for siting, investigation, and design of liquid manure storage facilities	10–25
<b>Table 10–5</b>	Operational data for solid/liquid separators (a); settling basin performance (b)	10–36
<b>Table 10–6</b>	Characteristics of solid/liquid separators	10–37
<b>Table 10–7</b>	Sludge accumulation ratios	10–41
<b>Table 10–8</b>	Typical carbon to nitrogen ratios of common composting amendments	10–59
<b>Table 10–9</b>	Volume factor if nitrogen source, such as poultry litter, is used	10–82
<b>Table 10–10</b>	Animal mortality rates	10–84
<b>Table 10–11</b>	Broiler compost mix	10–85

**Figures**

<b>Figure 10–1</b>	Roof gutter and downspout	10–2
<b>Figure 10–2</b>	Diversion of clean water around feedlot	10–5
<b>Figure 10–3</b>	Scrap alley used in dairy barns	10–6
<b>Figure 10–4</b>	Dairy flush alley	10–7
<b>Figure 10–5</b>	Swine flush alley	10–7
<b>Figure 10–6</b>	Flush tanks	10–8
<b>Figure 10–7</b>	Flush and gravity flow gutters for swine manure	10–9
<b>Figure 10–8</b>	Gravity gutter for dairy manure	10–10
<b>Figure 10–9</b>	Shuttle-stroke gutter cleaner	10–11
<b>Figure 10–10</b>	Chain and flight gutter cleaner	10–11
<b>Figure 10–11</b>	Concrete gang slats	10–12
<b>Figure 10–12</b>	Reception pit for dairy freestall barn	10–13
<b>Figure 10–13</b>	Examples of gravity flow transfer	10–15
<b>Figure 10–14</b>	Push-off ramp	10–16
<b>Figure 10–15</b>	Solid manure stacking facilities	10–18
<b>Figure 10–16</b>	Roofed solid manure storage	10–19
<b>Figure 10–17</b>	Solid manure storage with picket dam	10–22
<b>Figure 10–18</b>	Cross section of waste storage pond without a watershed	10–23
<b>Figure 10–19</b>	Cross section of waste storage pond with watershed	10–24
<b>Figure 10–20</b>	Waste storage ponds	10–24
<b>Figure 10–21</b>	Layout of waste storage ponds	10–26
<b>Figure 10–22</b>	Aboveground waste storage tank	10–27
<b>Figure 10–23</b>	Belowground waste storage structure	10–27
<b>Figure 10–24</b>	Schematic of mechanical solid-liquid separators	10–35
<b>Figure 10–25</b>	Design aid to determine quantity of water to add to achieve a desired TS concentration	10–38

<b>Figure 10–26</b>	Anaerobic lagoon cross section	10–39
<b>Figure 10–27</b>	Anaerobic lagoon loading rate (lb VS/1,000 ft <sup>3</sup> /d) (29)	10–40
<b>Figure 10–28</b>	Anaerobic lagoon recycle systems	10–42
<b>Figure 10–29</b>	Aerobic lagoon cross section	10–46
<b>Figure 10–30</b>	Aerobic lagoon loading rate (lb BOD <sub>5</sub> /acre/d) (29)	10–47
<b>Figure 10–31</b>	Relation of dissolved oxygen saturation to water temperature (clean water at 20 °C and sea level)	10–52
<b>Figure 10–32</b>	Relation of dissolved oxygen saturation to elevation above mean sea level	10–52
<b>Figure 10–33</b>	Numerical values for $O_t^{t-20}$ at different temperatures where $O=1.024$	10–52
<b>Figure 10–34</b>	Schematic of an oxidation ditch	10–53
<b>Figure 10–35</b>	Windrow schematic	10–54
<b>Figure 10–36</b>	Static pile composting schematic	10–55
<b>Figure 10–37</b>	In-vessel composting schematic	10–56
<b>Figure 10–38</b>	Compost mixture design flowchart	10–61
<b>Figure 10–39</b>	Composting temperature	10–69
<b>Figure 10–40</b>	Typical temperature rhythm of windrow method	10–69
<b>Figure 10–41</b>	Agricultural composting process flow	10–70
<b>Figure 10–42</b>	Two-stage, mixed tank anaerobic digester	10–75
<b>Figure 10–43</b>	Typical anaerobic digester types	10–76
<b>Figure 10–44</b>	Gas agitation in an anaerobic digester	10–76
<b>Figure 10–45</b>	Dead animal composting bin	10–83
<b>Figure 10–46</b>	Recommended layering for dead bird composting	10–85

### 651.1000 Introduction

Ideally, the by-products of agricultural operations would be immediately returned to the soil from where they were generated. Unfortunately, this is usually not possible or economically justifiable. By-products of animal operations such as manure are biologically and chemically active, often requiring intermediate steps before final utilization. In addition, land application of manure is labor intensive and may be difficult or prohibited while the ground is frozen, crops are at certain growth stages, or when the ground is saturated. Temporary storage may reduce the potential for water pollution by allowing final utilization to occur at optimal times and by preventing runoff from entering ground water or surface water. However, the nutrient content of manure degrades over time, requiring a balance between convenience and the economics of nutrient utilization. Design considerations must include location, installation, and operation and maintenance.

Possible alternatives for manure management are available for any given agricultural operation. A manure management system may consist of any one or all of the following functions: production, collection, storage, treatment, transfer, and utilization. These functions are carried out by planning, applying, and operating individual components.

#### (a) Planning considerations

A successful manure management system must address production, operation, regulatory guidelines, and environmental considerations. The needs of the owner and/or decisionmaker are also vital considerations. The National Planning Procedures Handbook (NPPH) describes the nine-step process for planning.

##### (1) Landowner/decisionmaker desires

Input from the owner, operator, and/or decisionmaker is critical for success of any planned operation. Managerial ability and long-range plans, in addition to current resources, must be considered. Also, financial considerations may determine the selected alternative.

##### (2) Regulatory requirements

Local, State, and Federal regulations must be considered at all stages. Environmental laws and specific

State and Federal program requirements may impact current or potential activities and alternatives.

##### (3) Existing structure assessment and evaluation

Inventorying existing equipment and structures is an important part of planning. Using available resources may reduce the cost of system installation, but constrain the possible alternatives considered. An evaluation of the best alternative should consider both short- and long-term costs of operation and maintenance.

##### (4) Vulnerability and risk

Operating a livestock facility creates an environmental risk for pollution. Climatic conditions and operating procedures can lead to an accidental discharge into surface waters. Foundation problems can result in seepage into subsurface waters. Location of a facility is an extremely important consideration during the planning process to minimize exposure to vulnerability and risk.

#### (b) Selected alternative

Alternatives may consist of components like a piece of equipment, such as a pump; a structure, such as a waste storage tank; or an operation, such as composting. A system should consist of the best combination of the components that allows the flexibility needed to efficiently handle all forms of agricultural by-products generated for a given enterprise. In addition, the components must be compatible and integrated within the system. All components should be designed to be simple, manageable, and durable, and they should require low maintenance. In this chapter, components are discussed under section headings that describe the function that they are to accomplish.

#### (c) Design, installation, and operation

Any facility must be designed and installed according to locally acceptable engineering standards and regulatory requirements. Proper operation and maintenance are required to achieve desired results. The design must address the methods of production, collection, storage, treatment, transfer, and utilization.

## 651.1001 Production

Components that affect the volume and consistency of agricultural waste produced are included in the production function. Roof gutters and downspouts and diversion to exclude clean water from areas of waste are examples of components that reduce the volume of waste material that needs management. Fences and walls that facilitate collection of waste confine the animals, thus increase the volume.

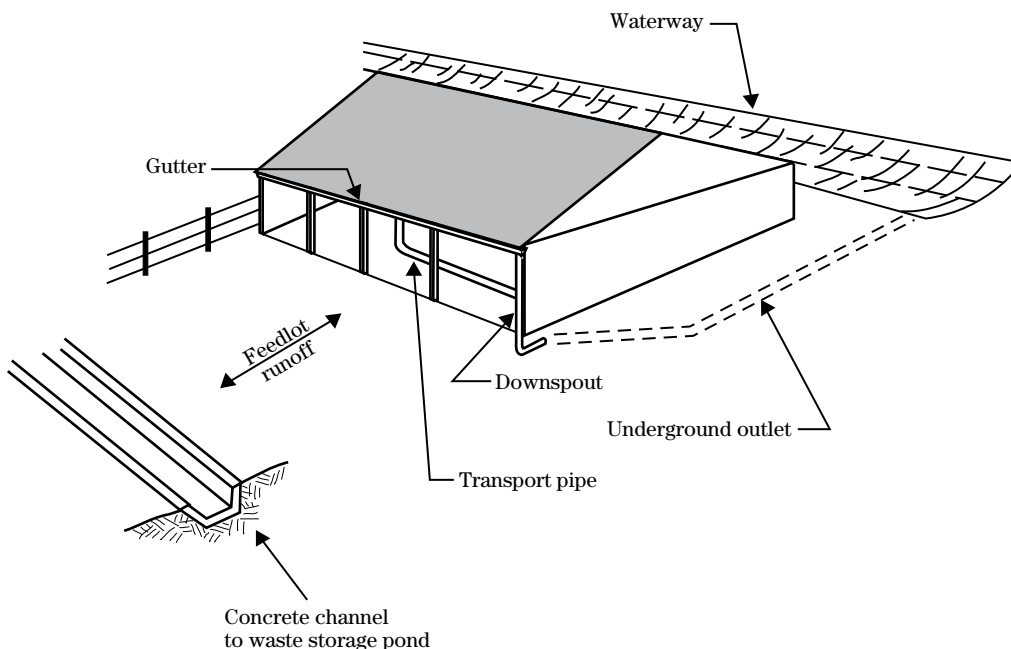
### (a) Roof runoff management

Roof runoff should be diverted from feedlots and manure storage areas unless it is needed for some use, such as dilution water for waste storage ponds or treatment lagoons. This can be accomplished by roof gutters and downspouts with underground or open channel outlets (fig. 10–1). Roof runoff structures should be planned and designed according to NRCS Conservation Practice Standard 588, Roof Runoff Structure. Gutters and downspouts may not be needed if the roof drainage will not come into contact with areas accessible to livestock.

The area of a roof that can be served by a gutter and downspout system is controlled by either the flow capacity of the gutter (channel flow) or by the capacity of the downspout (orifice flow). The gutter's capacity may be computed using Manning's equation. Design of a gutter and downspout system is based on the runoff from a 10-year frequency, 5-minute rainfall except that a 25-year frequency, 5-minute rainfall is used for exclusion of roof runoff from waste treatment lagoons, waste storage ponds, or similar practices.

Rainfall intensity maps are in appendix 10B. Caution should be used in interpolating these maps. Rainfall probabilities are based on measured data at principal weather stations that are mostly in populated regions. The 10-year, 5-minute rainfall in the 11 Western States was based on NOAA Atlas 1, and that in the 37 Eastern States was based on the National Weather Service HYDRO 35. Both of these publications state their limitations in areas of orographic effect. In the Western States, the 10-year, 5-minute rainfall generally is larger in mountain ranges than in valleys. Rainfall in all mountain ranges could not be shown on these maps because of the map scale and readability considerations. Many of these differences were in the range of 0.05 inch and fall within the contour interval of 0.10 inch.

**Figure 10–1** Roof gutter and downspout



A procedure for the design of roof gutters and downspouts follows:

*Step 1* Compute the capacity of the selected gutter size. This may be computed using Manning's equation. Using the recommended gutter gradient of 1/16 inch per foot and a Manning's roughness coefficient of 0.012, this equation can be expressed as follows:

$$q_g = 0.01184 \times A_g \times r^{0.67}$$

where:

$q_g$  = capacity of gutter, ft<sup>3</sup>/s

$A_g$  = cross-sectional area of gutter, in<sup>2</sup>

$r$  =  $A_g / wp$ , in

$wp$  = wetted perimeter of gutter, in

*Step 2* Compute capacity of downspout. Using an orifice discharge coefficient of 0.65, the orifice equation may be expressed as follows:

$$q_d = 0.010457 \times A_d \times h^{0.5}$$

where:

$q_d$  = capacity of downspout, ft<sup>3</sup>/s

$A_d$  = cross-sectional area of downspout, in<sup>2</sup>

$h$  = head, in (generally the depth of the gutter minus 0.5 in)

*Step 3* Determine whether the system is controlled by the gutter capacity or downspout capacity and adjust number of downspouts, if desired.

$$N_d = \frac{q_g}{q_d}$$

where:

$N_d$  = number of downspouts

If  $N_d$  is less than 1, the system is gutter-capacity controlled. If it is equal to or greater than 1, the system is downspout-capacity controlled unless the number of downspouts is equal to or exceeds  $N_d$ .

*Step 4* Determine the roof area that can be served based on the following equation:

$$A_r = \frac{q \times 3,600}{P}$$

where:

$A_r$  = area of roof served, ft<sup>2</sup>

$q$  = capacity of system, either  $q_g$  or  $q_d$ , whichever is smallest, ft<sup>3</sup>/s

$P$  = 5-minute precipitation for appropriate storm event, in

This procedure is a trial and error process. Different sizes of gutters and downspouts should be evaluated along with multiple downspouts to determine the best gutter and downspout system to serve the roof area involved.

**Design example 10–1     Gutters and downspouts**

Mrs. Linda Worth of Pueblo, Colorado, has requested assistance in developing an agricultural waste management system for her livestock operation. The selected alternatives include gutters and downspouts for a barn having a roof with a horizontally projected area of 3,000 square feet. The 10-year, 5-minute precipitation is 0.5 inch. The procedure above is used to size the gutter and downspouts.

*Step 1* Compute the capacity of the selected gutter size. Try a gutter with a 6-inch depth and 3-inch bottom width. One side wall is vertical, and the other is sloping, so the top width of the gutter is 7 inches. Note that a depth of 5.5 inches is used in the computations to allow for 0.5 inch of freeboard.

$$A_g = (3 \times 5.5) + (0.5 \times 3.67 \times 5.5)$$

$$= 26.6 \text{ in}^2$$

$$wp = 3 + 5.5 + (3.67^2 + 5.5^2)^{0.5}$$

$$= 15.1 \text{ in}$$

$$r = \frac{A_g}{wp}$$

$$= \frac{26.6}{15.1}$$

$$= 1.76 \text{ in}$$

$$q_g = 0.01184 \times A_g \times r^{0.67}$$

$$= 0.01184 \times 26.6 \times 1.76^{0.67}$$

$$= 0.46 \text{ ft}^3/\text{s}$$

*Step 2* Compute capacity of downspout. Try a 3-inch-diameter downspout.

$$H = \text{depth of gutter} - 0.5 \text{ in}^2$$

$$= 5.5 \text{ in}$$

$$A_d = 3.1416 \times \left(\frac{3}{2}\right)^2$$

$$= 7.07 \text{ in}^2$$

$$q_d = 0.010457 \times 7.07 \times 5.5^{0.5}$$

$$= 0.17 \text{ ft}^3/\text{s}$$

*Step 3* Determine whether the system is controlled by the gutter capacity or downspout capacity and make adjustments to number of downspouts if desired. By inspection, it can be determined that the gutter capacity (0.46 ft<sup>3</sup>/s) exceeds the capacity of one downspout (0.17 ft<sup>3</sup>/s). Unless a larger downspout or additional downspouts are used, the system capacity would be limited to the capacity of the downspout. Try using multiple downspouts. Determine number required to take advantage of gutter capacity.

$$N_d = \frac{q_g}{q_d}$$

$$= \frac{0.46}{0.17}$$

$$= 2.7$$

$N_d$  is greater than 1; therefore, with one downspout, the system would be downspout controlled. With three, it would be controlled by the gutter capacity, or 0.46 cubic feet per second. Use three downspouts to take full advantage of gutter capacity.

*Step 4* Determine the roof area that can be served based on the following equation:

$$A_r = \frac{q \times 3,600}{P}$$

$$= \frac{0.46 \times 3,600}{0.5}$$

$$= 3,312 \text{ ft}^2$$

This exceeds the roof area to be served; therefore, the gutter dimension selected and the three downspouts with dimensions selected are okay.



## (b) Runoff control

Essentially all livestock facilities in which the animals are housed in open lots or the manure is stored in the open must deal with runoff. Clean runoff from land surrounding livestock facilities should be diverted from barns, open animal concentration areas, and manure storage or treatment facilities (fig. 10-2). Runoff from feedlots should be channeled into manure storage facilities.

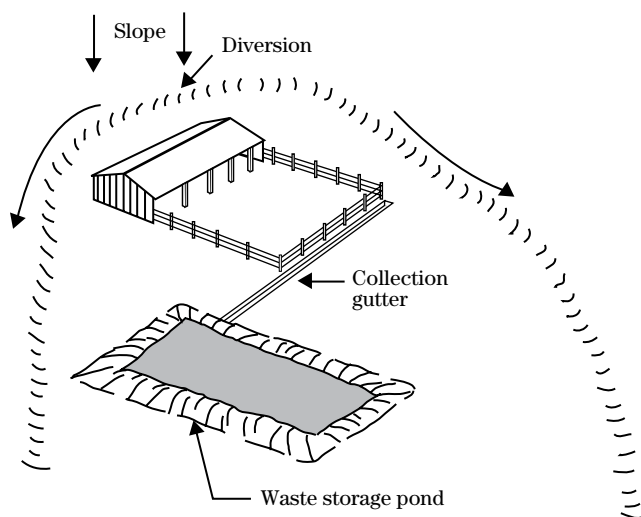
Appendix 10C presents a series of maps indicating the amount of runoff that can be expected throughout the year for paved and unpaved feedlot conditions. Clean runoff should be estimated using information in chapter 2 of the NRCS NEH 650, Engineering Field Handbook or by some other hydrologic method.

Diversions are to be designed according to NRCS Conservation Practice Standard 362, Diversion. Diversion channels must be maintained to remain effective. If vegetation is allowed to grow tall, the roughness increases and the channel velocity decreases, causing possible channel overflow. Therefore, vegetation should be periodically mowed. Earth removed by erosion from earthen channels should be replaced. Unvegetated, earthen channels should not be used in regions of high precipitation because of potential erosion.

## (c) Air quality considerations

Emissions of several pollutants from agricultural waste management systems can also affect air quality, including particulate matter (dust), odors, and other gases. Proper planning, design, operation, and maintenance of the agricultural waste management system can help to alleviate these air quality impacts. Siting of the system can significantly affect air quality. A manure storage facility should be located as far as possible from neighboring homes. Local and State regulatory agencies usually require a minimum distance. In addition, the facility should utilize terrain, vegetation, and meteorology to direct emissions away from nearby housing. Livestock may be adversely affected by high concentrations of gases, especially during manure agitation and pumping. Proper sanitation, housekeeping, feed additives, and moisture control, as well as frequent removal and land application of manure from buildings and storage facilities, can reduce emissions of dust, odors, and other gases, in addition to minimizing fly production.

**Figure 10-2** Diversion of clean water around feedlot



## 651.1002 Collection

Livestock and poultry manure collection often depends on the degree of freedom that is allowed the animal. If animals are allowed freedom of movement within a given space, the manure produced will be deposited randomly. Typically, the manure must be collected for transportation to storage or treatment. Also, the design and operation of the facility affects whether the manure is collected as a solid, semisolid (slurry), or liquid. For example, a scrape system will contain more concentrated manure, while a flush system may produce a more dilute mixture.

*Solid:* (>20% solids content) Manure with higher solids content is usually collected with a scraper or front-end loader and stored in a dry stack facility. The solids content can be increased by drying and/or adding bedding material.

*Liquid:* (<10% solids content) Liquid manure is usually collected and transported by pumping into a storage pond or lagoon. Dilution water or solids-liquid separation is usually required to achieve the low solids content.

*Semisolid or slurry:* (10–20% solids content) Fresh manure is usually a semisolid. It can be pumped with a large diameter manure pump or collected by a vacuum pump. Solid-liquid separation may allow for easier management of the solids and liquids separately.

Descriptions of components that provide efficient collection of animal waste include paved alleys, gutters, and slatted floors with associated mechanical and hydraulic equipment follow.

### (a) Alleys

Alleys are paved areas where the animals walk. They generally are arranged in straight lines between animal feeding and bedding areas. On slatted floors, animal hoofs work the manure through the slats into the alleys below, and the manure is collected by flushing or scraping the alleys.

### (1) Scrape alleys and open areas

Two kinds of manure scrapers are used to clean alleys (fig. 10–3). A mechanical scraper is dedicated to a given alley. It is propelled using electrical drives attached by cables or chains. The drive units are often used to power two mechanical scrapers that are traveling in opposite directions in parallel alleys in an oscillating manner. Some mechanical scrapers are in alleys under slatted floors.

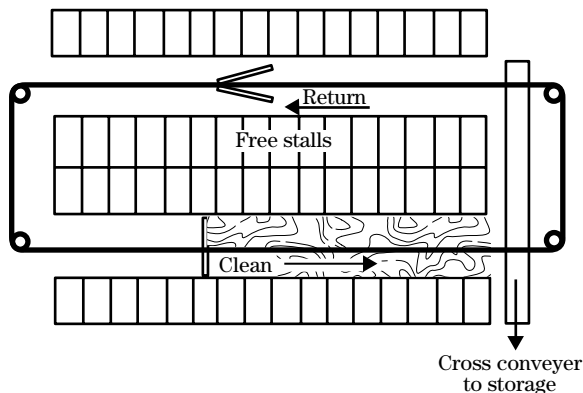
A tractor scraper can be used in irregularly shaped alleys and open areas where mechanical scrapers cannot function properly. It can be a blade attached to either the front or rear of a tractor or a skid-steer tractor that has a front-mounted bucket.

The width of alleys depends on the desires of the producer and the width of available equipment. Scrape alley widths typically vary from 8 to 14 feet for dairy and beef cattle and from 3 to 8 feet for swine and poultry.

### (2) Flush alleys

Alleys can also be cleaned by flushing. Grade is critical and can vary between 1.25 and 5 percent. It may change for long flush alleys. The alley should be level perpendicular to the centerline. The amount of water used for flushing is also critical. An initial flow depth of 3 inches for underslat gutters and 4 to 6 inches for open alleys is necessary.

**Figure 10–3** Scrape alley used in dairy barns



The length and width of the flush alley are also factors. Most flush alleys should be less than 200 feet long. The width generally varies from 3 to 10 feet depending on animal type. For underslat gutters and alleys, channel width should not exceed 4 feet. The width of open flush alleys for cattle is frequently 8 to 10 feet.

Flush alleys and gutters should be cleaned at least twice per day. For pump flushing, each flushing event should have a minimum duration of 3 to 5 minutes, at a flow rate between 5 and 10 feet per second.

Tables 10-1 and 10-2 indicate general recommendations for the amount of flush volume. Table 10-3 gives the minimum slope required for flush alleys and gutters. Figures 10-4 and 10-5 illustrate flush alleys.

**Table 10-1** Recommended total daily flush volumes (MWPS 1985)

Animal type	Gal/head
Swine	
Sow and litter	35
Pre-nursery pig	2
Nursery pig	4
Growing pig	10
Finishing pig	15
Gestating sow	25
Dairy cow	100
Beef feeder	100

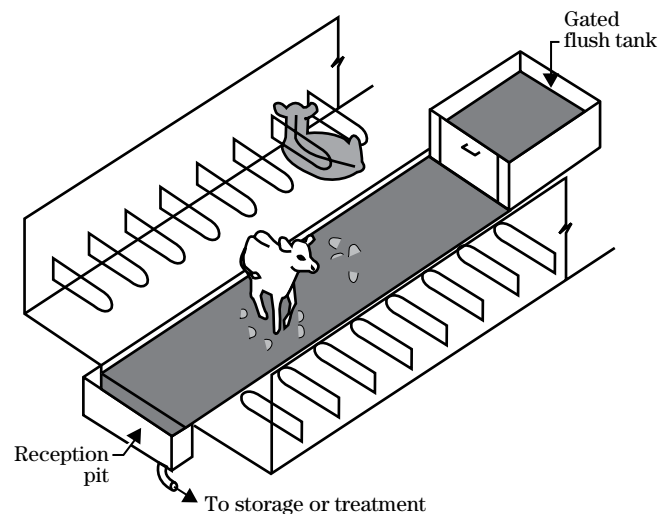
**Table 10-2** Flush tank volumes and discharge rates (MWPS 1985)

Initial flow depth, in	Tank volume, gal/ft of gutter width	Tank discharge rate, gal/min/ft of gutter width	Pump discharge, gal/min/ft of gutter width
1.5	30	112	55
2.0	40	150	75
2.5	45	195	95
3.0	55	255	110
4.0	75	615	150
5.0	100	985	175
6.0	120	1,440	200

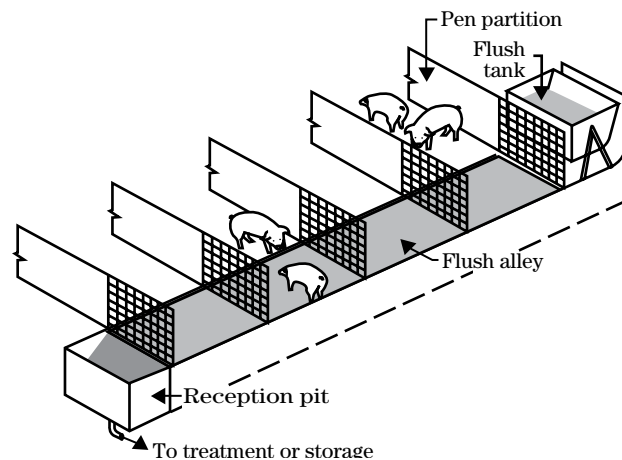
**Table 10-3** Minimum slope for flush alleys (MWPS 1985)

	Underslat alley	Open alley narrow width (<4 ft)			Open alley wide width (>4 ft)		
		1.5	2.0	2.5	4.0	5.0	6.0
Initial flow depth, in	3.0	1.5	2.0	2.5	4.0	5.0	6.0
Slope, %	1.25	2.0	1.5	1.25	5.0	4.0	3.0

**Figure 10-4** Dairy flush alley



**Figure 10-5** Swine flush alley



Several mechanisms are used for flushing alleys. The most common rapidly empties large tanks of water or use high-volume pumps. Several kinds of flush tanks are used (fig. 10-6). One known as a tipping tank pivots on a shaft as the water level increases. At a certain design volume, the tank tips, emptying the entire amount in a few seconds, which causes a wave that runs the length of the alley.

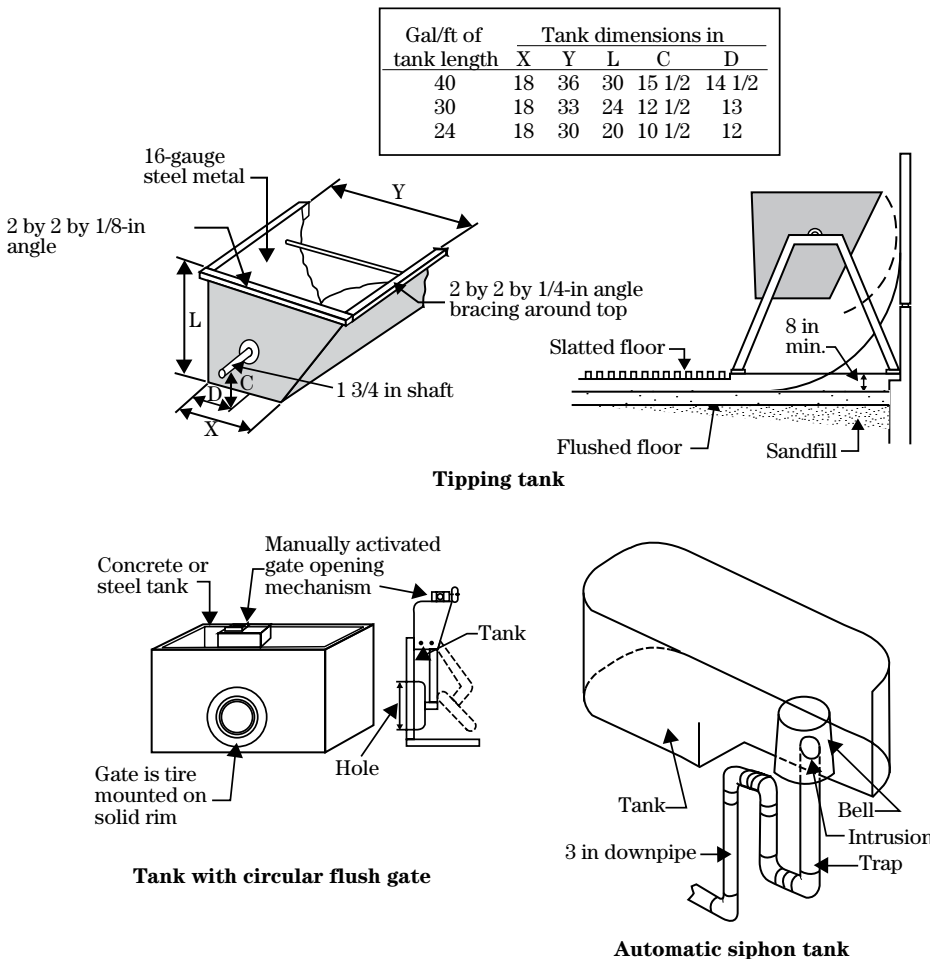
Some flush tanks have manually opened gates. These tanks are emptied by opening a valve, standpipe, pipe plug, or flush gate. Float switches can be used to control flushing devices.

Another kind of flush tank uses the principle of a siphon. In this tank, the water level increases to a given

point where the head pressure of the liquid overcomes the pressure of the air trapped in the siphon mechanism. At this point the tank rapidly empties, causing the desired flushing effect.

Most flush systems use pumps to recharge the flush tanks or to supply the necessary flow if the pump flush technique is used. Centrifugal pumps typically are used. The pumps should be designed for the work that they will be doing. Low volume pumps (10-150 gal/min) may be used for flush tanks, but high volume pumps (200 to 1,000 gal/min) are needed for alley flushing. Pumps should be the proper size to produce the desired flow rate. Flush systems may rely on recycled lagoon water for the flushing liquid.

**Figure 10-6** Flush tanks



In some parts of the country where effluent is recycled from lagoons for flushwater, salt crystals (struvite) may form inside pipes and pumps and cause decreased flow. Use of plastic pipe, fittings, and pumps that have plastic impellers can reduce the frequency between cleaning or replacing pipes and pumps. If struvite formation is anticipated, recycle systems should be designed for periodic clean out of pumps and pipe. A mild acid, such as dilute hydrochloric acid (1 part 20 mole hydrochloric acid to 12 parts water), can be used. A separate pipe may be needed to accomplish acid recycling. The acid solution should be circulated throughout the pumping system until normal flow rates are restored. The acid solution should then be removed. Caution should be exercised when disposing of the spent acid solution to prevent ground or surface water pollution.

## (b) Gutters

Gutters are narrow trenches used to collect manure and bedding. They are often employed in confined stall dairy barns and in some swine facilities.

### (1) Gravity drain gutters

Deep, narrow gutters can be used in swine finishing buildings (fig. 10-7). These gutters are at the lowest elevation of the pen. The animal traffic moves the waste to the gutter. The gutter fills and is periodically emptied. Gutters that have Y, U, V, or rectangular cross-sectional shapes are used in farrowing and nursery swine facilities. These gutters can be gravity drained periodically.

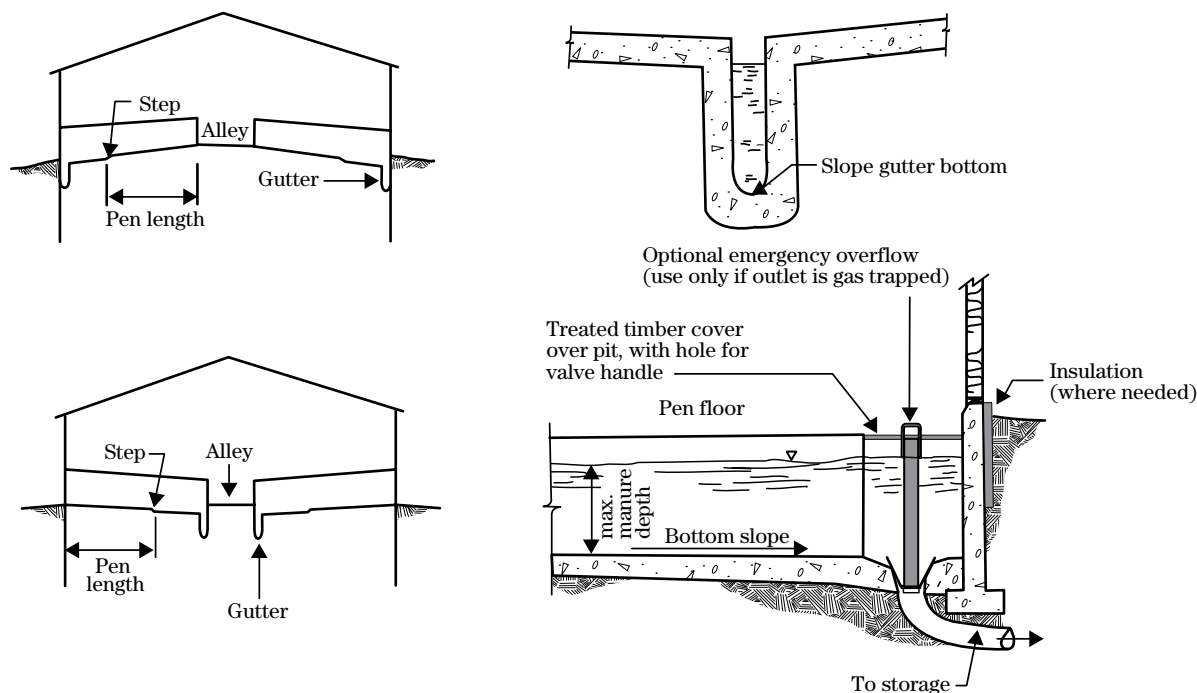
### (2) Step-dam gutters

Step-dam gutters, also known as gravity gutters or gravity flow channels provide a simple alternative for collecting dairy manure (fig. 10-8). A 6-inch-high dam holds back a lubricating layer of manure in a level, flat-bottomed channel. Manure drops through a floor grate or slats and flows down the gutter under its own weight. The gutter is about 30 inches wide and steps down to a deeper cross channel below the dam.

### (3) Scrape gutters

Scrape gutters are frequently used in confined stall dairy barns. The gutters are 16 to 24 inches wide, 12 to 16 inches deep, and generally do not have any bottom

**Figure 10-7** Flush and gravity flow gutters for swine manure



slope. They are cleaned using either shuttle-stroke or chain and flight gutter cleaners (figs. 10-9 and 10-10). Electric motor driven shuttle stroke gutter cleaners have paddles that pivot on a drive rod. The drive rod travels alternately forward for a short distance and then backwards for the same distance. The paddles are designed to move manure forward on the forward stroke and to collapse on the drive rod on the return stroke. This action forces the manure down the gutter. Shuttle stroke gutter cleaners can only be used on straight gutters.

Chain and flight scrapers are powered by electric motors and are used in continuous loops to service one or more rows of stalls.

#### (4) Flush gutters

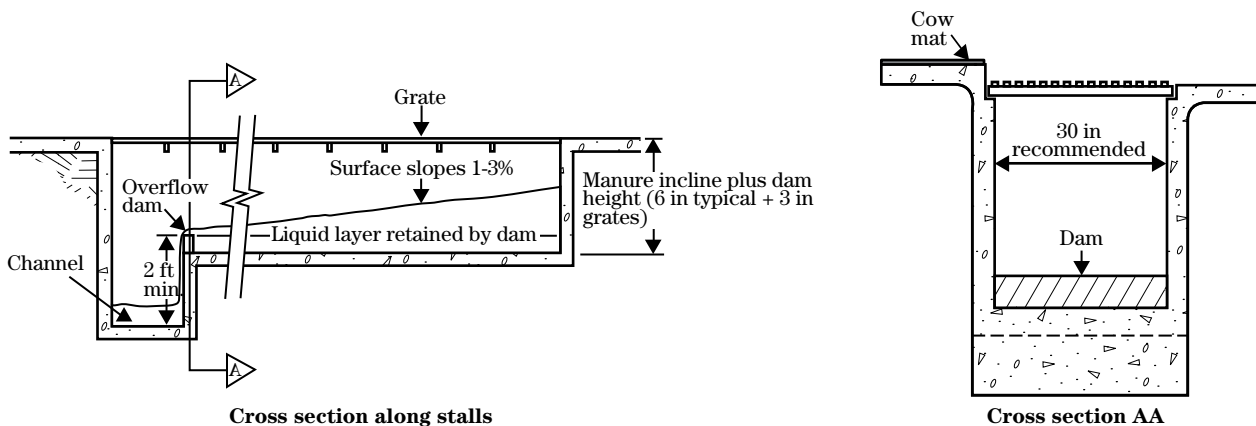
Narrow gutters can also be cleaned by flushing. Flush gutters are usually a minimum of 2 feet deep on the shallow end. The depth may be constant or increase as the length of the gutter increases. The bottom grade can vary from 0 to 5 percent depending on storage requirements and clean out technique. Flushing tanks or high volume pumps may be used to clean flush gutters (refer to the section on flush alternatives for alleys).

#### (c) Slatted floors

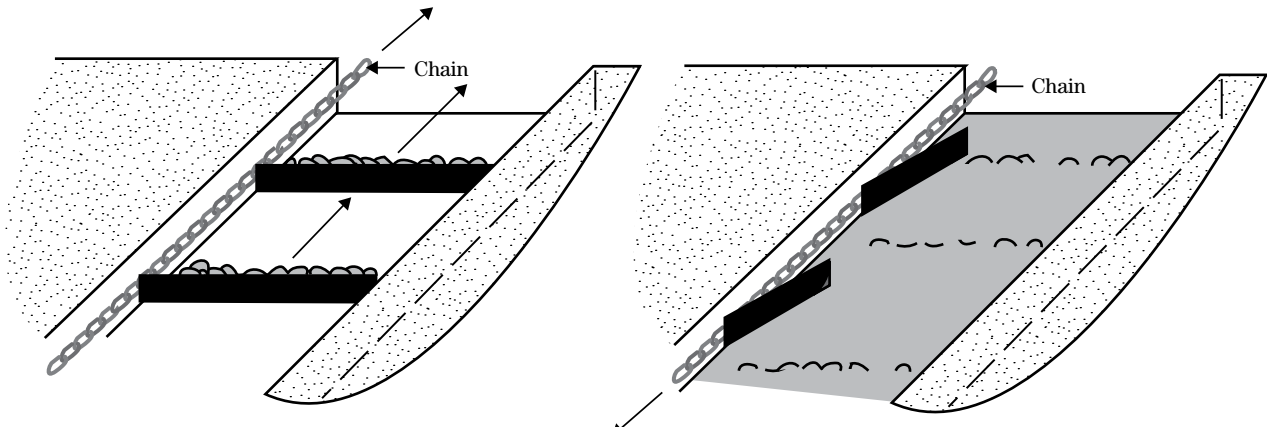
Manure and bedding are worked through the slats by the animal traffic into a storage tank or alley below. Most slats are constructed of reinforced concrete (fig. 10-11); however, some are made of wood, plastic, or aluminum. They are manufactured either as individual units or as gangs of several slats. Common slat openings range from  $\frac{3}{8}$  to  $1\frac{3}{4}$  inches, depending on animal type. For swine, openings between  $\frac{3}{8}$  and  $\frac{3}{4}$  inch are not recommended.

Slats are designed to support the weight of the slats plus the live loads (animals, humans, and mobile equipment) expected for the particular facility. Reinforcing steel is required in concrete slats to provide needed strength.

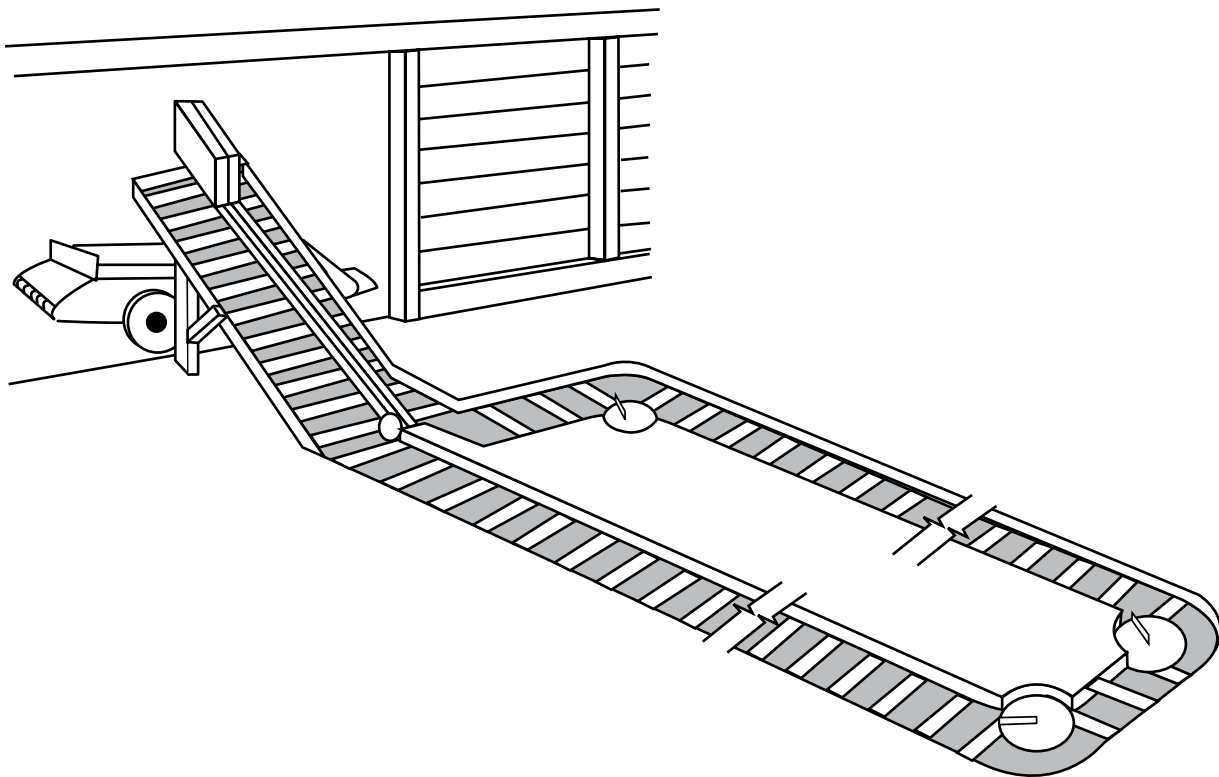
**Figure 10-8** Gravity gutter for dairy manure



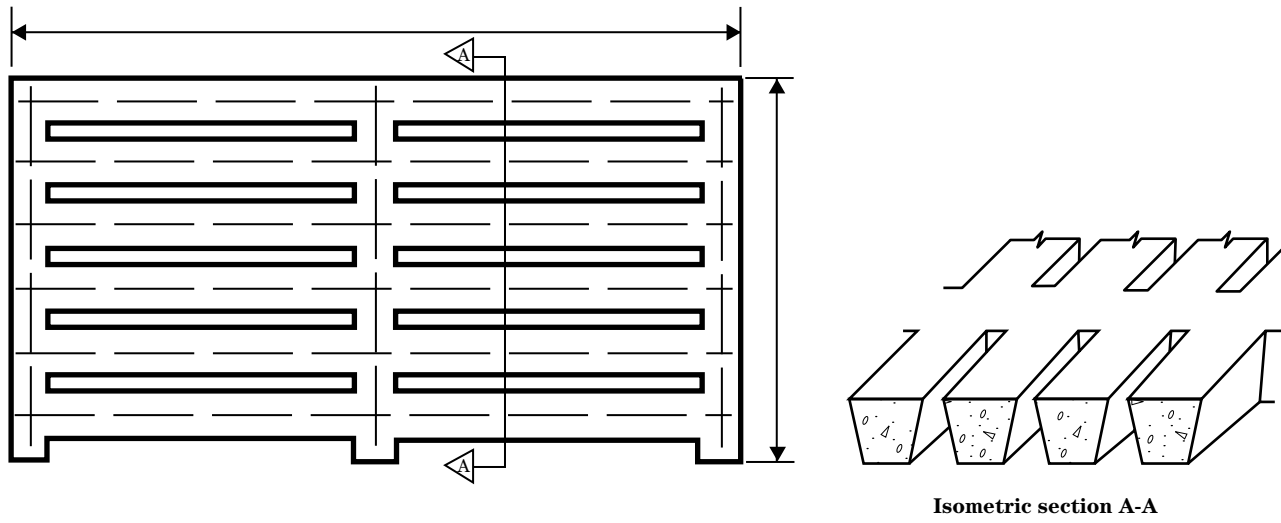
**Figure 10-9** Shuttle-stroke gutter cleaner



**Figure 10-10** Chain and flight gutter cleaner



**Figure 10-11** Concrete gang slats





## 651.1003 Transfer

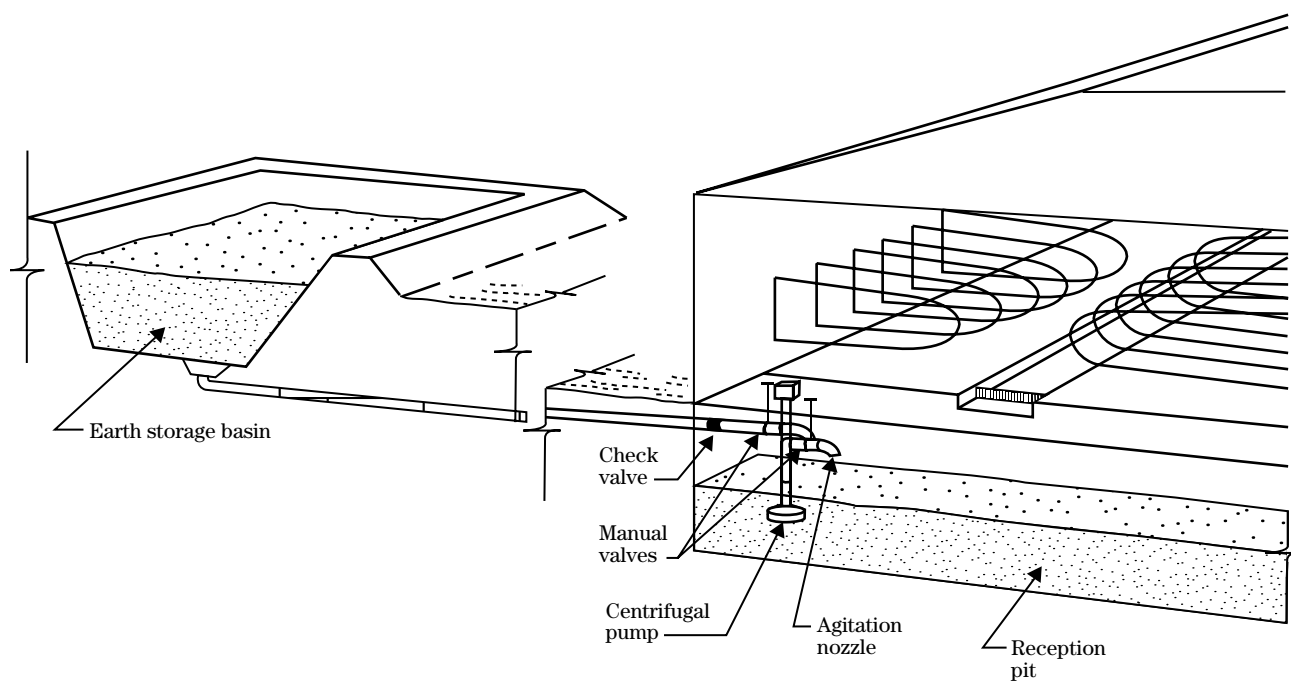
Manure collected from within a barn or confinement area must be transferred to the storage or treatment facility. In the simplest system, the transfer component is an extension of the collection method. More typically, transfer methods must be designed to overcome distance and elevation changes between the collection and storage facilities. In some cases, gravity can be used to move the manure. In many cases, however, mechanical equipment is needed to move the manure. Transfer also involves movement of the material from storage or treatment to the point of utilization. This may involve pumps, pipelines, and tank wagons. Transfer systems should be planned and designed in accordance with NRCS Conservation Practice Standard 634, Waste Transfer.

### (a) Reception pits

Slurry and liquid manure collected by scraping, gravity flow, or flushing are often accumulated in a reception pit (fig. 10–12). Feedlot runoff can also be accumulated. These pits can be sized to hold all the manure produced for several days to improve pump efficiency or to add flexibility in management. Additional capacity might be needed for extra liquids, such as milk parlor water or runoff from precipitation. For example, if the daily production of manure and parlor cleanup water for a dairy is estimated at 2,500 gallons and 7 days of storage is desired, then a reception pit that has a capacity of 17,500 gallons ( $2,500 \text{ gal/d} \times 7 \text{ d}$ ) is the minimum required. Additional volume should be allowed for freeboard emergency storage.

Reception pits are rectangular or circular and are often constructed of cast-in-place reinforced concrete or reinforced concrete block. Reinforcing steel must be added so that the walls withstand internal and external loads.

**Figure 10–12** Reception pit for dairy freestall barn



Manure can be removed with pumps or by gravity. Centrifugal pumps can be used for agitating and mixing before transferring the material. Both submersible pumps and vertical shaft pumps that have the motor located above the manure can be used. Diluted manure can be pumped using submersible pumps, often operated with float switches. The entrance to reception pits should be restricted by guard rails or covers.

Debris, such as pieces of metal and wood and rocks, must sometimes be removed from the bottom of a reception pit. Most debris must be removed manually, but if possible, this should be done remotely from outside the pit. The pit should be well ventilated before entering. If manure is in the pit, a self-contained breathing apparatus must be used. Short baffles spaced around the pump intake can effectively guard against debris clogging the pump.

In cold climates, reception pits need to be protected from freezing. This can be accomplished by covering or enclosing it in a building. Adequate ventilation must be provided in all installations. In some installations, hoppers and either piston pumps or compressed air pumps are used instead of reception pits and centrifugal pumps. These systems are used with semisolid manure that does not flow readily or cannot be handled using centrifugal pumps.

## (b) Gravity flow pipes

Liquid and slurry manure can be moved by gravity if sufficient elevation differences are available or can be established. For slurry manure, a minimum of 2 feet of elevation head should exist between the top of the collection pit or hopper and the surface of the material in storage when storage is at maximum design depth.

Gravity flow slurry manure systems typically use 18- to 36-inch-diameter pipe. In some parts of the country, 4- to 8-inch-diameter pipe is used for the gravity transport of low (<3%) total solid (TS) concentration waste. The planner/designer should exercise caution when specifying the 4- to 8-inch pipe. Smooth steel, plastic, concrete, and corrugated metal pipe are used. Metal pipes should be coated with asphalt or plastic to retard corrosion, depending upon the type of metal. All joints must be sealed so that the pipe is water tight.

Gravity flow pipes should be designed to minimize changes in grade or direction over the entire length. Pipe slopes that range from 4 to 15 percent will work satisfactorily, but 7 to 8 percent slope is preferable. Excessive slopes allow separation of liquids and solids and increase the chance of plugging. The type and quantity of bedding and the amount of milkhouse waste and wash water added have an effect on the flow characteristics and the slope needed in a particular situation. Straw bedding should be discouraged, especially if it is not chopped. Smooth, rounded transition from reception pit to pipe and the inclusion of an air vent in the pipeline aid the flow and prevent plugging.

Figure 10–13 illustrates the use of gravity flow for manure transfer. At least two valves should be located in an unloading pipe. Proper construction and operation of gravity unloading waste storage structures are extremely important. Containment berms should be considered if the contamination risk is high downslope of the unloading facility.

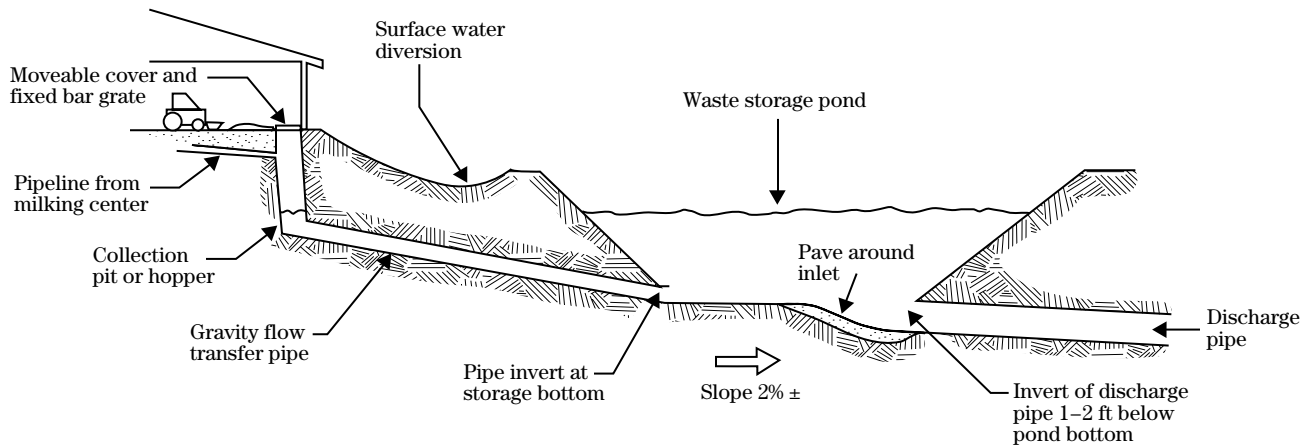
## (c) Push-off ramps

Manure that is scraped from open lots can be loaded into manure spreaders or storage and treatment facilities using push-off ramps (fig. 10–14) or docks. A ramp is a paved structure leading to a manure storage facility. It can be level or inclined and usually includes a retaining wall. A dock is a level ramp that projects into the storage or treatment facility. Runoff should be directed away from ramps and docks unless it is needed for waste dilution. Ramp slopes should not exceed 5 percent. Push-off ramps and docks should have restraints at each end to prevent the scraping tractors from accidentally going off the end.

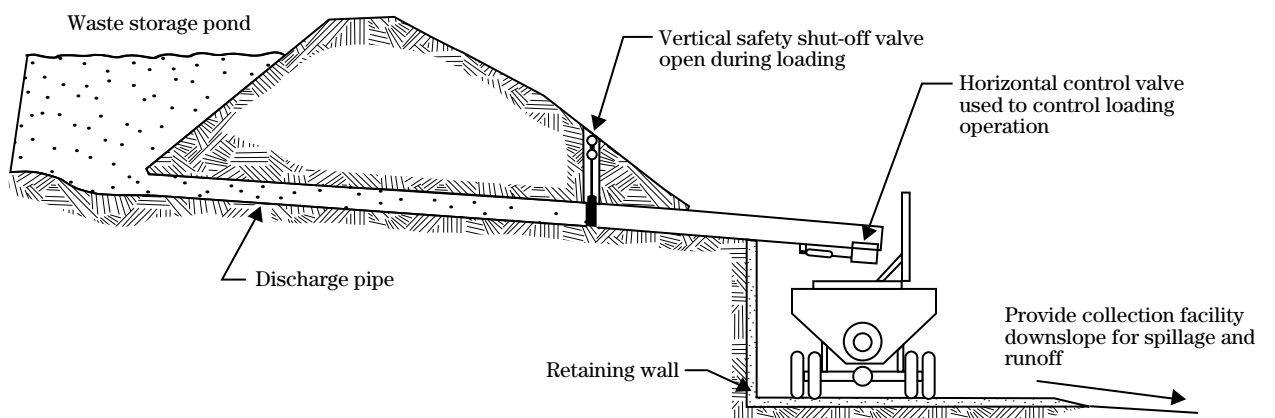
## (d) Pumps

Most liquid manure handling systems require one or more pumps to either transport or agitate manure. Pumps are in two broad classifications—displacement and centrifugal. The displacement group includes piston, air pressure transfer, diaphragm, and progressive cavity pumps. The first two are used only for transferring manure; however, diaphragm and progressive cavity pumps can be used for transferring, agitating, and irrigating manure.

**Figure 10-13** Examples of gravity flow transfer



**Gravity flow transfer**



**Gravity flow from storage**

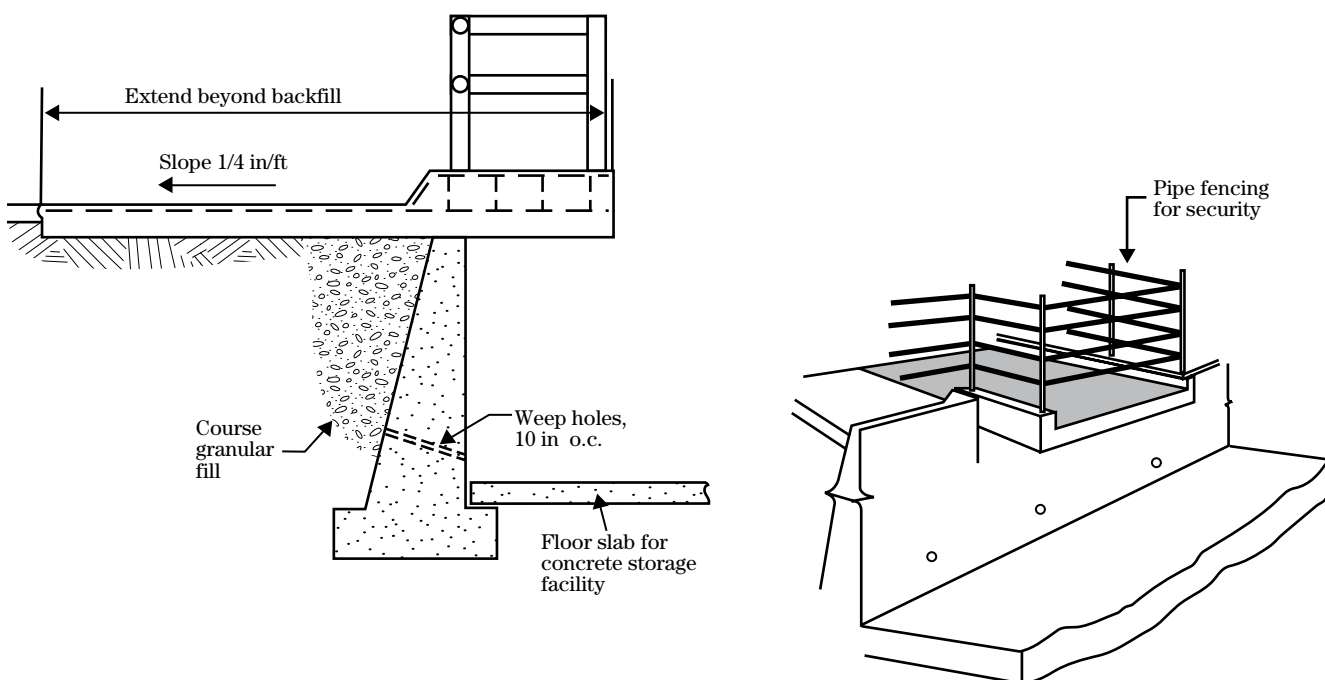
The centrifugal group includes vertical shaft, horizontal shaft, and submersible pumps. They can be used for agitation and transfer of liquid manure; however, only vertical and horizontal shaft pumps are used for irrigation because of the head that they can develop.

Pump selection is based on the consistency of the material to be handled, the total head to be overcome, and the desired capacity (pumping rate). Pump manufacturers and suppliers can provide rating curves for a variety of pumps.

### (e) Equipment

Other equipment used in the transfer of agricultural by-product includes a variety of pumps including chopper/agitator, centrifugal, ram, and screw types. Elevators, pipelines, and hauling equipment are also used. See Agricultural Waste Management Field Handbook (AWMFH), 651.12 for information about specific equipment.

**Figure 10-14** Push-off ramp



## 651.1004 Storage

Manure generally must be stored so that it can be used when conditions are appropriate. Storage facilities for manure of all consistencies must be designed to meet the requirements of a given enterprise.

Determining the storage period for a storage facility is crucial to the proper management of a manure management system. If too short a period is selected, the facility may fill before the material can be used in an environmentally sound manner. Too long a period may result in an unjustified expenditure for the facility and loss of nutrient value.

Many factors are involved in determining the storage period. They include the weather, crop, growing season, equipment availability, soil, soil condition, labor requirements, and management flexibility. Generally, when nutrient utilization is by land application, a storage facility must be sized so that it can store the manure during the nongrowing season. A storage facility that has a longer storage period generally will allow more flexibility in managing the manure to accommodate weather variability, equipment availability, equipment breakdown, and overall operation management. Storage facilities should be planned and designed in accordance with NRCS Conservation Practice Standard 313, Waste Storage Facility.

### (a) Manure storage facilities for solids

Storage facilities for solid manure include storage ponds and storage structures. Storage ponds are earthen impoundments used to retain manure, bedding, and runoff liquid. Solid and semisolid manure placed into a storage pond will most likely have to be removed as a liquid unless precipitation is low or a means of draining the liquid is available. The pond bottom and entrance ramps should be paved if emptying equipment will enter the pond.

#### (1) Stacking facilities

Storage structures can be used for manure that will stack and can be handled by solid manure handling equipment. These structures must be accessible for loading and hauling equipment. They can be open or covered. Roofed structures are used to prevent or

reduce excess moisture content. Open stacks can be used in either arid or humid climate. Seepage and runoff from dry stack facilities must be managed. Structures for open and covered stacks often have wooden, reinforced concrete or concrete block sidewalls.

Some operations store the manure at the point of generation. Examples of dairy facilities include dry packs and hoop buildings. The amount of bedding material often dictates whether or not the manure can be handled as a solid. Poultry operations often store and compost the litter in-place between flocks. Only part of the cake may be removed before the next flock is introduced to the building.

In some instances, manure must be stored in open stacks in fields or within a feedlot. Runoff and seepage from these stacks must be managed to prevent movement into streams or other surface or ground water. Figures 10–15 and 10–16 show various solid manure storage facilities.

**Design considerations**—Storage facilities for solid manure must be designed correctly to ensure desired performance and safety. Considerations include materials selection, control of runoff and seepage, necessary storage capacity, and proper design of structural components such as sidewalls, floors, and roofs.

The primary materials used in constructing timber structures for solids storage are pressure-treated or rot-resistant wood and reinforced concrete. These materials are suitable for long-term exposure to manure without rapid deterioration. Structural grade steel is also used, but it corrodes and must be protected against corrosion or be periodically replaced. Similarly, high quality and protected metal fasteners must be used with timber structures to reduce corrosion problems.

Seepage and runoff, which frequently occur from manure stacks, must be controlled to prevent access into surface and ground water. One method of control is to channel any seepage into a storage pond. At the same time uncontaminated runoff, such as that from the roof and outside the animal housing and lot area, should be diverted around the site.

Concrete ramps are used to gain access to solid manure storage areas. Ramps and floors of solid manure storage structures need to be designed so that

handling equipment can be safely operated. Ramp slopes of 8 to 1 (horizontal to vertical) or flatter are considered safe. Slopes steeper than this are difficult to negotiate. Concrete pavement for ramps and storage units should be rough finished to aid in traction. Ramps need to be wide enough that equipment can be safely backed and maneuvered.

Factors to consider in the design of storage facilities for solids include type, number and size of animals, number of days storage desired, and the amount of bedding that will be added to the manure. Equation 10-1 can be used to calculate the manure storage volume:

$$VMD = AU \times DVM \times D \quad (\text{eq. 10-1})$$

where:

VMD = volume of manure production for animal type for storage period,  $\text{ft}^3$

AU = number of 1,000-pound animal units (AU) by animal type

DVM = daily volume of manure production for animal type,  $\text{ft}^3/\text{AU}/\text{d}$

D = number of days in storage period

The bedding volume to be stored can be computed using:

$$BV = \frac{FR \times WB \times AU \times D}{BUW} \quad (\text{eq. 10-2})$$

where:

FR = volumetric void ratio (ASAE 1982) (values range from 0.3 to 0.5)

WB = weight of bedding used for animal type,  $\text{lb}/\text{AU}/\text{d}$

BUW = bedding unit weight,  $\text{lb}/\text{ft}^3$

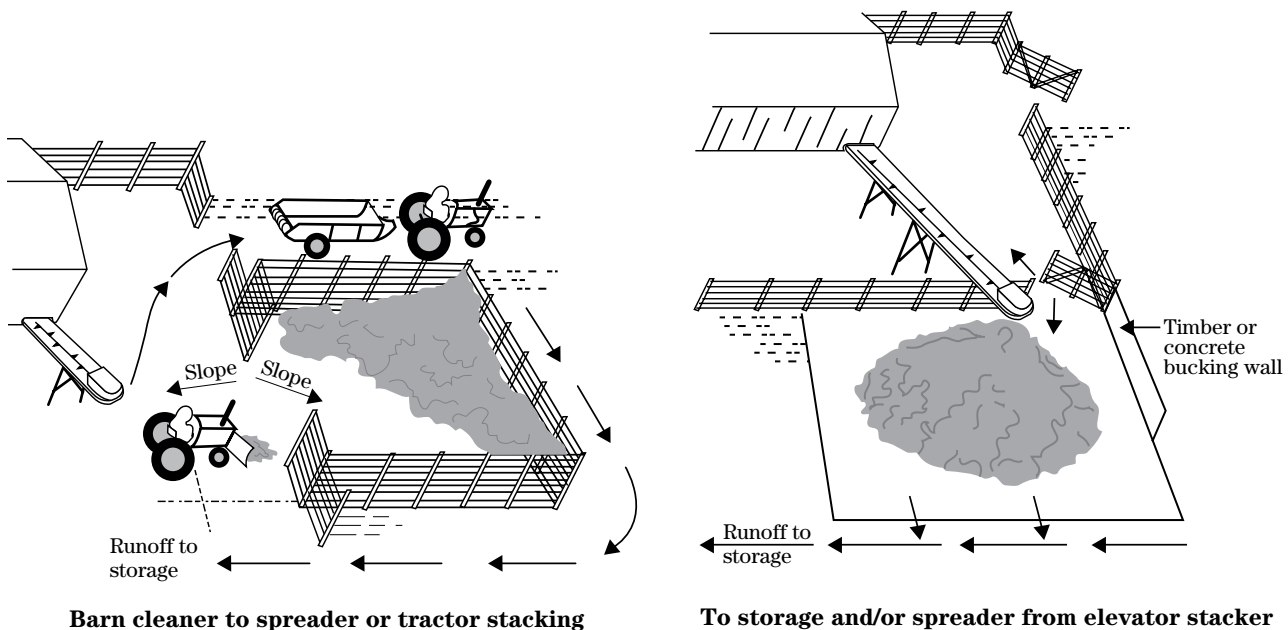
Using the recommended volumetric void ratio of 0.5, the equation becomes:

$$BV = \frac{0.5 \times WB \times AU \times D}{BUW}$$

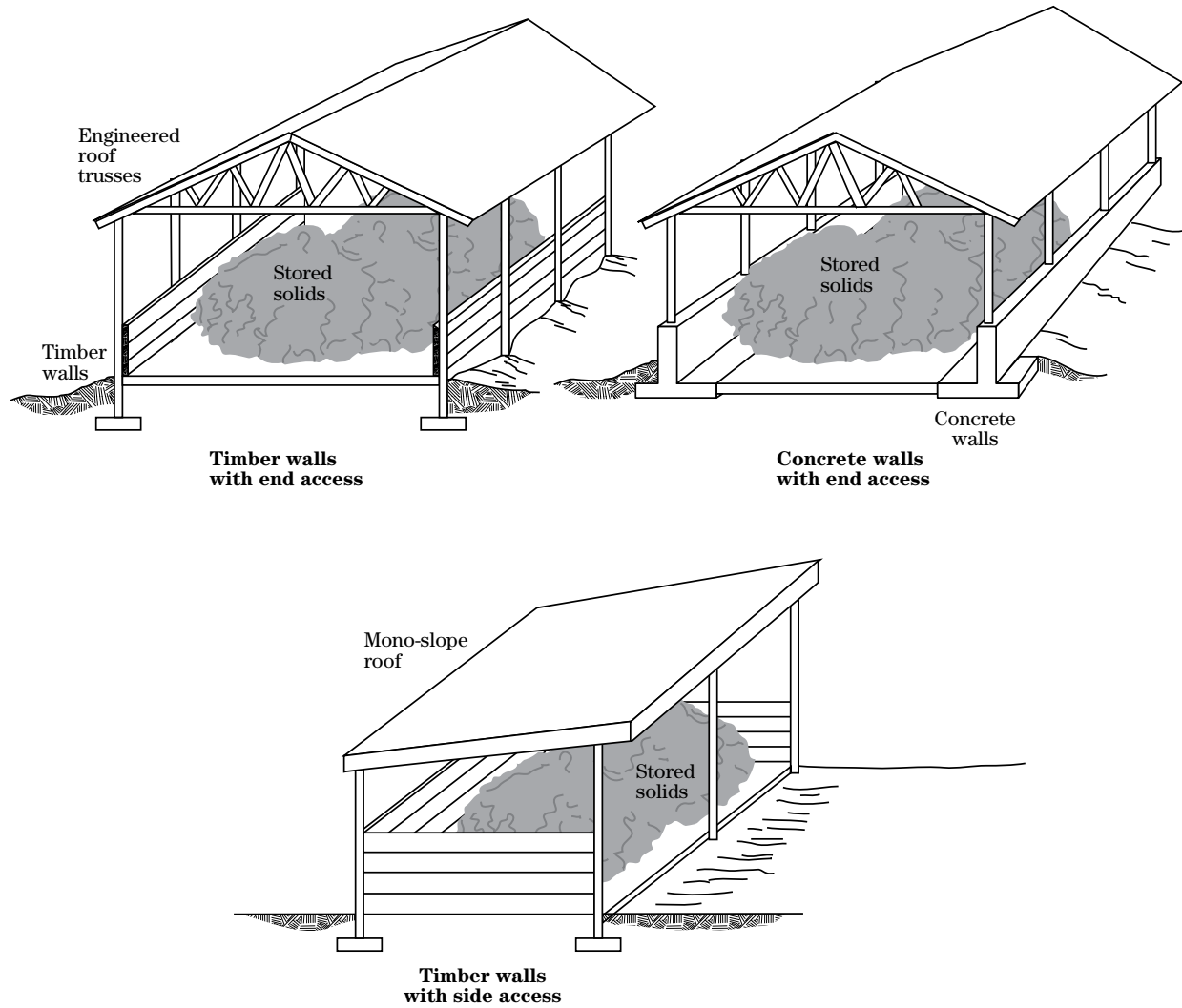
Characteristics of manure and bedding are described in AWMFH, chapter 4. Other values may be available locally or from the farmer or rancher.

Allowance must be made for the accumulation of precipitation that may fall directly into the storage. Contaminated runoff should be handled separately from a solid manure storage facility. Uncontaminated runoff should be diverted from the storage unit.

**Figure 10-15** Solid manure stacking facilities



**Figure 10-16** Roofed solid manure storage



**Design example 10–2 Waste stacking facility**

Mr. Ralph Kilpatrick of Hoot Ridge, Kentucky, has requested assistance in developing a manure management system. He selected an alternative that includes solid manure storage for his Holstein dairy herd of 52 heifers and 100 milking cows with an average milk production of 75 pounds per day. His nutrient management plan indicates the need for 90 days storage. He uses sawdust bedding for both the milking cows and the heifers. Because of space limitations, the storage can be no wider than 50 feet. He would prefer that the facility be stacked no more than 7 feet high. The structure will not be roofed, so stacking above sidewalls will not be considered in design. Determine the necessary volume and facility dimensions using worksheet 10A–1.

*Manure production*—the animal descriptions, average weight, and numbers are entered on lines 1 and 2. The number of equivalent animal unit (AU) for each animal type is calculated and entered on line 4. Daily manure production (line 4) is in table 4–5(b) of AWMFH, chapter 4. The number of days in storage is entered on line 6. The manure volume (line 7) is calculated using equation 10–1. Add the calculated manure volume for each animal type (VMD), and enter the sum (TVM) on line 8.

*Wastewater volume*—because this design example involves a waste stacking facility, it would not be appropriate to include wastewater in the storage facility. Therefore, lines 9, 10, and 11 are not involved in estimating the waste volume for this example.

*Bedding volume*—the weight of bedding used daily per animal unit for each animal type found in table 4–4 is entered on line 12. The bedding unit weight, which may be taken from table 4–3 in AWMFH, chap-

ter 4, is entered on line 13. The bedding volume for each animal type for the storage period is calculated using equation 10–2 and entered on line 14. The total bedding volume (TBV) is the sum of the bedding volume for all animal types. Sum the calculated bedding volume (BV) for each animal type and enter it on line 15.

*Waste volume*—the total waste volume (WV) (line 16) is the sum of the total manure production (TVM) and the total bedding volume (TBV). The storage width (WI) and height (H) can be adjusted for site conditions and common building procedures (usually dimensions divisible by 4 or 8), so the length (line 17) is calculated by trial and error using the equation:

$$L = \frac{WV}{WI \times H}$$

A waste storage structure for solids should be designed to withstand all anticipated loads. Loadings include internal and external loads, hydrostatic uplift pressure, concentrated surface and impact loads, water pressure because of the seasonal high water table, and frost or ice pressure.

The lateral earth pressure should be calculated from soil strength values determined from results of appropriate soil tests. If soil strength tests are not available, the minimum lateral earth pressure values indicated in the NRCS Conservation Practice Standard 313, Waste Storage Facility, are to be used.

Timber sidewalls for storage structures should be designed with the load on the post based on full wall height and spacing of posts.



## Worksheet 10A-1—Waste storage structure capacity design

Decisionmaker: <u>Ralph Kilpatrick</u>		Date: <u>6/13/91</u>
Site: <u>Hoot Ridge, KY</u>		
<b>Animal units</b>		
1. Animal type <u>Milkers Heifer</u>	3. Number of animals (N) <u>100 52</u>	
2. Animal weight, lbs (W) <u>1,400 1,000</u>	4. Animal units, $AU = \frac{W \times N}{1000} =$ <u>140 52</u>	
<b>Manure volume</b>		
5. Daily volume of daily manure production per AU, $ft^3/AU/day$ (DVM) = <u>1.7 0.9</u>	7. Total volume of manure production for animal type for storage period, $ft^3$ <u>21,420 4,212</u>	
6. Storage period, days (D) = <u>90</u>	8. Total manure production for storage period, $ft^3$ (TVM) <u>25,632</u>	
<b>Wastewater volume</b>		
9. Daily wastewater volume per AU, $ft^3/AU/day$ (DWW) = _____	11. Total wastewater volume for storage period, $ft^3$ (TWW) <u>0</u>	
10. Total wastewater volume for animal description for storage period, $ft^3$ <u>WWD = DWW x AU x D =</u> _____		
<b>Bedding volume</b>		
12. Amount of bedding used daily for animal type, lbs/AU/day (WB) = <u>3.1 3.1</u>	14. Bedding volume for animal type for storage period, $ft^3$ (BV) = <u>1,628 604</u>	
13. Bedding unit weight, lbs/ $ft^3$ (BUW) = <u>12</u>	15. Total bedding volume for storage period, $ft^3$ (TBV) = <u>2,232</u>	
<b>Waste volume requirement</b>		
16. Waste volume, $ft^3$ (WV) = TVM + TWW + TBV = <u>25,632 + 0 + 2,232 = 27,864</u>		
<b>Waste stacking structure sizing</b>		
17. Structure length, ft $L = \frac{WV}{WI \times H} =$ <u>79.6 (USE 84)</u>	19. Structure height, ft $H = \frac{WV}{L \times WI} =$ <u>7</u>	
18. Structure width, ft $WI = \frac{WV}{L \times H} =$ <u>47.4 (USE 48)</u>		
Notes for waste stacking structure:		
1. The volume determined (WV) does not include any volume for freeboard. It is recommended that a minimum of 1 foot of freeboard be provided for a waste stacking structure.		2. The equations for L, WI, and H assume manure is stacked to average height equal to the sidewall height. Available storage volume must be adjusted to account for these types of variations.
<b>Tank sizing</b>		
20. Effective depth, ft (EH)	22. Rectangular tank dimensions	
Total height (or depth) of tank desired, ft (H) ---- _____	Total height, ft (H) = _____ Selected width, ft (WI) = _____	
Less precipitation for storage period, ft, ... - _____ (uncovered tanks only)	Length, ft $L = \frac{SA}{WI} =$ _____	
Less depth allowance for accumulated solids, ft - _____ (0.5 ft. minimum)	23. Circular tank dimensions	
Less depth for freeboard (0.5 ft. recommended), ft - _____	Total height, ft H = _____	
Effective depth, ft (EH) = _____	Diameter, ft $DIA = (1.273 \times SA)^{0.5} =$ _____	
21. Surface area required, $ft^2$ $SA = \frac{WV}{EH} =$ _____	Notes for waste storage tank structure:	
	1. Final dimensions may be rounded up to whole numbers or to use increments on standard drawings.	
	2. Trial and error may be required to establish appropriate dimensions.	

**(2) Picket dams**

Scraped manure that has considerable bedding added can be stored as a solid or semisolid in a picket dam (also known as a picket fence) structure. However, precipitation can accumulate in the storage area if the manure is stored uncovered. The picket dam can also be used to drain runoff from the storage area while retaining the solid manure and bedding within the storage area. Any water drained should be channeled to a storage pond. The amount of water that drains from the manure depends on the amount of precipitation and the amount of bedding in the manure. Water will not drain from manure once the manure and water are thoroughly mixed. Picket dams will not dewater liquid manure; bedding is essential to create void spaces for drainage within the manure.

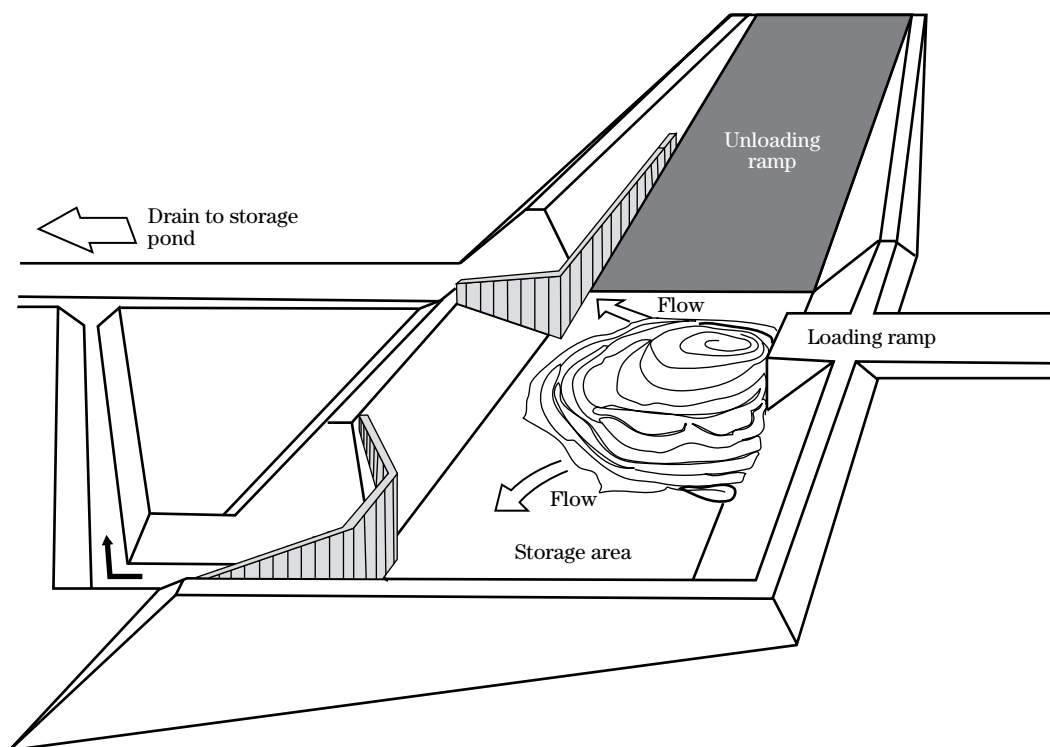
The picket dam should be near the unloading ramp to collect runoff and keep the access as dry as possible. It should also be on the side of the storage area opposite the loading ramp. Water should always have a clear drainage path from the face (leading edge) of the manure pile to the picket dam.

The floor of the storage area using a picket dam should have a slope of no more than 2 percent toward the dam. Picket dams should be made of pressure-treated timbers that have corrosion-resistant fasteners. The openings in the dam should be about 0.75-inch-wide vertical slots. Figure 10–17 shows different aspects of picket dam design.

**(3) Weeping walls**

Flushed manure that contains significant amounts of bedding and sand can also be stored as a solid or semisolid in a weeping wall structure. A long, narrow structure with one long, perforated wall allows sand to settle at the inlet end while solids tend to settle toward the opposite end. The perforated wall (15–30% openings) allows the liquids to drain into a channel and be transferred for storage. Typically, these structures have concrete bottoms and access ramps or removable walls for solids removal. Gravity dewateres the manure and differential settling removes 60 to 70 percent of the sand. However, plugged perforations can be a significant operation and maintenance challenge.

**Figure 10–17** Solid manure storage with picket dam



## (b) Liquid and slurry manure storage

Liquid and slurry manure can be stored in storage ponds or in aboveground or belowground tanks. Solids separation of manure and bedding is a problem that must be considered in planning and design. Solids generally can be resuspended with agitation before unloading, but this involves a cost in time, labor, and energy. Another option allows solids to accumulate if the bottom is occasionally cleaned. This requires a paved working surface for equipment.

Earthen storage is frequently the least expensive type of storage; however, certain restrictions, such as limited space availability, high precipitation, water table, permeable soils, or shallow bedrock, can limit the types of storage considered. Table 10-4 provides guidance on siting, investigation, and design considerations. Storage ponds are earthen basins designed to store manure and runoff (figs. 10-18, 10-19, and 10-20). They generally are rectangular, but may be circular or any other shape that is practical for operation and maintenance. The inside slopes range from 1.5 to 1 (horizontal to vertical) to 3 to 1. The combined slopes (inside plus outside) should not be less than 5 to 1 for embankments. The soil, safety, and operation and maintenance need to be considered in designing the slopes. The minimum top width of embankments shall be in accordance with NRCS Conservation Practice Standard 313, Waste Storage Facility; however, greater widths should be provided for operation of tractors, spreaders, and portable pumps.

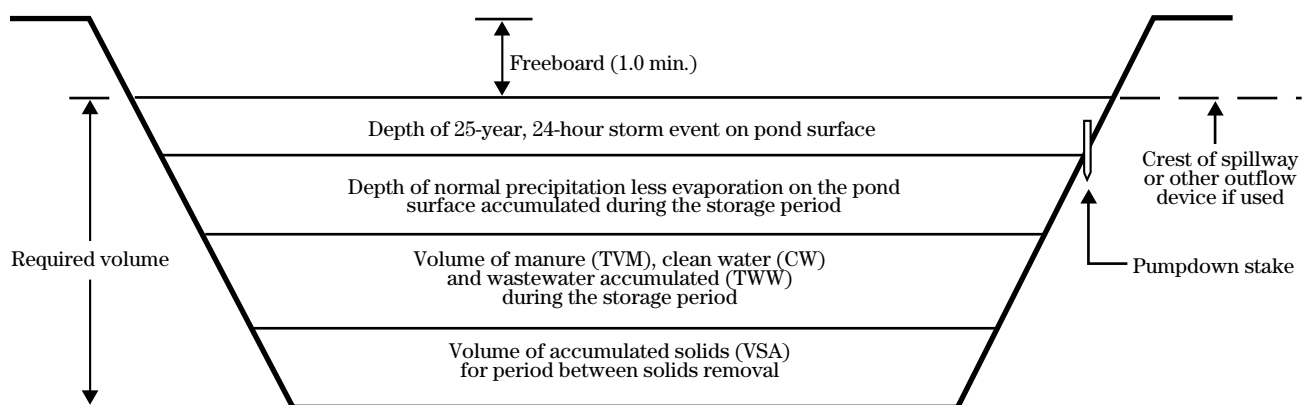
Storage ponds should provide capacity for normal precipitation and runoff (less evaporation) during the storage period. Appendix 10C provides a method for determining runoff and evaporation volumes. A minimum of 1 foot of freeboard is provided.

Inlets to storage ponds can be of any permanent material designed to resist erosion, plugging, or, if freezing is a problem, damage by ice. Typical loading methods are pipes and ramps, which are described in AWMFH 651.1003. Flow of material away from the inlet should be considered in selecting the location of the inlet.

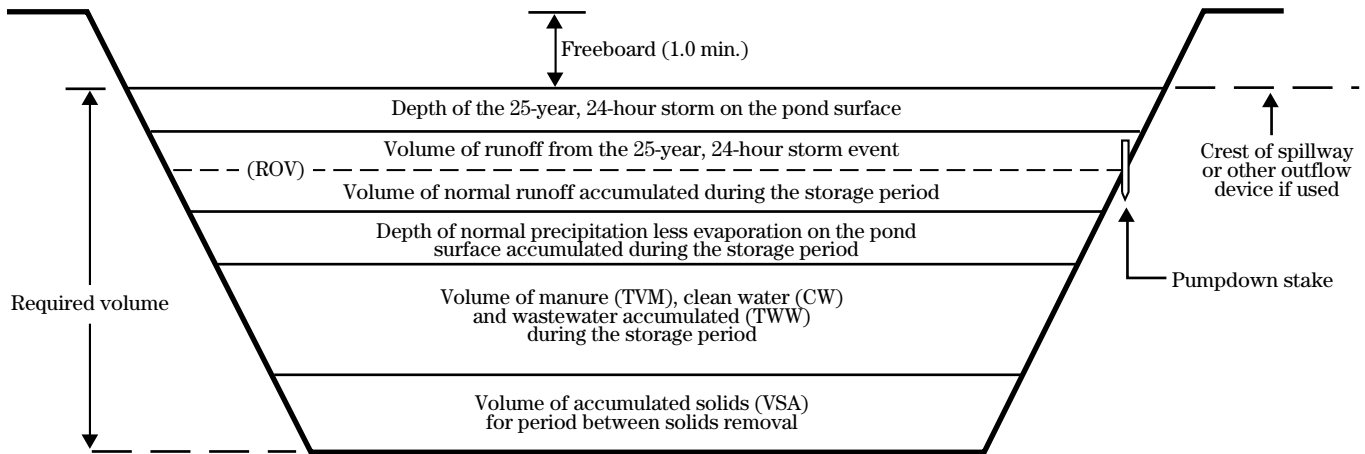
Gravity pipes, pumping platforms, and ramps are used to unload storage ponds. A method for removing solids should be designed for the storage pond. If the contents of the pond will be pumped, adequate access must be provided to thoroughly agitate the material. A ramp should have a slope of 8 to 1 or flatter and be wide enough to provide maneuvering room for unloading equipment.

Pond liners are used in many cases to compensate for site conditions or improve operation of the pond. Concrete, geomembrane, and clay linings reduce permeability and can make an otherwise unsuitable site acceptable. Table 10-4 provides criteria on selection between types of liners. See Appendix 10D, Geotechnical Design and Construction Guidelines for earthen liner information. Also, see Appendix 10E, Synthetic Liner Guidelines for nonearthen liner information.

**Figure 10-18** Cross section of waste storage pond without a watershed

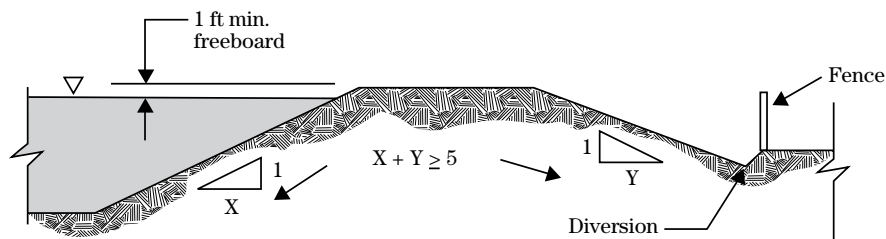
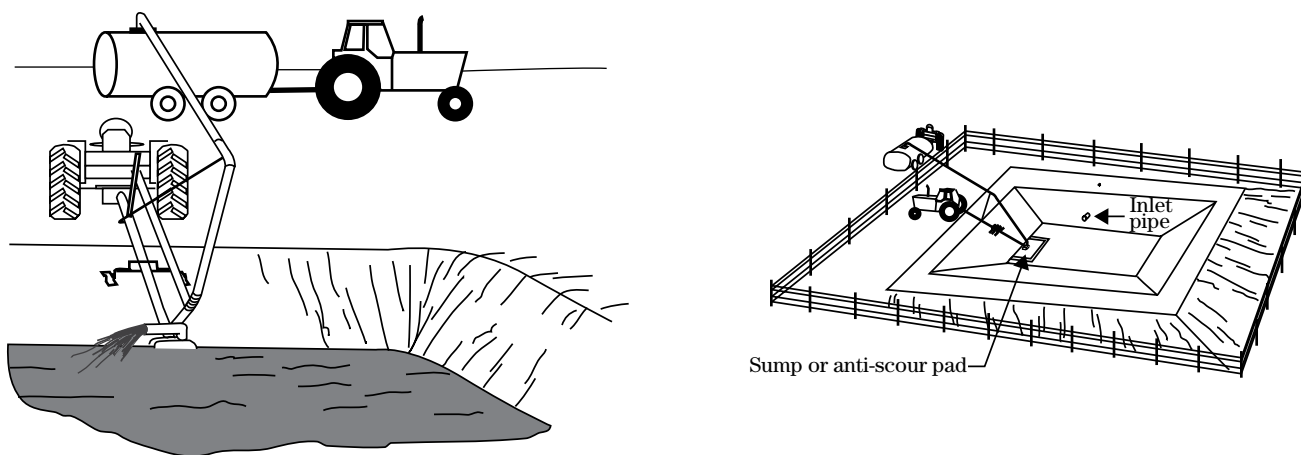


**Figure 10-19** Cross section of waste storage pond with watershed



\*or other outflow device

**Figure 10-20** Waste storage ponds



**Cross-section  
earth embankment**

**Table 10-4** Criteria for siting, investigation, and design of liquid manure storage facilities

<p><b>Risk</b>→</p> <p>↓</p> <p><b>Vulnerability</b></p>	<p><b>Very high</b> &lt;1,500 ft from public drinking water supply wells; <b>OR</b> &lt;100 ft from any domestic well or Class 1 stream</p>	<p><b>High</b> Does not meet Very High Risk criteria; <b>AND</b> Recharge areas for Sole Source aquifers; <b>OR</b> 100 to 600 ft from unconfined domestic water supply well (or where degree of aquifer confinement is unknown) or Class 1 stream</p>	<p><b>Moderate</b> Does not meet High Risk criteria; <b>AND</b> 600 to 1,000 ft from unconfined domestic well (or where degree of aquifer confinement is unknown) or Class 1 stream; <b>OR</b> &lt;600 ft from unconfined nondomestic water supply well (or where degree of aquifer confinement is unknown) or Class 2 stream</p>	<p><b>Slight</b> Does not meet Moderate Risk criteria; <b>AND</b> &gt;1,000 ft from unconfined domestic well (or where degree of aquifer confinement is unknown) or Class 1 stream; <b>AND</b> &gt;600 ft from unconfined nondomestic water supply well (or where degree of aquifer confinement is unknown) or Class 2 stream</p>
<p><b>Very high</b> Large voids (e.g., karst, lava tubes, mine shafts); <b>OR</b> Highest anticipated ground water elevation within 5 ft of invert; <b>OR</b> &lt;600 ft from improperly abandoned well*</p> <p><b>High</b> Does not meet Very High Vulnerability criteria: <b>AND</b> Bedrock (assumed fractured) within 2 ft of invert; <b>OR</b> Coarse soils/parent material (Permeability Group I soils as defined in AWMFH, always including GP, GW, SP, SW); <b>OR</b> Highest anticipated groundwater elevation is between 5 to 20 ft below invert; <b>OR</b> 600 to 1,000 ft from improperly abandoned well*</p>	<p><b>Evaluate other storage alternatives</b> * (or properly seal well and reevaluate vulnerability)</p>	<p><b>Evaluate other storage alternatives</b> * (or properly seal well and reevaluate vulnerability)</p>		
<p><b>Moderate</b> Does not meet High Vulnerability criteria; <b>AND</b> Medium soils/parent material (Permeability Group II soils as defined in AWMFH, usually including CL-ML, GM, SM, ML); <b>OR</b> Flocculated or blocky clays (typically associated with high Ca); <b>OR</b> Complex stratigraphy (discontinuous layering); <b>OR</b> Highest anticipated ground water elevation is between 21 to 50 ft below invert; <b>OR</b> 600-1,000 ft from improperly abandoned well*</p>		<p><b>Evaluate other alternatives or synthetic liner as allowed</b></p> <p>Local regulations may apply</p> <p>Consult with area engineer</p>	<p><b>Synthetic liner required</b> * (or properly seal well and reevaluate vulnerability) No additional site characterization required</p>	<p><b>Liner required</b> * (or properly seal well and reevaluate vulnerability) Specific discharge <math>\leq 1 \times 10^{-6} \text{ cm}^3/\text{cm}^2/\text{s}</math> No manure sealing credit Earthen liner design includes sampling and testing of liner material (Classification, Standard Proctor compaction, Permeability)</p>
<p><b>Low</b> Does not meet Moderate Vulnerability criteria; <b>AND</b> Fine soils/parent material (Permeability Group III and IV soils as defined in AWMFH, usually including GC, SC, MH, CL, CH); <b>AND</b> Highest anticipated ground water elevation is &gt;50 ft below invert</p>			<p><b>Further evaluate need for liner</b> Specific discharge <math>\leq 1 \times 10^{-6} \text{ cm}^3/\text{m}^2/\text{s}</math> No manure sealing credit Earthen liner/no liner design includes sampling and testing of liner/in-place material (Classification, Standard Proctor compaction/in-place density, Remolded/Undisturbed sample Permeability)</p>	<p><b>Further evaluate need for liner</b> Specific discharge <math>\leq 1 \times 10^{-6} \text{ cm}^3/\text{cm}^2/\text{s}</math> No manure sealing credit Earthen liner/no liner design includes sampling and testing of liner/in-place material (Classification, Standard Proctor compaction/ in-place density, Remolded/Undisturbed sample Permeability)</p>
		<p><b>Further evaluate need for liner</b> Specific discharge <math>\leq 1 \times 10^{-6} \text{ cm}^3/\text{cm}^2/\text{s}</math> No manure sealing credit Earthen liner/no liner design includes sampling and testing of liner/ in-place material (Classification, Standard Proctor compaction/ in-place density, Remolded/Undisturbed sample Permeability) Scarify and recompact surface to seal cracks and break down soil structure as appropriate</p>	<p><b>Liner not required</b> Specific discharge <math>\leq 1 \times 10^{-6} \text{ cm}^3/\text{cm}^2/\text{s}</math> Field classification and published permeability data may be used Construction method specifications may be used Scarify and recompact surface to seal cracks and break down soil structure as appropriate</p>	

\*See local regulations

Concrete can be used to provide a wear surface if unloading equipment will enter the pond.

Figures 10–21, 10–22, and 10–23 represent various kinds of storage ponds and tanks.

Liquid manure can be stored in aboveground (fig. 10–22) or belowground (fig. 10–23) tanks. Liquid manure storage tanks are usually composed of concrete or glass-lined steel. Belowground tanks can be loaded using slatted floors, push-off ramps, gravity pipes or gutters, or pumps. Aboveground tanks are typically loaded by a pump moving the manure from a reception pit. Tank loading can be from the top or bottom of the tank depending on such factors as desired agitation, minimized pumping head, weather conditions, and system management.

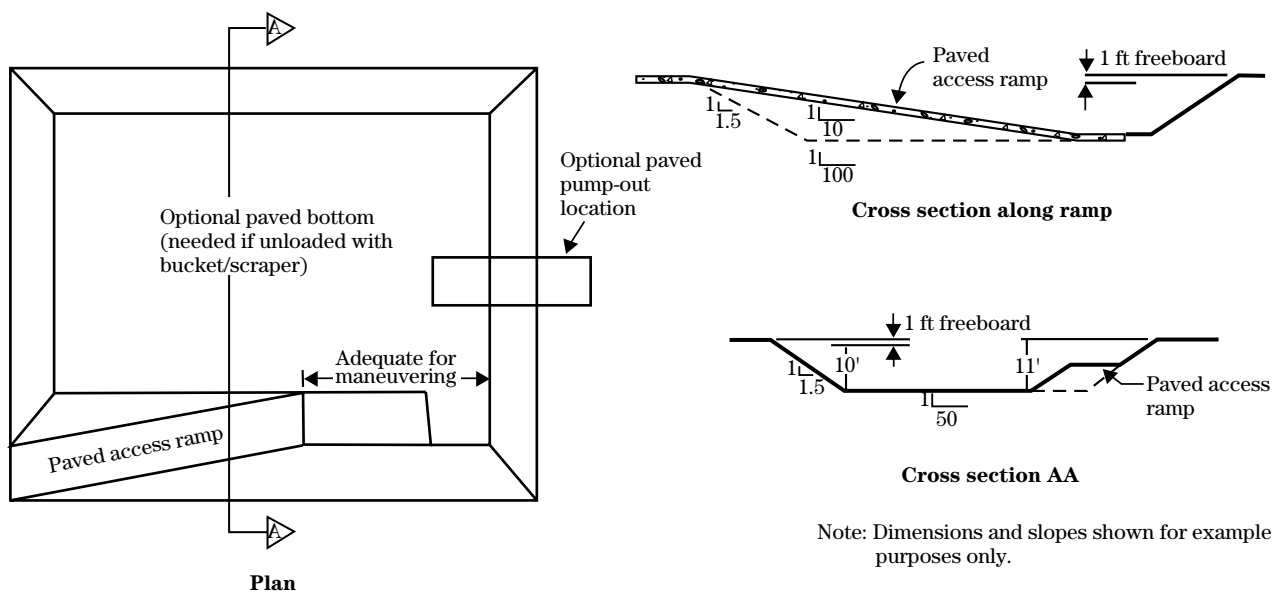
Storage volume requirements for tanks are the same as those for ponds except that provisions are normally made to exclude outside runoff from storage tanks because of the relative high cost of storage. Of course, if plans include storage of outside runoff, accommodation for its storage must be included in the tank's volume.

Tanks located beneath slatted floors can sometimes be used for temporary storage with subsequent discharge into lagoons or other storage facilities. Recycled lagoon effluent is added to a depth of 6 to 12 inches in underslat pits to reduce tendency for manure solids to stick to the pit floor. Manure and bedding are allowed to collect for several days, typically 1 to 2 weeks, before the pits are gravity drained.

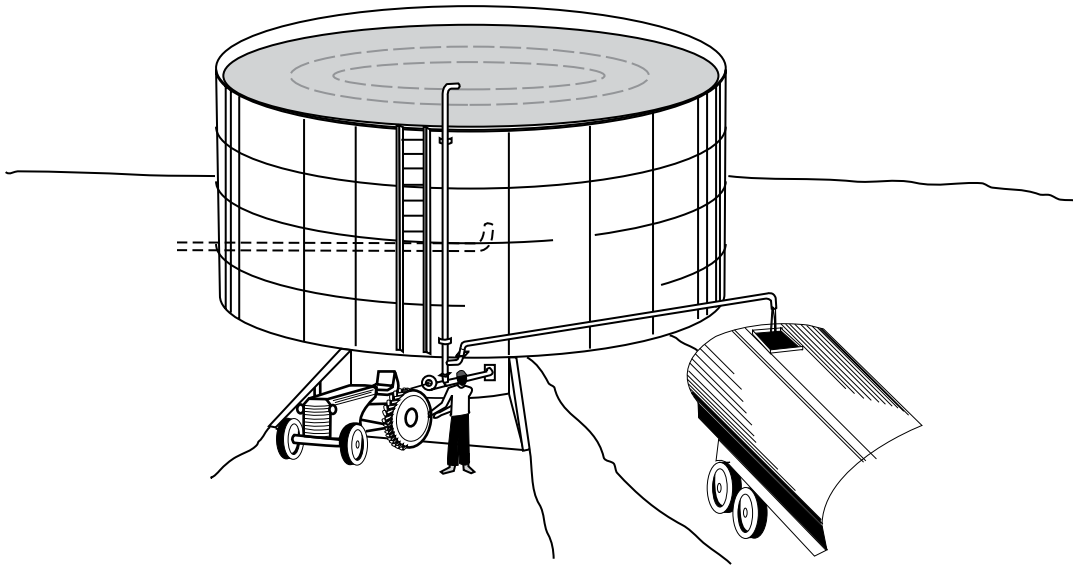
### (1) Design considerations

*Tank material types*—the primary materials used to construct manure tanks are reinforced concrete and glass-lined steel. Such tanks must be designed by a professional engineer and constructed by experienced contractors. A variety of manufactured, modular, and cast-in-place tanks are available from commercial suppliers. NRCS concurs in the standard detail drawings for these structures based on a review and approval of the drawings and supporting design calculations. A determination must be made that the site conditions are compatible with the design assumptions on which the design is based. Structures can also be designed on an individual site-specific basis.

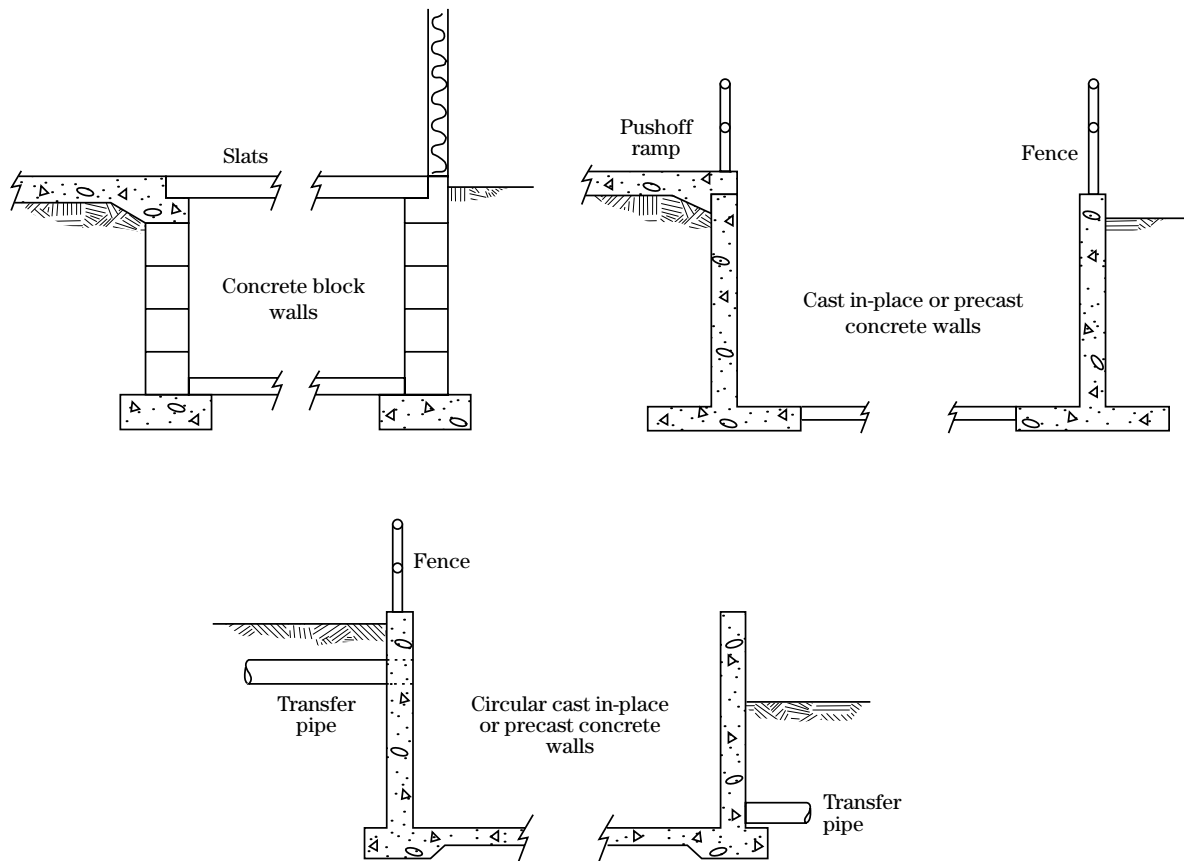
**Figure 10–21** Layout of waste storage ponds



**Figure 10-22** Aboveground waste storage tank



**Figure 10-23** Belowground waste storage structure



Cast-in-place, reinforced concrete, the principal material used in belowground tanks, can be used in aboveground tanks, as well. Tanks can also be constructed of precast concrete panels that are bolted together. Circular tank panels are held in place with metal hoops. The panels are positioned on a concrete foundation or have footings cast as an integral part of the panel. Tank floors are cast in-place slabs.

Other aboveground tanks are constructed of metal. Glass-fused steel panels are widely used. Such tanks are manufactured commercially and must be constructed by trained crews. Other kinds of metal panels are also used.

*Sizing*—storage ponds and structures should be sized to hold all of the manure, bedding, washwater from the milkhouse; flushing; and contaminated runoff that can be expected during the storage period. Equation 10-3 can be used to compute the waste volume:

$$WV = TVM + TWM + TBV \quad (\text{eq. 10-3})$$

where:

WV = waste volume for storage period, ft<sup>3</sup>

TVM = total volume of manure for storage period, ft<sup>3</sup>  
(see eq. 10-1)

TWM = total wastewater volume for storage period,  
ft<sup>3</sup>

TBV = total bedding volume for storage period, ft<sup>3</sup>  
(see eq. 10-2)

Data on manure production are available in AWMFH, chapter 4 or from the farmer or rancher. Appendix 10C provides a method of estimating contaminated runoff volume.

In addition to the waste volume, storage tanks must, if uncovered, provide a depth to accommodate precipitation less evaporation on the storage surface during the most critical storage period. The most critical storage period is generally the consecutive months that represent the storage period that gives the greatest depth of precipitation less evaporation. Appendix 10C gives a method for estimating precipitation less evaporation. Storage tanks must also provide a depth of 0.5 feet for material not removed during emptying. A depth for freeboard of 0.5 feet is also recommended.

Storage ponds must also provide a depth to accommodate precipitation less evaporation during the most

critical storage period. If the pond does not have a watershed, the depth of the 25-year, 24-hour precipitation on the pond surface must be included. Appendix 10B includes a map giving the precipitation amount for the 25-year, 24-hour precipitation. Frequently, storage ponds are designed to include outside runoff from watersheds. For these, the runoff volume of the 25-year, 24-hour storm must be included in the storage volume.

Appendix 10C gives a procedure for estimating the runoff volume from feedlots. The NRCS NEH 650, Engineering Field Handbook, chapter 2, or by some other hydrologic method may be used to estimate runoff volumes for other watershed areas.

## (2) Design of sidewalls and floors

The information on the design of sidewalls and floors on solid manure storage material in AWMFH 651.1004(a) is applicable to these items used for liquid manure storage. All possible influences, such as internal and external hydrostatic pressure, flotation and drainage, live loads from equipment and animals, and dead loads from covers and supports, must be considered in the design.

*Pond sealing*—storage ponds must not allow excess seepage. The soil in which the pond is to be located must be evaluated and, if needed, tested during planning and design to determine need for an appropriate liner. Refer to AWMFH 651.07 for more detailed information on determining the need for and design of liners.



**Design example 10–3      Storage tank**

Mr. Bill Walton of Middlesburg, Tennessee, has requested assistance on a manure management system. The selected alternative includes a below-ground, covered, slurry storage tank for his Holstein dairy herd. He has 75 heifers that are about 1,000 pounds each and 150 milkers (average milk production of 75 lb/d) that average 1,400 pounds. Bedding material is not used with these animals. Based on crop utilization of the nutrients, storage is needed for 75 days. The critical storage periods are January 1 to March 15 and July 1 to September 15. The wash-water from the milking house and parlor is also stored. No runoff will be directed to the storage. Worksheet 10A–1 shows how to determine the necessary volume for the storage tank and several possible sets of tank dimensions. It also shows how to estimate the total solids content of the stored material.

*Manure production*—the animal type, average weight, and number are entered on lines 1, 2, and 3. The equivalent 1,000-pound animal unit (AU) for the animal type is calculated and entered on line 4. The daily volume of manure (DVM) production for each animal type is selected from table 4–5(b) and entered on line 5. The storage period (D) is entered on line 6. The total manure volume (VMD) is calculated for each animal type and entered on line 7. Add the VMD for each animal type and enter the sum (TVM) on line 8.

*Wastewater volume*—the daily milking center wastewater volume per animal unit description (DWW) is selected from table 4–7 of AWMFH, chapter 4, and entered on line 9. The wastewater volume for the animal type for the storage period (WWD) is

calculated and entered on line 10. Add the wastewater volumes for each animal type and enter the sum (TWW) on line 11.

*Bedding volume*—bedding is not used in this example. If bedding were used, however, its volume for the storage period would be determined using lines 12 through 15.

*Waste volume*—WV is the total volume of waste material that will be stored including total manure (TVM), total wastewater (TWW), and total bedding volume (TBV). Provisions are to be made to assure that outside runoff does not enter the tank. In addition, if the tank is not covered, the depth of precipitation less evaporation on the tank surface expected during the most critical storage period must be added to the depth requirements.

*Total depth available*—the desired depth is the total planned depth based on such considerations as foundation condition, tank wall design, and standard drawing depth available.

*Surface area*—the surface area (SA) (line 21) dimensions are calculated using the equation for SA.

*Tank dimensions*—because tanks are rectangular or circular, various combinations of length and width can be used to provide the SA required. If the depth is held constant, only one solution for the diameter of a circular tank is possible. The dimensions of either shape can be rounded upward to match a standard detail drawing or for convenience.

**Worksheet 10A-1—Waste storage structure capacity design**

Decisionmaker: <u>Bill Walton</u>		Date: <u>6/13/87</u>	
Site: <u>Middlesburg, TN</u>			
<b>Animal units</b>			
1. Animal type <u>Milkers</u> <u>Heifers</u>	3. Number of animals (N)..... <u>150</u> <u>75</u>		
2. Animal weight, lbs (W) <u>1,400</u> <u>1,000</u>	4. Animal units, $AU = \frac{W \times N}{1000}$ = <u>210</u> <u>75</u>		
<b>Manure volume</b>			
5. Daily volume of daily manure production per AU, ft <sup>3</sup> /AU/day (DVM)= <u>1.7</u> <u>0.9</u>	7. Total volume of manure production for animal type for storage period, ft <sup>3</sup> VMD = AU x DVM x D = <u>26,775</u> <u>5,063</u>		
6. Storage period, days (D) = <u>75</u>	8. Total manure production for storage period, ft <sup>3</sup> (TVM)..... <u>31,838</u>		
<b>Wastewater volume</b>			
9. Daily wastewater volume per AU, ft <sup>3</sup> /AU/day (DWW) = <u>0.6</u> <u>0</u>	11. Total wastewater volume for storage period, ft <sup>3</sup> (TWW) ..... <u>9,450</u>		
10. Total wastewater volume for animal description for storage period, ft <sup>3</sup> WWD = DWW x AU x D = <u>9,450</u> <u>0</u>			
<b>Bedding volume</b>			
12. Amount of bedding used daily for animal type, lbs/AU/day (WB) = _____	14. Bedding volume for animal type for storage period, ft <sup>3</sup> = _____		
13. Bedding unit weight, lbs/lb <sup>3</sup> (BUW) = _____	$VBD = \frac{0.5 \times WB \times AU \times D}{BUW}$		
	15. Total bedding volume for storage period, ft <sup>3</sup> (TBV) = _____ <u>0</u>		
<b>Minimum waste storage volume requirement</b>			
16. Waste storage volume, ft <sup>3</sup> (WV) = TVM + TWW + TBV = <u>31,838</u> + <u>9,450</u> + <u>0</u> = <u>41,288</u>			
<b>Waste stacking structure sizing</b>			
17. Structure length, ft $L = \frac{WV}{WI \times H}$ = _____	19. Structure height, ft $H = \frac{WV}{L \times WI}$ = _____		
18. Structure width, ft $WI = \frac{WV}{L \times H}$ = _____			
Notes for waste stacking structure:			
1. The volume determined (WSV) does not include any volume for freeboard. It is recommended that a minimum of 1 foot of freeboard be provided for a waste stacking structure.		2. The equations for L, WI, and H assume manure is stacked to average height equal to the sidewall height. Available storage volume must be adjusted to account for these types of variations.	
<b>Tank sizing</b>			
20. Effective depth, ft. (EH)	22. Rectangular tank dimensions		
Total height (or depth) of tank desired, ft (H)..... <u>12</u>	Total height, ft (H) = <u>12</u>	Selected width, ft (WI) = <u>28</u>	
Less precipitation for storage period, ft. --- <u>0</u> (uncovered tanks only)	Length, ft $L = \frac{SA}{WI}$ = <u>134</u> (USE 136)		
Less depth allowance for accumulated solids, ft - <u>0.5</u> (0.5 ft. minimum)	23. Circular tank dimensions		
Less depth for freeboard (0.5 ft. recommended), ft - <u>0.5</u>	Total height, ft H = <u>12</u>		
Effective depth, ft (EH) = _____ <u>11</u>	Diameter, ft $DIA = (1.273 \times SA)^{0.5}$ = <u>69.1</u> (USE 70)		
21. Surface area required, ft <sup>2</sup> $SA = \frac{WV}{EH}$ = <u>3,753</u>	Notes for waste storage tank structure:		
	1. Final dimensions may be rounded up to whole numbers or to use increments on standard drawings.		
	2. Trial and error may be required to establish appropriate dimensions.		

**Design example 10–4    Storage pond**

Mr. Joe Green of Silverton, Oregon, has requested assistance in developing a manure management system for his dairy. He has selected an alternative that includes a storage pond component. He has a Holstein herd composed of 500 milkers weighing 1,400 pounds with an average milk production of 75 pounds per day, 150 dry cows averaging 1,400 pounds; and 150 heifers averaging 1,000 pounds. He has a freestall barn that has flush alleys. He uses foam pads for bedding. The alternative selected includes land application. A storage period of 180 days is required for storage through the winter months of high precipitation. A solid separator will be used to minimize solid accumulation in the storage pond and to allow recycling of the flushwater. Water from the milkhouse and parlor will be stored in the pond. Use worksheet 10A-2 to determine the required capacity and size of the pond.

*Manure production*—the animal type, average weight, and numbers are entered on lines 1, 2, and 3. The number of 1,000-pound animal unit (AU) for each animal type is calculated and entered on line 4. The volume of daily manure production (DVM) from table 4–5(b) in AWMFH, chapter 4, is entered on line 5. The storage period (D) is entered on line 6. The manure volume for the storage period for each animal type (VMD) is then calculated and entered on line 7. The total volume (TVM) is added and then entered on line 8.

*Wastewater volume*—in this example, only the wastewater from the milkhouse and parlor is accounted for in the waste storage volume requirements because the alley flushwater is recycled. The daily wastewater volume per animal unit (DWW) from table 4-6 in AWMFH, chapter 4, is entered on line 9. The wastewater volume for each animal type for the storage period (WWD) is calculated using the equation and entered on line 10. The wastewater volume from each animal

type (WWD) is added, and the sum (TWW) is entered on line 11.

*Clean water volume*—in this example, no clean water is added. However, if clean water (CW) is added for dilution, for example, the amount added during the storage period would be entered on line 12.

*Runoff volume*—for this example, the storage pond does not have a watershed and storage for runoff is not needed. However, storage ponds are frequently planned to include the runoff from a watershed, such as a feedlot. The ponds that have a watershed must include the normal runoff for the storage period and the runoff volume for the 25-year, 24-hour storm. The runoff volume from feedlots may be calculated using the procedures in appendix 10C. For watersheds or parts of watersheds that have cover other than feedlots, the runoff volume may be determined using the procedure in chapter 2 of the NEH 651, Engineering Field Handbook. The value for watershed runoff volume (ROV) is entered on line 13. Documentation showing the procedure and values used in determining the volume of runoff should be attached to the worksheet.

*Volume of accumulated solids*—this volume is to accommodate the storage of accumulated solids for the period between solids removal. The solids referred to are those that remain after the liquid has been removed. An allowance for accumulated solids is required mainly for ponds used to store wastewater and polluted runoff. Solids separation, agitation before emptying, and length of time between solids removal all affect the amount of storage that must be provided. Enter the value for accumulated solids (VSA) on line 14. In this example, the solids from the manure are separated and solids accumulation will be minimal. No storage is provided for accumulated solids. (*Continued*)

**Design example 10–4      Storage pond—Continued**

*Waste volume*—the total waste storage volume (WV) is determined by adding the total volume of manure (TVM), total wastewater volume (TWW), clean water added (CW), and volume allowance for solids accumulation (VSA). Storage ponds that have a watershed must also include the normal runoff volume for the storage period and the volume of the 25-year, 24-hour storm runoff (ROV). WSV is calculated on line 15. The storage pond must be sized to store this volume plus additional depth as explained in “depth adjustment.”

*Storage pond sizing*—the storage pond is sized by trial and error for either a rectangular or circular shaped pond by using the procedure on **line 16**.

*Depth adjustment*—the depth required for the storage volume with the selected pond dimensions must be adjusted by adding depth for the precipitation less evaporation and the depth of the 25-year, 24-hour storm on the pond surface. The minimum freeboard is 1 foot. The adjustment for final depth is made using line 17.

**Completed worksheet for Design example 10-4**

Worksheet 10A-2—Waste storage pond design			
Decisionmaker: <u>Joe Green</u>		Date: <u>10/4/90</u>	
Site: <u>Silverton, OR</u>			
<b>Animal units</b>			
1. Animal type	<u>Milkers</u> <u>Dry</u> <u>Heifers</u>	3. Number of animals (N)	<u>500</u> <u>150</u> <u>150</u>
2. Animal weight, lbs (W)	<u>1,400</u> <u>1,400</u> <u>1,000</u>	4. Animal units, $AU = \frac{W \times N}{1000}$	= <u>700</u> <u>210</u> <u>150</u>
<b>Manure volume</b>			
5. Daily volume of manure production per AU, ft <sup>3</sup> /AU/day (DVM)	= <u>1.7</u> <u>0.84</u> <u>0.9</u>	7. Total volume of manure production for animal type for storage period, ft <sup>3</sup>	<u>214,200</u> <u>31,752</u> <u>24,300</u>
6. Storage period, days (D)	= <u>180</u>	VMD = AU x DVM x D =	=
		8. Total manure production for storage period, ft <sup>3</sup> (TVM)	<u>270,252</u>
<b>Wastewater volume</b>			
9. Daily wastewater volume per AU, ft <sup>3</sup> /AU/day (DWW)	= <u>0.6</u> <u>0</u> <u>0</u>	11. Total wastewater volume for storage period, ft <sup>3</sup> (TWW)	<u>75,600</u>
10. Total wastewater volume for animal description for storage period, ft <sup>3</sup>	WWD = DWW x AU x D = <u>75,600</u>		
<b>Clean water volume</b>		<b>Runoff Volume</b>	
12. Clean water added during storage period, ft <sup>3</sup> (CW)	<u>0</u>	13. Runoff volume, ft <sup>3</sup> (ROV) (attach documentation)	<u>0</u>
<b>Solids accumulation</b>		Includes the volume of runoff from the drainage area due to normal runoff for the storage period and the runoff volume from the 25-year, 24-hour storm.	
14. Volume of solids accumulation, ft <sup>3</sup> (VSA)	<u>0</u>		
<b>Waste volume requirement</b>			
15. Waste volume, ft <sup>3</sup>	(WV) = TVM + TWW + CW + ROV + VSA		
	= <u>270,252</u> + <u>75,600</u> + <u>0</u> + <u>0</u> + <u>0</u> = <u>345,852</u>		
<b>Pond sizing</b>			
16. Sizing by trial and error			
Side slope ratio, (Z) = <u>3</u> V must be equal to or greater than WV = <u>345,852</u> ft <sup>3</sup>			
Rectangular pond,		Circular pond,	
$V = \left( \frac{4 \times Z^2 \times d^3}{3} \right) + (Z \times BL \times d^2) + (Z \times BW \times d^2) + (BW \times BL \times d)$		$V = (1.05 \times Z^2 \times d^3) + (1.57 \times W \times Z \times d^2) + (0.79 \times W^2 \times d)$	
Trial no.	Bottom width ft (BW)	Bottom length ft (BL)	Depth* ft (d)
1	<u>100</u>	<u>500</u>	<u>6</u>
2	<u>100</u>	<u>450</u>	<u>6</u>
3	<u>100</u>	<u>450</u>	<u>6.2</u>
4	<u>100</u>	<u>455</u>	<u>6.2</u>
			Volume ft <sup>3</sup> (V)
			<u>367,392</u>
			<u>331,992</u>
			<u>345,286</u>
			<u>348,963</u>
			≈ <u>WSV OK</u>
* Depth must be adjusted in Step 17.			
<b>Depth adjustment</b>			
17. Depth adjustment			
Depth, ft (d) <u>6.2</u>			
Add depth of precipitation less evaporation (For the storage period)		+ <u>2.3</u>	
Add depth of 25-year, 24-hour storm		+ <u>0.3</u>	
Final depth		+ <u>1.0</u>	
		<u>9.8</u>	

## 651.1005 Treatment

In many situations, manure treatment is necessary before final utilization. Adequate treatment reduces pollution potential of the manure through biological, physical, and chemical processes using such components as lagoons, oxidation ditches, composting, and constructed wetlands. These types of components reduce nutrients, reduce pathogen counts, and reduce total solids. Composting also reduces the volume of the material. Treatment may also include solids separation, drying, and dilution that prepare the material for facilitating another function. By their nature, treatment facilities require a higher level of management than that of storage facilities.

### (a) Primary treatment

Primary treatment includes the physical processes such as solids-liquids separation, moisture adjustment, and dilution. Although not required, primary treatment is often followed by secondary treatment prior to storage or land application.

#### (1) Drying/dewatering

If the water is removed from freshly excreted manure, the volume to handle can be reduced. The process of removing water is referred to as dewatering. In the arid regions of the United States, most manure is dewatered (dried) by evaporation from sun and wind. Some nutrients may be lost in the drying process.

Dried or dewatered manure solids are often sold as a soil conditioner or garden fertilizer. These solids may also be used as fertilizer on agricultural land. They are high in organic matter and can be expected to produce odors if moisture is added and the material is not re-dried or composted. Because the water is removed, the concentrations of some nutrients and salts will change. Dried manure should be analyzed to determine the nutrient concentrations before land application.

In humid climates, dewatering is accomplished by adding energy to drive off the desired amount of moisture. Processes have been developed for drying manure in greenhouse-type facilities; however, the drying rate is dependent on the temperature and relative humidity.

The cost of energy often makes the drying process unattractive.

#### (2) Solid/liquid separation

Animal manure contains material that can often be reclaimed. Solids in dairy manure from animals fed a high roughage diet can be removed and processed for use as good quality bedding. Some form of separation must be used to recover these solids. A mechanical separator or settling basin is typically employed. Separators are also used to reduce solids content and required storage volumes.

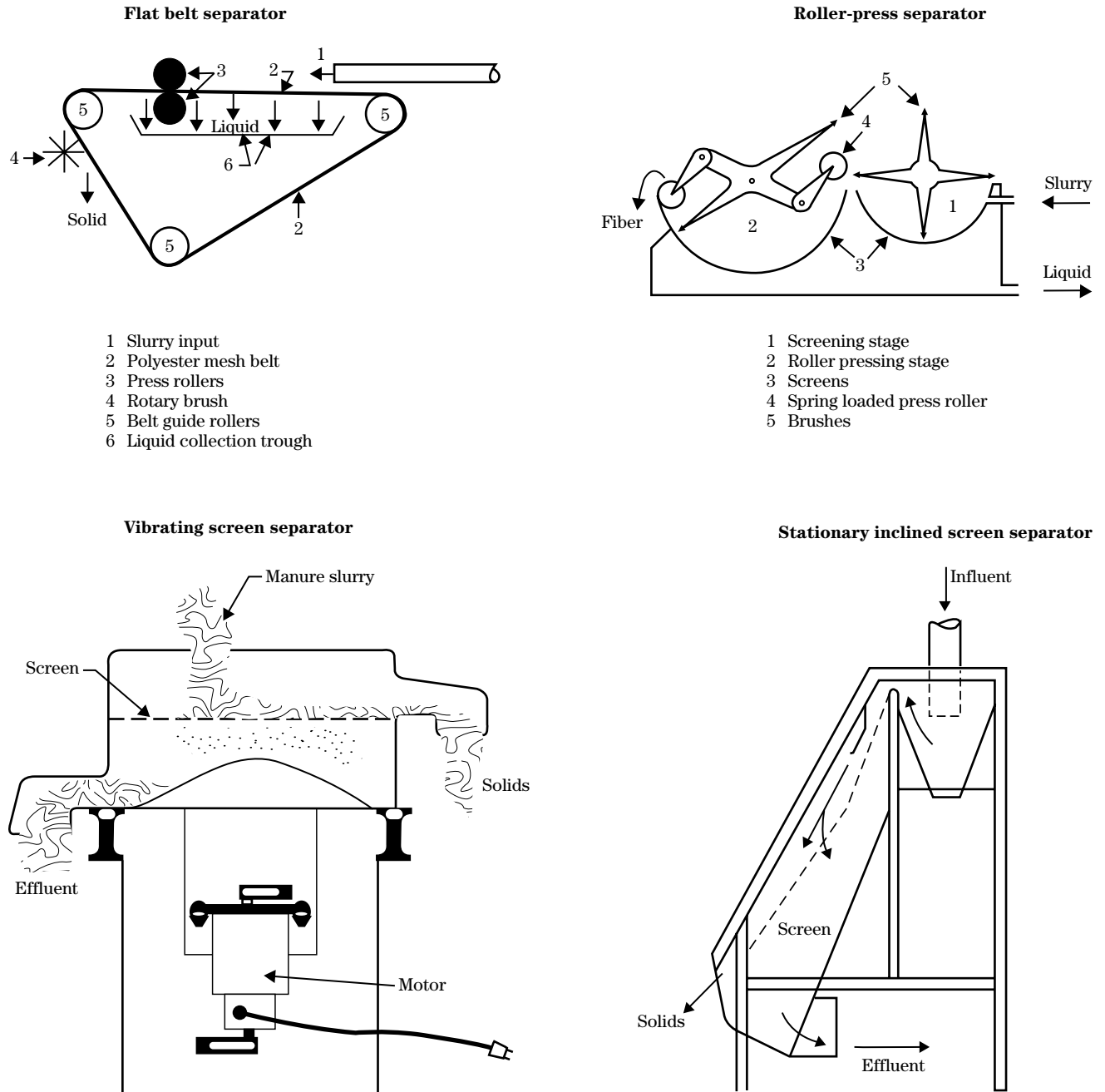
Separators also facilitate handling of manure. For example, solid separation can allow the use of conventional irrigation equipment for land application of the liquids. Separation eliminates many of the problems associated with the introduction of solids into storage ponds and treatment lagoons by reducing solids accumulation and minimizing agitation requirements. Separation facilities should be planned and designed in accordance with NRCS Conservation Practice Standard 632, Solid/Liquid Waste Separation Facility.

**Mechanical separation**—Several kinds of mechanical separators can be used to remove by-products from manure (fig. 10–24). One kind commonly used is a screen. Screens are statically inclined or in continuous motion to aid in separation. The most common type of continuous motion screen is a vibrating screen. The TS concentration of manure to be processed by a screen should be reduced to less than 5 percent. Higher TS concentrations reduce the effectiveness of the separator.

A centrifuge separator uses centrifugal force to remove the solids, which are eliminated from the machine at a different point than the liquids. In addition, various types of presses can be used to force the liquid part of the manure from the solid part.

Several design factors should be considered when selecting a mechanical separator. One factor is the amount of liquid manure that the machine can process in a given amount of time. This is referred to as the “throughput” of the unit. Some units have a relatively low throughput and must be operated for a long time. Another very important factor is the TS content required by the given machine. Centrifuges and presses can operate at a higher TS level than can static screens.

**Figure 10-24** Schematic of mechanical solid-liquid separators



Consideration should be given to handling the separated materials. Liquid can be collected in a reception pit and later pumped to storage or treatment. The separated solids will have a TS concentration of 15 to 40 percent. While a substantial amount of nutrients is removed with the solids, the majority of the nutrients and salt remain in the liquid fraction. In many cases, water drains freely from piles of separated solids. This liquid needs to be transferred to storage to reduce odors and fly breeding.

Typically, solids must still be processed before they can be used. If they are intended for bedding, the material should be composted or dried.

A planner/designer needs to know the performance characteristics of the separator being considered for the type of manure to be separated. The best data, if

available, would be that provided by the separator manufacturer. If that data is not available, the manufacturer or supplier may agree to demonstrate the separator with material to be separated. This can also provide insight as to the effectiveness of the equipment.

If specific data on the separator is not available, tables 10-5 and 10-6 can be used to estimate performance characteristics. Table 10-5(a) gives data for separating different materials using different separators, and table 10-6 presents general operational characteristics of mechanical separators.

**Settling basins**—In many situations, removing manure solids, soil, and other material from runoff from livestock operations is beneficial. The most common device to accomplish this is the settling or solids

**Table 10-5** Operational data for solid/liquid separators (a); settling basin performance (b)

(a) Operational data for solid/liquid separators

Animal type	Separator	TS concentration (%)			% Retained in separated solids				
		Raw waste	Separated		TS	VS	COD	N	P
			liquids	solids					
Dairy	Vibrating screen								
	16 mesh	5.8	5.2	12.1	56	—	—	—	—
	24 mesh	1.9	1.5	7.5	70	—	—	—	—
	Decanter centrifuge								
	16-30 gal/min	6-8	4.9-6.5	13-33	35-40	—	—	—	—
	Static inclined screen								
	12 mesh	4.6	1.6	12.2	49	—	—	—	—
	32 mesh	2.8	1.1	6.0	68	—	—	—	—
	Screw press	2-7	1-4	20-30	26-34	—	—	—	—
Beef	Static inclined screen	4.4	3.8	13.3	15	—	—	—	—
	Vibrating screen	1-2	—	—	40-50	—	—	—	—
Swine	Decanter centrifuge								
	3 gal/min	7.6	2.6	37	14	—	—	—	—
	Vibrating screen								
	22 gal/min/ft <sup>2</sup>								
	18 mesh	4.6	3.6	10.6	35	39	39	22	26
	30 mesh	5.4	3.5	9.5	52	56	49	33	34
	Screw press	2-5	—	22-34	16-30	—	—	—	—



separation basin. A settling basin used in association with livestock operations is a shallow basin or pond that is designed for low velocities and the accumulation of settled materials. When the basin is positioned between the source and the storage or treatment facilities, settling will occur if the velocity of the liquid is below 1.5 feet per second.

Settling basins should have access ramps that facilitate removal of settled material. Outlets from settling basins should be located so that sediment removal is

not restricted. Chemical additives are sometimes used to aid differential settling by flocculation. Flocculants are outside the scope of this document. Table 10–5(b) provides settling basin performance, wet basis.

### (3) Dilution

Dilution is often used to facilitate another function. This process involves adding clean water or water that has less total solids to manure, resulting in a mixture that has a desired percentage of total solids. A common use of dilution is to prepare the manure for land

**Table 10–5** Operational data for solid/liquid separators (a); settling basin performance (b)—Continued

(b) Settling basin performance (results in wet basis) (LPES 2001)

Manure	Input solids, %	% removal from liquid				
		Solids	COD	TKN	N-org	TP
Flushed dairy	3.83	55 (VS)	61	—	26	28
Dairy	1.1	65	—	40	—	—
Poultry, beef, dairy, swine, horse	-1	45–76*	28–67*	—	—	—
Feedlot runoff	1–3	40–64	—	84	—	80
Flushed swine	0.2	12	—	33	—	22
Feedlot runoff	1–3	13	—	0.7	—	0.3

\* 10-minute setting time

**Table 10–6** Characteristics of solid/liquid separators (Barker 1986)

Characteristic	Decanter centrifuge (%)	Vibrating screen	Stationary inclined screen
Typical screen opening	—	20 mesh	10–20 mesh
Maximum waste TS concentration	8	5	5
Separated solids TS concentration	to 35	to 15	to 10
TS reduction*	to 45	to 30	to 30
COD reduction*	to 70	to 25	to 45
N reduction*	to 20	to 15	to 30
P reduction*	to 25	—	—
Throughput (gal/min)	to 30	to 300	to 1,000

\* Removed in separated solids

application using a sprinkler system. Figure 10–25 is a design aid for determining the amount of clean dilution water required to lower the TS concentration.

## (b) Secondary treatment

Secondary treatment includes biological and chemical treatment such as composting, lagoons, oxidation ditches, and vegetative treatment areas. This additional treatment step reduces the pollution potential prior to land application by reducing the nutrient contents of the material. Secondary treatment facilities should be planned and designed in accordance with the applicable Conservation Practice Standards.

### (1) Amendments for treatment

Biological and chemical additives are sometimes used to alter the characteristics of manure and other by-products of agricultural operations to facilitate secondary treatment. Use of these additives should be in accordance with the NRCS Conservation Practice Standard 591, Amendments for Treatment of Agricultural Waste.

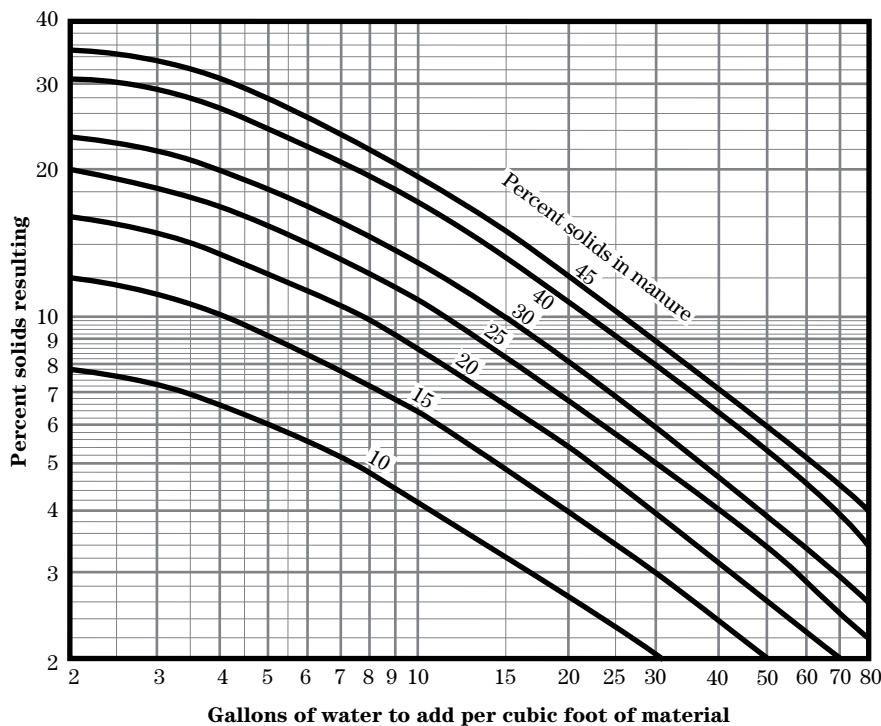
### (2) Anaerobic lagoons

Anaerobic lagoons are widely accepted in the United States for the treatment of manure. Anaerobic treatment of manure helps to protect water quality by reducing much of the organic concentration (BOD, COD) of the material. Anaerobic lagoons also reduce the nitrogen content of the material through ammonia volatilization and effectively reduce manure odors if the lagoon is managed properly. Anaerobic lagoons should be planned and designed in accordance with NRCS Conservation Practice Standard 359, Waste Treatment Lagoon.

**Design**—The maximum operating level of an anaerobic lagoon is a volume requirement plus a depth requirement. The volume requirement is the sum of the following volumes:

- minimum treatment volume,  $\text{ft}^3$  (MTV)
- manure volume, wastewater volume, and clean water,  $\text{ft}^3$  (WV)
- sludge volume,  $\text{ft}^3$  (SV)

**Figure 10–25** Design aid to determine quantity of water to add to achieve a desired TS concentration (USDA 1975)



The depth requirement is the normal precipitation less evaporation on the lagoon surface.

Polluted runoff from a watershed must not be included in a lagoon unless a defensible estimate of the volatile solid loading can be made. Runoff from a watershed, such as a feedlot, is not included in a lagoon because loading would only result during storm events and because the magnitude of the loading would be difficult, if not impossible, to estimate. As a result, the lagoon would be shocked with an overload of volatile solids.

If an automatic outflow device, pipe, or spillway is used, it must be placed at a height above the maximum operating level to accommodate the 25-year, 24-hour storm precipitation on the lagoon surface. This depth added to the maximum operating level of the lagoon establishes the level of the required volume or the outflow device, pipe, or spillway. A minimum of 1 foot of freeboard is provided above the outflow and establishes the top of the embankment. Should State regulation preclude the use of an outflow device, pipe, or spillway or if for some other reason the lagoon will not have these, the minimum freeboard is 1 foot above the top of the required volume.

The combination of these volumes and depths is illustrated in figure 10–26. The terms and derivation are explained in the following paragraphs.

Anaerobic waste treatment lagoons are designed on the basis of volatile solids loading rate (VSLR) per 1,000 cubic feet. Volatile solids represent the amount of solid material in wastes that will decompose as opposed to the mineral (inert) fraction. The rate of solids decomposition in anaerobic lagoons is a function of temperature; therefore, the acceptable VSLR varies from one location to another. Figure 10–27 indicates the maximum VSLRs for the United States. If odors need to be minimized, VSLR should be reduced by 25 to 50 percent.

The MTV represents the volume needed to maintain sustainable biological activity. The MTV for volatile solids (VS) can be determined using equation 10–4.

$$MTV = \frac{TVS}{VSLR} \quad (\text{eq. 10-4})$$

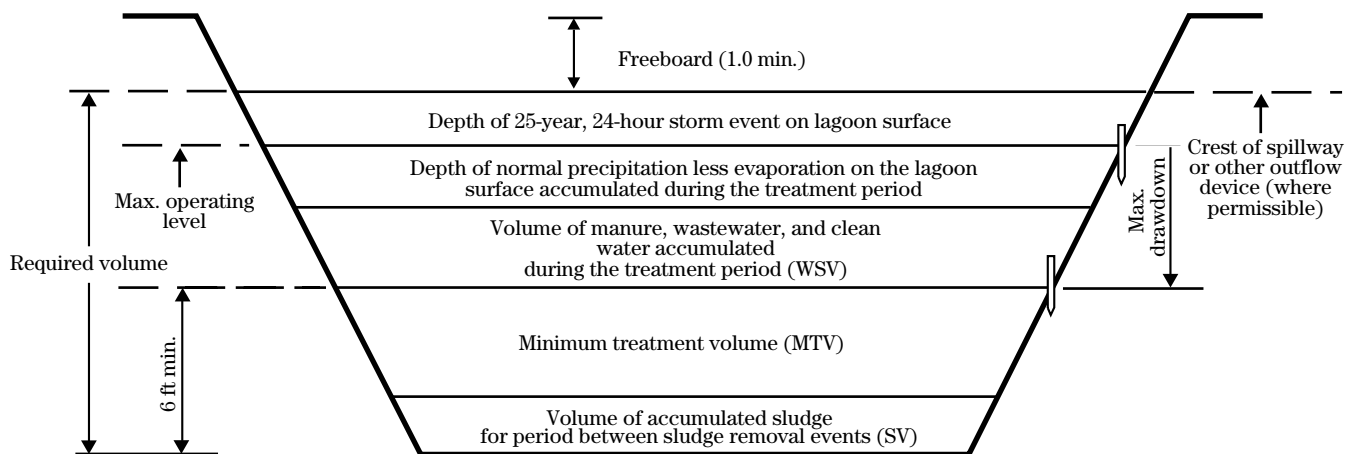
where:

MTV = minimum treatment volume, ft<sup>3</sup>

TVS = total daily volatile solids loading (from all sources), lb/d

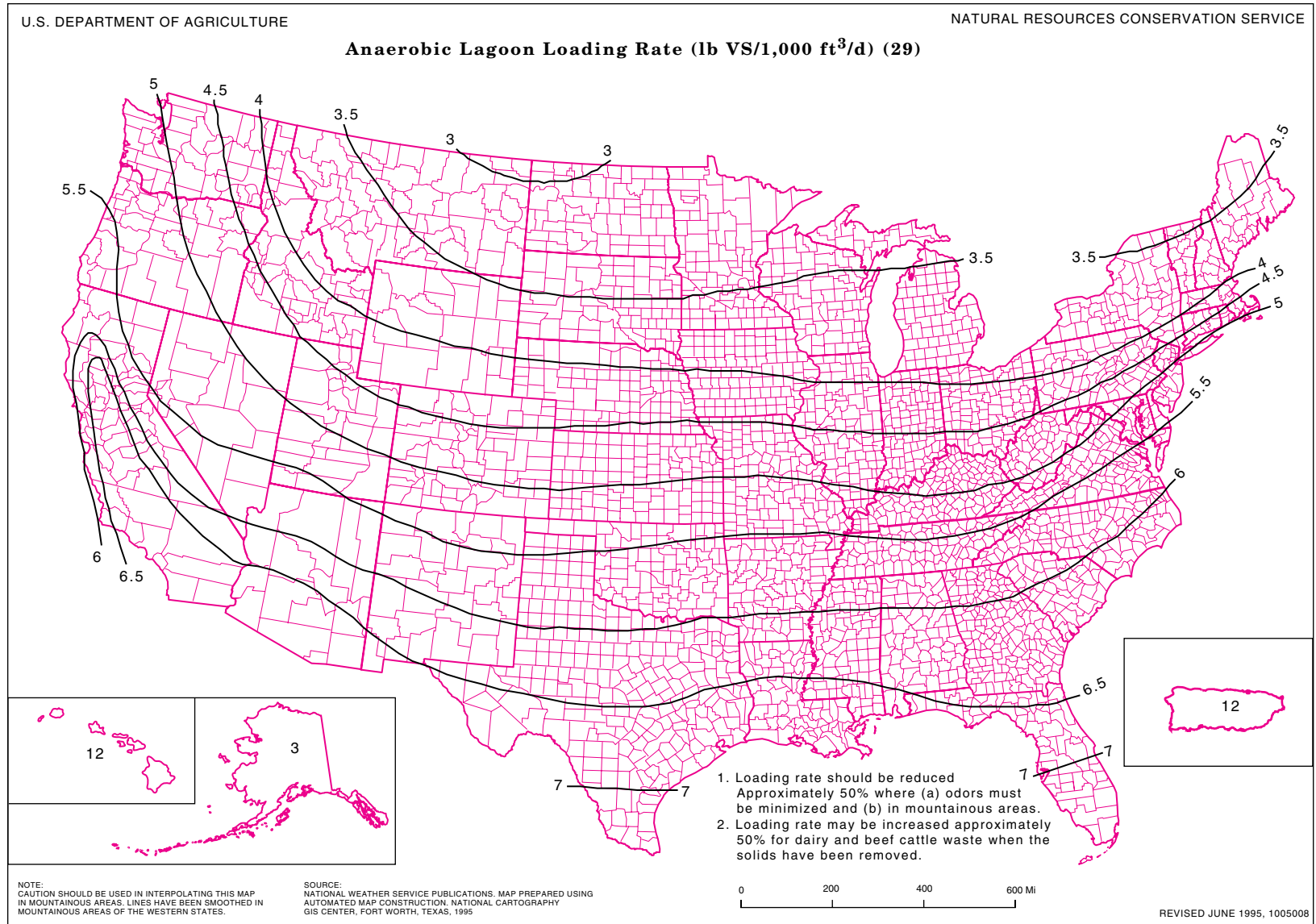
VSLR = volatile solids loading rate, lb/1,000 ft<sup>3</sup>/d (from fig. 10–27)

**Figure 10–26** Anaerobic lagoon cross section



Note: The minimum treatment volume for an anaerobic waste treatment lagoon is based on volatile solids.

**Figure 10-27** Anaerobic lagoon loading rate (lb VS/1,000 ft<sup>3</sup>/d)



Daily VS production for various wastes can be determined using tables in AWMFH, chapter 4. If feed spillage exceeds 5 percent, VSP should be increased by 4 percent for each additional 1 percent spillage.

Waste volume (WV) should reflect the actual volume of manure, wastewater, flushwater that will not be recycled, and clean dilution water added to the lagoon during the treatment period. The treatment period is either the detention time required to obtain the desired reduction of pollution potential of the waste or the time between land application events, whichever is longer. State regulations may govern the minimum detention time. Generally, the maximum time between land application events determines the treatment period because this time generally exceeds the detention time required.

$$WV = TVM + TWW + CW \quad (\text{eq. 10-5})$$

where:

- WV = waste volume for treatment period, ft<sup>3</sup>
- TVM = total volume of manure for treatment period, ft<sup>3</sup>
- TWW = total volume of wastewater for treatment period, ft<sup>3</sup>
- CW = clean water added during treatment period, ft<sup>3</sup>

In the absence of site-specific data, values in AWMFH, chapter 4, may be used to make estimates of the volumes.

As the manure is decomposed in the anaerobic lagoon only part of the TS is reduced. Some of the TS is mineral material that will not decompose, and some of the VS require a long time to decompose. These materials, referred to as sludge, gradually accumulate in the lagoon. To maintain the MTV, the volume of sludge accumulation over the period of time between sludge removal must be considered. Lagoons are commonly designed for a 15- to 20-year sludge accumulation period. The sludge volume (SV) can be determined using equation 10-6.

$$SV = 365 \times AU \times TS \times SAR \times T \quad (\text{eq. 10-6})$$

where:

- SV = sludge volume (ft<sup>3</sup>)
- AU = equivalent 1,000-pound animal (live weight)
- T = sludge accumulation time (yr)

TS = total solids production per AU per day (lb/AU/d)

SAR = sludge accumulation ratio (ft<sup>3</sup>/lb TS)

TS values can be obtained from the tables in AWMFH, chapter 4. Sludge accumulation ratios (SAR) should be taken from table 10-7. An SAR is not available for beef, but it can be assumed to be similar to that for dairy cattle.

The lagoon volume requirements are for accommodation of the MTV, the SV, and the waste volume for the treatment period. This is expressed in equation 10-7.

$$LV = MTV + SV + WV \quad (\text{eq. 10-7})$$

where:

- LV = lagoon volume requirement, ft<sup>3</sup>
- MTV = minimum treatment volume, ft<sup>3</sup> (see eq. 10-4)
- SV = sludge volume accumulation for period between sludge removal events, ft<sup>3</sup> (see eq. 10-6)
- WV = waste volume for treatment period, ft<sup>3</sup> (see eq. 10-5)

In addition to the lagoon volume requirement (LV), a provision must be made for depth to accommodate the normal precipitation less evaporation on the lagoon surface; the 25-year, 24-hour storm precipitation; the depth required to operate the emergency outflow; and freeboard. Normal precipitation on the lagoon surface is based on the critical treatment period that produces the maximum depth. This depth can be offset to some degree by evaporation losses on the lagoon surface. This offset varies, according to the climate of the region, from a partial amount of the precipitation to an amount in excess of the precipitation. Precipitation and evaporation can be determined from local climate data.

**Table 10-7** Sludge accumulation ratios (Barth 1985)

Animal type	SAR
Poultry	
Layers	0.0295
Pullets	0.0455
Swine	0.0485
Dairy cattle	0.0729

The minimum acceptable depth for anaerobic lagoons is 6 feet, but in colder climates at least 10 feet is recommended to assure proper operation and odor control.

The design height of an embankment for a lagoon should be increased by the amount needed to ensure that the design elevation is maintained after settlement. This increase should not be less than 5 percent of the design fill height. The minimum top width of the lagoon should be in accordance with NRCS Conservation Practice Standard 359, Waste Treatment Lagoon.

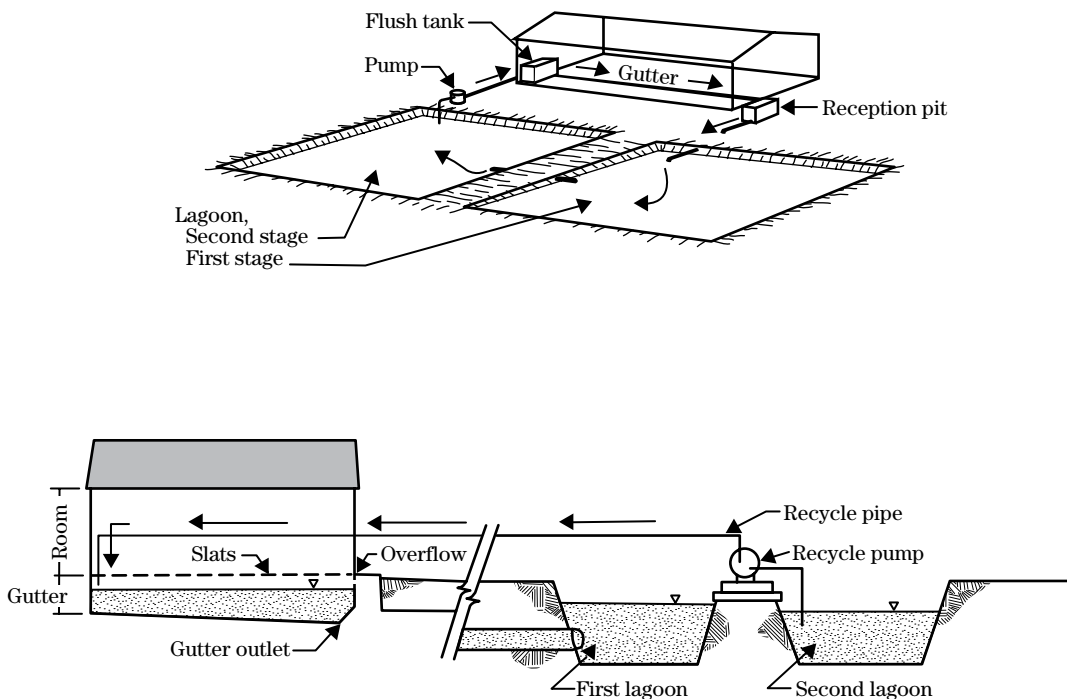
The combined side slopes of the settled embankment should not be less than 5 to 1 (horizontal to vertical). The inside slopes can vary from 1 to 1 for excavated slopes to 3 to 1 or flatter where embankments are used. Construction technique and soil type must also be considered. In some situations, a steep slope may be used below the design liquid level, while a flatter slope is used above the liquid level to facilitate maintenance and bank stabilization. The minimum eleva-

tion of the top of the settled embankment should be 1 foot above the maximum design water surface in the lagoon.

A lagoon should be constructed to avoid leakage and potential ground water pollution. Care in site selection, soils investigation, and design can minimize the potential for these problems. In cases where the lagoon needs to be sealed, the techniques discussed in AWMFH, chapter 7 can be used. Figure 10–28 shows two lagoon systems.

If overtopping can cause embankment failure, an emergency spillway or overflow pipe should be provided. A lagoon can have an overflow to maintain a constant liquid level if the overflow liquid is stored in a waste storage pond or otherwise properly managed. The inlet to a lagoon should be protected from freezing. This can be accomplished by using an open channel that can be cleaned out or by locating the inlet pipe below the freezing level in the lagoon. Because of possible blockages, access to the inlet pipe is needed.

**Figure 10–28** Anaerobic lagoon recycle systems



Venting inlet pipes prevents backflow of lagoon gases into the animal production facilities.

Sludge removal is an important consideration in the design. This can be accomplished by agitating the lagoon and pumping out the mixed sludge or by using a drag-line for removing floating or settled sludge. Some pumps can remove sludge, but not deposited rocks, sand, or grit. The sludge removal technique should be considered when determining lagoon surface dimensions. Many agitation pumps have an effective radius of 75 to 100 feet. Draglines may only reach 30 to 50 feet into the lagoon.

**Management**—Anaerobic lagoons must be managed properly if they are to function as designed. Specific instructions about lagoon operation and maintenance must be included in the overall waste management plan that is supplied to the decisionmaker. Normally, an anaerobic lagoon is managed so that the liquid level is maintained at or below the maximum operating level as shown in figure 10–26. The liquid level is lowered to the minimum treatment level at the end of the treatment period. It is good practice to install markers at the minimum treatment and maximum operating levels.

The minimum liquid level in an anaerobic lagoon before wastes are added should coincide with the MTV. If possible a lagoon should be put into service during the summer to allow adequate development of bacterial populations. A lagoon operates more effectively and has fewer problems if loading is by small, frequent (daily) inflow, rather than large, infrequent slug loads.

The pH should be measured frequently. Many problems associated with lagoons are related to pH in

some manner. The optimum pH is about 6.5. When pH falls below this level, methane-producing bacteria are inhibited by the free hydrogen ion concentration. The most frequent cause of low pH in anaerobic digestion is the shock loading of organic material that stimulates the facultative acid-producing bacteria. Add hydrated lime or lye if pH is below 6.5. Add 1 pound per 1,000 square feet daily until pH reaches 7.

Lagoons are designed based on a given loading rate. If an increase in the number of animals is anticipated, sufficient capacity to handle the entire expected wasteload should be available. The most common problem in using lagoons is overloading, which can lead to odors, malfunctioning, and complaints. When liquid removal is needed, the liquid level should not be dropped below the MTV plus SV levels. If evaporation exceeds rainfall in a series of dry years, the lagoon should be partly drawn down and refilled to dilute excess concentrations of nutrients, minerals, and toxics. Lagoons are typically designed for 15 to 20 years of sludge accumulation. After this time the sludge must be cleaned out before adding additional waste.

Sometimes operators want to use lagoon effluent as flushwater. To polish and store water for this purpose, waste storage ponds can be constructed in series with the anaerobic lagoon. The capacity of the waste storage pond should be sized for the desired storage volume. A minimum capacity of the waste storage pond is the volume for rainfall (RFV), runoff (ROV), and emergency storm storage (ESV). By limiting the depth to less than 6 feet, the pond will function more nearly like an aerobic lagoon. Odors and the level of ammonia, ammonium, and nitrate will be more effectively reduced.

### Design example 10–5 Anaerobic lagoon

Mr. Oscar Smith of Rocky Mount, North Carolina, has requested assistance in developing an agricultural waste management system for his 6,000 pig finishing facility. The alternative selected includes an anaerobic lagoon. The animals average 150 pounds. The 25-year, 24-hour storm for the area is 6 inches (appendix 10B). Mr. Smith needs 180-day intervals between

lagoon pumping. During this time, the net precipitation should be 2 inches, based on data from appendices 10B and 10C. He wants to use the lagoon for at least 5 years before removing the sludge. Worksheet 10A–3 is used to determine the necessary volume for this lagoon.

## Completed worksheet for Design example 10-5

## Worksheet 10A-3—Anaerobic lagoon design

Decisionmaker: <i>Oscar Smith</i>		Date: <i>6/13/90</i>	
Site: <i>Rocky Mount, NC</i>			
<b>Animal units</b>			
1. Animal type	<i>Growers</i>	3. Number of animals (N)	<i>6000</i>
2. Animal weight, lbs (W)	<i>150</i>	4. Animal units, $AU = \frac{W \times N}{1000}$	<i>900</i>
<b>Manure volume</b>		7. Total volume of manure production for animal type for treatment period, $ft^3$	
5. Daily volume of daily manure production per AU, $ft^3/AU/day$ (DVM) =	<i>1.1</i>	VMD = $AU \times DVM \times D$	<i>= 178,200</i> <i>178,200</i>
6. Treatment period, days (D) =	<i>180</i>	8. Total manure production for treatment period, $ft^3$ (TVM)	
<b>Wastewater volume</b>		11. Total wastewater volume for treatment period, $ft^3$ (TWW)	
9. Daily wastewater volume per AU, $ft^3/AU/day$ (DWW) =			<i>0</i>
10. Total wastewater volume for animal description for treatment period, $ft^3$			
WWD = $DWW \times AU \times D$ =			
<b>Clean water volume</b>			
12. Clean water added during treatment period, $ft^3$ (CW)			<i>0</i>
<b>Waste volume</b>			
13. Waste volume for treatment period, $ft^3$	$WV = TVM + TWW + CW = 178,200 + 0 + 0 = 178,200$		
<b>Manure total solids</b>		16. Total manure total solids production, lbs/day (TMTS) =	
14. Daily manure total solids production, lbs/AU/day (MTS) =	<i>6.5</i>		<i>5,850</i>
15. Daily manure total solids production for animal type, lbs/day			
MTSD = $MTS \times AU$ =	<i>5,850</i>		
<b>Manure volatile solids</b>		16. Total manure total solids production, lbs/day (TMTS) =	
17. Daily manure volatile solids production per AU, lbs/AU/day (MVS) =	<i>5.4</i>		<i>5,850</i>
18. Daily manure volatile solids production for animal type per day, lbs/day			
MVSD = $AU \times MVS$ =	<i>4860</i>		
19. Total manure volatile solids production, lbs/day (TMVS)			<i>4860</i>
<b>Wastewater volatile solids</b>			
20. Daily wastewater volatile solids production, lbs/1000 gal (DWVS)			
21. Total wastewater volatile solids production for animal type, lbs/day			
WVSD = $\frac{DWVS \times DWW \times 7.48}{D \times 1,000}$			
22. Total wastewater volatile solids production, lbs/day (TWVS)			<i>0</i>
<b>Total volatile solids (manure and wastewater)</b>			
23. Total daily volatile solids production, lbs/day	$TVS = TMVS + TWVS = 4860 + 0 = 4860$		
<b>Minimum treatment volume</b>		25. Minimum treatment volume, $ft^3$	
24. Selected lagoon VS loading rate, lbs VS/1,000 ft <sup>3</sup> (VSLR) =	<i>6</i>	MTV = $\frac{TVS \times 1000}{VSLR}$	$= \frac{(4860) \times 1000}{(6)} = 810,000$
<b>Sludge volume requirement</b>		28. Sludge volume requirement, $ft^3$	
26. Sludge accumulation ratio, $ft^3/lb$ TS (SAR) =	<i>0.0485</i>	SV = $365 \times TMTS \times T \times SAR$	
27. Sludge accumulation period, years (T) =	<i>5</i>		$= 365 \times (5,850) \times (5) \times (0.0485) = 517,798$
<b>Minimum lagoon volume requirement</b>			
29. Minimum lagoon volume requirements, $ft^3$			
(MLVR) = $MTV + SV + WV$ =	<i>810,000</i>	<i>517,798</i>	<i>178,200</i> = <i>1,505,998</i>



**Completed worksheet for Design example 10-5—Continued****Worksheet 10A-3—Anaerobic lagoon design—Continued****Lagoon sizing**

30. Sizing by trial and error  $V = \frac{(4 \times Z^2 \times d^3)}{3} + (Z \times BL \times d^2) + (Z \times BW \times d^2) + (BW \times BL \times d)$

Side slope ratio, (Z) = 2

V must be equal to or greater than MLVR = 1,505,998 ft<sup>3</sup>

Trial no.	Bottom width ft (BW)	Bottom length ft (BL)	Depth* ft (d)	Volume ft <sup>3</sup> (V)
<u>1</u>	<u>150</u>	<u>1000</u>	<u>8</u>	<u>1,349,931</u>
<u>2</u>	<u>150</u>	<u>1100</u>	<u>8</u>	<u>1,482,731</u>
<u>3</u>	<u>150</u>	<u>1125</u>	<u>8</u>	<u>1,515,931 ~ MLVR</u>

\* Depth must be adjusted in Step 31.

**Depth adjustment**

## 31. Depth adjustment

Depth, ft (d) ..... 8

Add depth of precipitation less evaporation on lagoon surface ..... + 0.6  
(for the treatment period)

Add depth of 25-year, 24-hour storm ..... + 0.5

Add for freeboard (1.0 foot minimum) ..... + 1.0

Final depth ..... 10.1

32. Compute total volume using final depth, ft<sup>3</sup> (use equation in step 30) ..... 1,969,995

### (3) Aerobic lagoons

Aerobic lagoons can be used if minimizing odors is critical (fig. 10–29). These lagoons operate within a depth range of 2 to 5 feet to allow for the oxygen entrainment that is necessary for the aerobic bacteria.

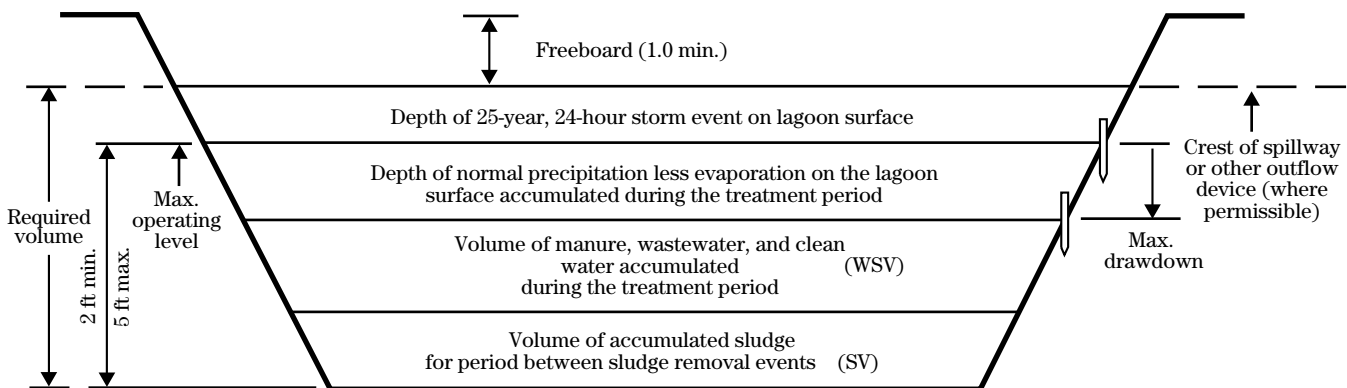
The design of aerobic lagoons is based on the amount of biochemical oxygen demand ( $BOD_5$ ) added per day. If local data are not available, use the  $BOD_5$  values from the tables in AWMFH, chapter 4. Figure 10–30 shows the acceptable aerobic loading rates for the United States in pounds  $BOD_5$  per acre per day. The lagoon surface area at the average operating depth is sized so that the acceptable loading rate is not exceeded.

Even though an aerobic lagoon is designed on the basis of surface area, it must have enough capacity to accommodate the waste volume (WV) and sludge volume (SV). In addition, depth must be provided to

accommodate the normal precipitation less evaporation on the lagoon surface, the 25-year, 24-hour storm precipitation on the lagoon surface, and freeboard. Should State regulations not permit an emergency outflow or for some other reason one is not used, the minimum freeboard is 1 foot above the top of the required volume. Figure 10–29 demonstrates these volume depth requirements.

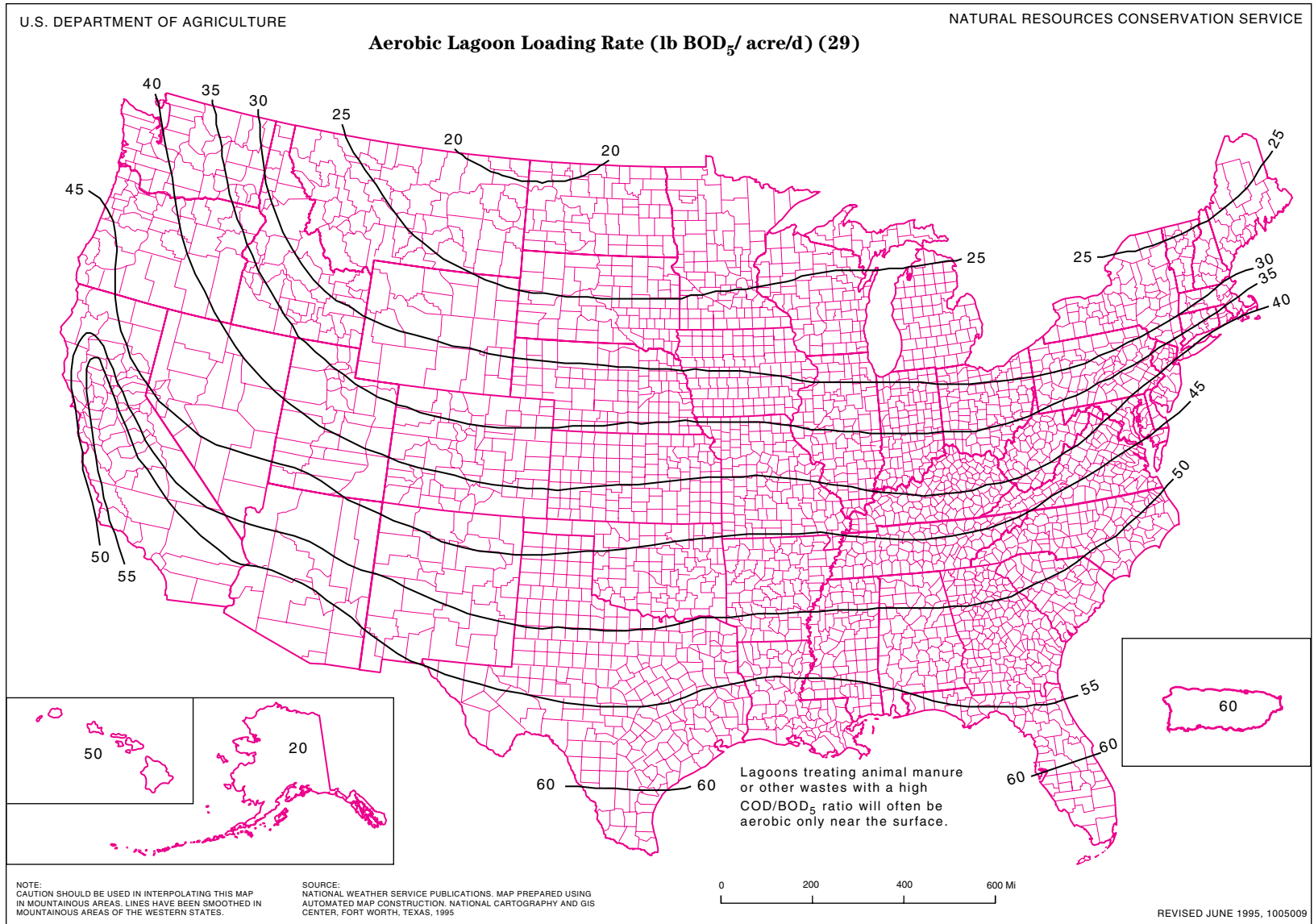
Aerobic lagoons need to be managed similarly to anaerobic lagoons in that they should never be overloaded with oxygen demanding material. The lagoon should be filled to the minimum operating level, generally 2 feet, before being loaded with waste. The maximum liquid level should not exceed 5 feet. The water level must be maintained within the designed operating range. Sludge should be removed when it exceeds the designed sludge storage capacity. Aerobic lagoons should also be enclosed in fences and marked with warning signs.

**Figure 10–29** Aerobic lagoon cross section



Note: An aerobic waste treatment lagoon has a required minimum surface area based on  $BOD_5$

**Figure 10-30** Aerobic lagoon loading rate (lb BOD<sub>5</sub>/acre/d)



(210-VI-AWMPH, Amend. 31, August 2009)

**Design example 10–6    Aerobic lagoon**

Mr. John Sims of Greenville, Mississippi, has requested assistance on the development of an agricultural waste management system. He has requested that an alternative be developed that includes an aero-

bic lagoon to treat the waste from his 50,000 caged layers, which have an average weight of 4 pounds. Completed worksheet 10A–4 shows the calculations to size the lagoon for this design example.

## Worksheet 10A-4—Aerobic lagoon design

Decisionmaker: <i>John Sims</i>		Date: <i>11/16/90</i>	
Site: <i>Greenville, MS</i>			
<b>Animal units</b>			
1. Animal type	<i>Caged Layers</i>	3. Number of animals (N)	<i>50,000</i>
2. Animal weight, lbs (W)	<i>4</i>	4. Animal units, $AU = \frac{W \times N}{1000}$	<i>200</i>
<b>Manure volume</b>			
5. Daily volume of daily manure production per AU, $ft^3/AU/day$ (DVM) =	<i>0.93</i>	7. Total volume of manure production for animal type for treatment period, $ft^3$ $VMD = AU \times DVM \times D$	<i>33,480</i>
6. Treatment period, days (D) =	<i>180</i>	8. Total manure production for treatment period, $ft^3$ (TVM)	<i>33,480</i>
<b>Wastewater volume</b>			
9. Daily wastewater volume per AU, $ft^3/AU/day$ (DWW) =		11. Total wastewater volume for treatment period, $ft^3$ (TWW)	<i>0</i>
10. Total wastewater volume for animal description for treatment period, $ft^3$ $WWD = DWW \times AU \times D =$			
<b>Clean water volume</b>			
12. Clean water added during treatment period, $ft^3$ (CW)			<i>0</i>
<b>Waste volume</b>			
13. Waste volume for treatment period, $ft^3$ $WV = TVM + TWW + CW =$	<i>33,480</i>	<i>0</i>	<i>0</i>
<b>Manure total solids</b>			
14. Daily manure total solids production, lbs/AU/day (MTS) =	<i>15</i>	16. Total manure total solids production, lbs/day (TMTS) =	<i>3000</i>
15. Daily manure total solids production for animal type, lb/day $MTSD = MTS \times AU =$	<i>3000</i>		
<b>Manure 5-day biochemical oxygen demand</b>			
17. Daily manure $BOD_5$ production per AU, lbs/AU/day (MBOD) =		<i>3.3</i>	
18. Daily manure $BOD_5$ production for animal type per day, lbs/day $MBOD = AU \times BOD =$	<i>660</i>		
19. Total manure production, lbs/day (TMBOD)			<i>660</i>
<b>Wastewater 5-day biochemical oxygen demand</b>			
20. Daily wastewater $BOD_5$ production, lbs/1000 gal (DWBOD) =			
21. Total wastewater $BOD_5$ production for animal type, lbs/day $WBOD = \frac{(DWBOD \times TWW \times 7.48)}{D \times 1,000}$			
22. Total wastewater $BOD_5$ production, lbs/day (TWBOD)			<i>0</i>
<b>TOTAL <math>BOD_5</math> (manure and wastewater)</b>			
23. Total daily production, lbs/day $TBOD = TMBOD + TWBOD =$	<i>660</i>	<i>0</i>	<i>660</i>
<b>Minimum treatment surface area</b>			
24. Selected lagoon $BOD_5$ loading rate, lbs $BOD_5$ /acre (BODLR) =	<i>50</i>	25. Minimum treatment surface area, acres $MTA = \frac{TBOD}{BODLR} = \frac{(660)}{(50)} =$	<i>13.2</i>
<b>Sludge volume requirement</b>			
26. Sludge accumulation ratio, $ft^3/lb$ TS (SAR) =	<i>0.0295</i>	28. Sludge volume requirement, $ft$ $SV = 365 \times TMTS \times T \times SAR$	
27. Sludge accumulation period, years (T) =	<i>5</i>	$= 365 (3000) (5) (0.0295) =$	<i>161,513</i>
<b>Minimum lagoon volume requirement</b>			
29. Minimum lagoon volume requirements, $ft^3$ $MLVR = SV + WV =$	<i>161,513</i>	<i>33,480</i>	<i>194,993</i>

Worksheet 10A-4—Aerobic Lagoon Design—Continued

**Lagoon sizing**

30. Sizing by trial and error:

Side slope ratio, (Z) = 4

V must be equal to or greater than MLVR = 194,993 ft<sup>3</sup>

SA must be equal to or greater than MTA = 13.2 acres

Rectangular lagoon:

d must be less than 5 feet

$$SA = \frac{(BL + 2Zd)(BW + 2Zd)}{43,560}$$

Trial no.	Bottom width ft (BW)	Bottom length ft (BL)	Depth* ft (d)	Volume ft <sup>3</sup> (V)	Surface area acres (SA)
<u>1</u>	<u>500</u>	<u>1000</u>	<u>0.5</u>	<u>251,503</u>	<u>11.6</u>
<u>2</u>	<u>600</u>	<u>1000</u>	<u>0.5</u>	<u>301,603</u>	<u>13.9</u>
<u>3</u>	<u>570</u>	<u>1000</u>	<u>0.5</u>	<u>286,573</u>	<u>13.2 OK</u>

\* Depth must be adjusted in Step 31

**Depth adjustment**

31. Depth adjustment

Depth, ft (d) ..... 0.5

Add depth of precipitation less evaporation on lagoon surface + 0.5  
(for the treatment period)

Add depth of 25-year, 24-hour storm ..... + 0.6

Add for freeboard (1.0 foot minimum) ..... + 1.0

Final depth ..... 2.6

32. Compute total volume using final depth<sup>3</sup>ft  
(use equation in step 30) ..... 1,524,828

**(4) Mechanically aerated lagoons**

*Much of this material was taken directly from technical notes on the design of mechanically aerated lagoons for odor control (USDA SCS 1980).*

Aerated lagoons operate aerobically and are dependent on mechanical aeration to supply the oxygen needed to treat waste and minimize odors. This type of design is used to convert an anaerobic lagoon to an aerobic condition, or as an alternative, to a naturally aerated lagoon that would otherwise need to be much larger. Mechanically aerated lagoons combine the small surface area feature of anaerobic lagoons with relative odor-free operation of an aerobic lagoon. The main disadvantages of this type of lagoon are the energy requirements to operate the mechanical aerators and the high level of management required.

The typical design includes 1 pound of oxygen transferred to the lagoon liquid for each pound of BOD<sub>5</sub> added. The TS content in aerated lagoons should be maintained between 1 and 3 percent with dilution water. The depth of aerated lagoons depends on the type of aerator used. Agitation of settled sludge needs to be avoided. As with naturally aerobic lagoons, consideration is required for storage of manure and rainfall.

Two kinds of mechanical aerator are used: the surface pump and the diffused air system. The surface pump floats on the surface of the lagoon, lifting water into the air, thus assuring an air-water mixture. The diffused air system pumps air through water, but is generally less economical to operate than the surface pump.

**(i) Lagoon loading**

Lagoon loading should be based on 5-day BOD<sub>5</sub> or carbonaceous oxygen demand (COD). NRCS designs on the basis of BOD<sub>5</sub>. The tables in AWMFH, chapter 4 show recommended BOD<sub>5</sub> production rates, but local data should be used where available.

**(ii) Aerator design**

Aerators are designed primarily on their ability to transfer oxygen (O<sub>2</sub>) to the lagoon liquid. Of secondary importance is the ability of the aerator to mix or disperse the O<sub>2</sub> throughout the lagoon. Where the aerator is intended for minimizing odors, complete mixing is not a consideration except as it relates to the surface area.

For the purpose of minimizing odors, aerators should transfer from 1 to 2 pounds of oxygen per pound of BOD<sub>5</sub>. Even a limited amount of oxygen transfer (as little as 1/3 lb O<sub>2</sub>/lb BOD<sub>5</sub>) reduces the release of volatile acids and accompanying gases. For design purposes, use 1 pound of oxygen per pound of BOD<sub>5</sub> unless local research indicates a higher value is needed.

Aerators are tested and rated according to their clean water transfer rate (CWTR) or laboratory transfer rate (LTR), whichever term is preferred. The resulting value is given for transfer at standard atmospheric pressure (14.7 lb/in<sup>2</sup>), dissolved oxygen equal to 0 percent, and water at 20 degrees Celsius. The actual transfer rate expected in field operation can be determined by using equation 10-8.

$$FTR = CWTR \times \frac{(B \times C_{dc}) - DO}{C_{sc}} \times O^{t-20} \times a \quad (\text{eq. 10-8})$$

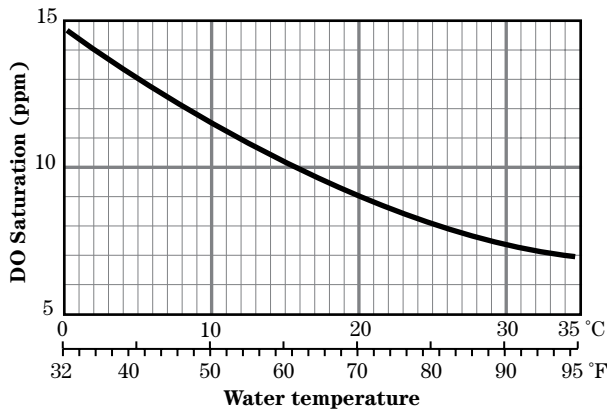
where:

- FTR = lb O<sub>2</sub> per horsepower-hour transferred under field conditions
- CWTR = clean water transfer rate in lb per horsepower-hour transferred under standard laboratory conditions
- B = salinity-surface tension factor. It is the ratio of the saturated concentration in the wastewater to that of clean water. Values range from 0.95 to 1.0.
- C<sub>dc</sub> = O<sub>2</sub> saturation concentration at design conditions of altitude and temperature (mg/L) from figures 10-31 and 10-32
- DO = average operating O<sub>2</sub> concentration (mg/L). The recommended value of DO can vary from 1 to 3 depending on the reference material. A value of 1.5 should be considered a minimum. For areas where minimizing odors is particularly critical, a DO of 2 or more should be used.
- t = design temperature (°C)
- O = temperature correction factor; values range from 1.024 to 1.035
- a = ratio of the rate of O<sub>2</sub> transfer in the wastewater to that of clean water. Generally taken as 0.75 for animal waste
- C<sub>sc</sub> = saturation concentration of O<sub>2</sub> in clean water, 20 °C and sea level (9.17 mg/L)

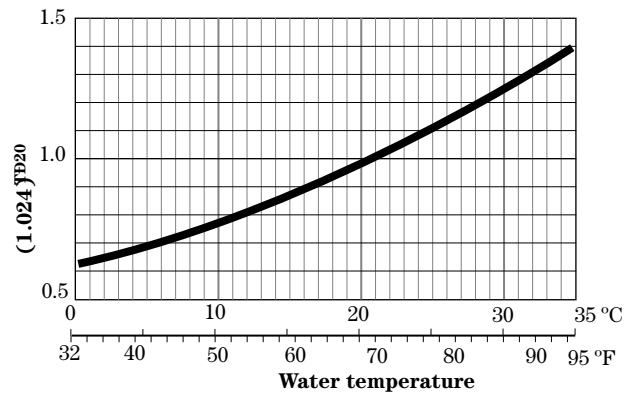
Unless local information supports using other values, the following values for calculating field transfer rates should be used:  $B=1.0$ ,  $DO=1.5$ ,  $O=1.024$ ,  $a=0.75$ , and  $C_{sc} = 9.17$ .

Figure 10-33 provides a quick solution to the term  $O^{t-20}$ , where  $O$  is equal to 1.024. Designs for both summer and winter temperatures are often necessary to determine the controlling (least) transfer rate.

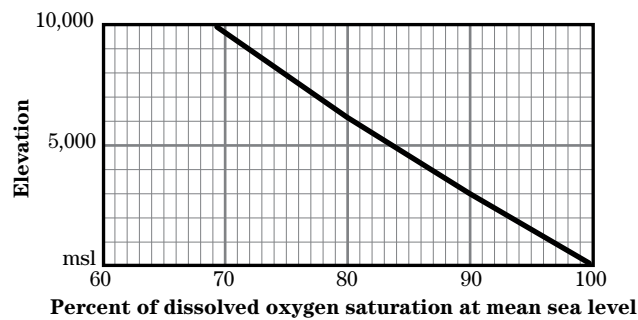
**Figure 10-31** Relation of dissolved oxygen saturation to water temperature (clean water at 20 °C and sea level)



**Figure 10-33** Numeral values for  $O^{t-20}$  at different temperatures where  $O=1.024$



**Figure 10-32** Relation of dissolved oxygen saturation to elevation above mean sea level





Having calculated FTR, the next step is to determine horsepower requirements of aeration based on loading rates and FTR as calculated above. Horsepower requirements can be estimated using equation 10-9.

$$HP = \frac{BOD_5}{FTR \times HO} \quad (\text{eq. 10-9})$$

where:

HP = horsepower

BOD<sub>5</sub> = 5-day BOD<sub>5</sub> loading of waste, lb/d

HO = hours of operation per day

Most lagoon systems should be designed on the basis of continual aerator operations.

The actual selection of aerator(s) is a subjective process and often depends on the availability of models in the particular area. In general, multiple small units are preferred to one large unit. The multiple units provide better coverage of the surface area, as well as permit flexibility for the real possibility of equipment failure and reduced aeration.

### (5) Oxidation ditches

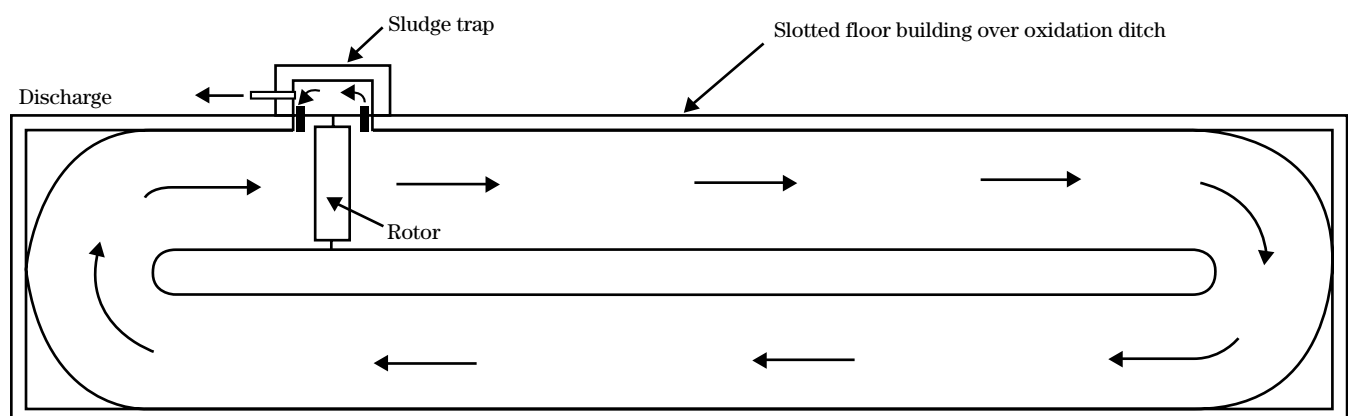
In some situations, sufficient space is not available for a lagoon for treating animal waste, and odor control is critical. One option for treating animal waste under these circumstances is an oxidation ditch (fig. 10-34).

The shallow, continuous ditch generally is in an oval layout. It has a special aerator spanning the channel. The action of the aerator moves the liquid waste around the channel and keeps the solids in suspension. Because of the need for continuous aeration, this process can be expensive to operate. Oxidation ditches should only be designed by a professional engineer familiar with the process.

The range of loading for an oxidation ditch is 1 pound of BOD<sub>5</sub> per 30 to 100 cubic feet of volume. This provides for a retention time of 30 to 70 days. Solids accumulate over time and must be removed by settling. The TS concentration is maintained in the 2 to 6 percent range, and dilution water must be added periodically.

If oxidation ditches are not overloaded, they work well for minimizing odors. The degree of management required, however, may be more than desired by some operators. Daily attention is often necessary, and equipment failure can lead to toxic gas generation soon after the aerators are stopped. If the ditches are properly managed, they can be effective in reducing nitrogen to N<sub>2</sub> through cyclic aerobic/anaerobic periods, which allows nitrification and then denitrification.

**Figure 10-34** Schematic of an oxidation ditch



**(6) Composting**

Composting is the aerobic biological decomposition of organic matter. It is a natural process that is enhanced and accelerated by the mixing of organic waste with other ingredients in a prescribed manner for optimum microbial growth.

Composting converts an organic waste material into a stable organic product by converting nitrogen from the unstable ammonia form to a more stable organic form. The end result is a product that is safer to use than raw organic material and one that improves soil fertility, tilth, and water holding capacity. In addition, composting reduces the bulk of organic material to be spread; improves its handling properties; reduces odor, fly, and other vector problems; and can destroy weed seeds and pathogens. Composters should be planned and designed in accordance with NRCS Conservation Practice Standard 317, Composting Facility.

**Composting methods**—Descriptions of three basic methods of composting—windrow, static pile, and in-vessel—follow.

**Windrow method**—the windrow method involves the arrangement of compost mix in long, narrow piles or windrows (fig. 10–35). To maintain an aerobic condition, the compost mixture must be periodically turned. This exposes the decomposing material to the air and keeps temperatures from getting too high (>170 °F). The minimum turning frequency varies from 2 to 10 days, depending on the type of mix, volume, and ambient air temperature. As the compost ages, the frequency of turning can be reduced.

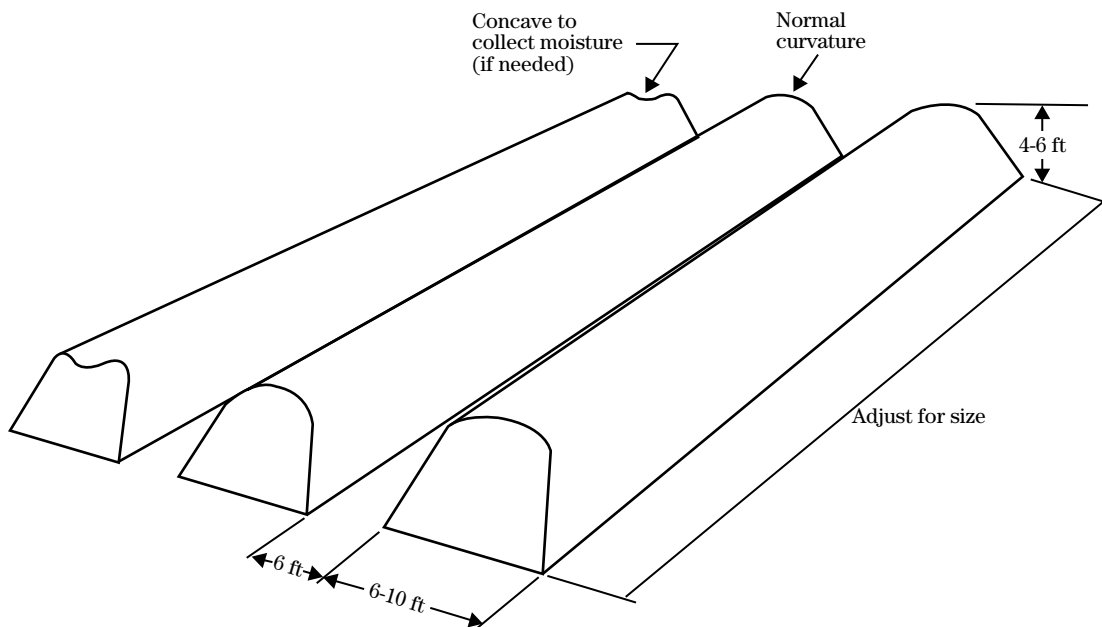
The width and depth of the windrows are limited only by the type of turning equipment used. Turning equipment can range from a front-end loader to an automatic mechanical turner. Windrows generally are 4 to 6 feet deep and 6 to 10 feet wide.

Some advantages and disadvantages of the windrow method include:

Advantages:

- rapid drying with elevated temperatures
- drier product, resulting in easier product handling

**Figure 10–35** Windrow schematic



- ability to handle high volumes of material
- good product stabilization
- low capital investment

## Disadvantages:

- not space efficient
- high operational costs
- piles should be turned to maintain aerobic conditions
- turning equipment may be required
- vulnerable to climate changes
- odors released on turning of compost
- large volume of bulking agent might be required

*Static pile method*—the static pile method consists of mixing the compost material and then stacking the mix on perforated plastic pipe or tubing through which air is drawn or forced. Forcing air through the compost pile may not be necessary with small compost piles that are highly porous or with a mix that is stacked in layers with highly porous material. The exterior of the pile generally is insulated with finished compost or other material. In nonlayered operations, the materials to be composted must be thoroughly blended before pile placement.

The dimensions of the static pile are limited by the amount of aeration that can be supplied by the blowers and the stacking characteristics of the waste. The compost mixture height generally ranges from 8 to 15 feet, and the width is usually twice the depth. Individual piles generally are spaced about a half the distance of the height.

With forced air systems, air movement through the pile occurs by suction (vacuum) or by positive pressure (forced) through perforated pipes or tubing. A filter pile or material is normally used to absorb odor if air is sucked through the pile (fig. 10–36).

Some advantages and disadvantages of the static pile method include:

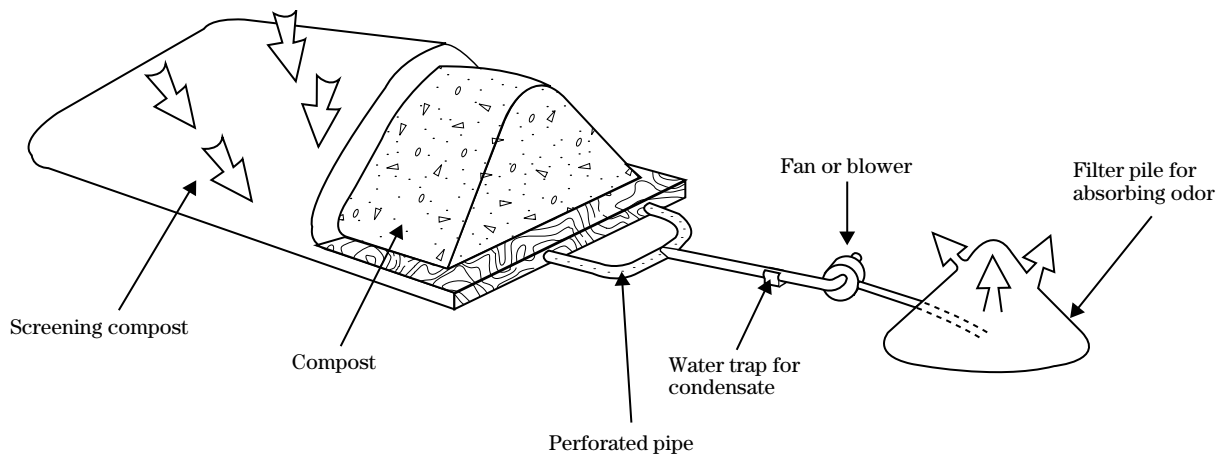
## Advantages:

- low capital cost
- high degree of pathogen destruction
- good odor control
- good product stabilization

## Disadvantages:

- not space efficient
- vulnerable to climate impacts
- difficult to work around perforated pipe unless recessed
- operating cost and maintenance on blowers

**Figure 10–36** Static pile composting schematic



*In-vessel method*—the in-vessel method involves the mixing of manure or other organic waste with a bulking agent in a reactor, building, container, or vessel (fig. 10–37) and may involve the addition of a controlled amount of air over a specific detention time. This method has the potential to provide a high level of process control because moisture, aeration, and temperature can be maintained with some of the more sophisticated units.

Some of the advantages and disadvantages of the in-vessel method include:

Advantages:

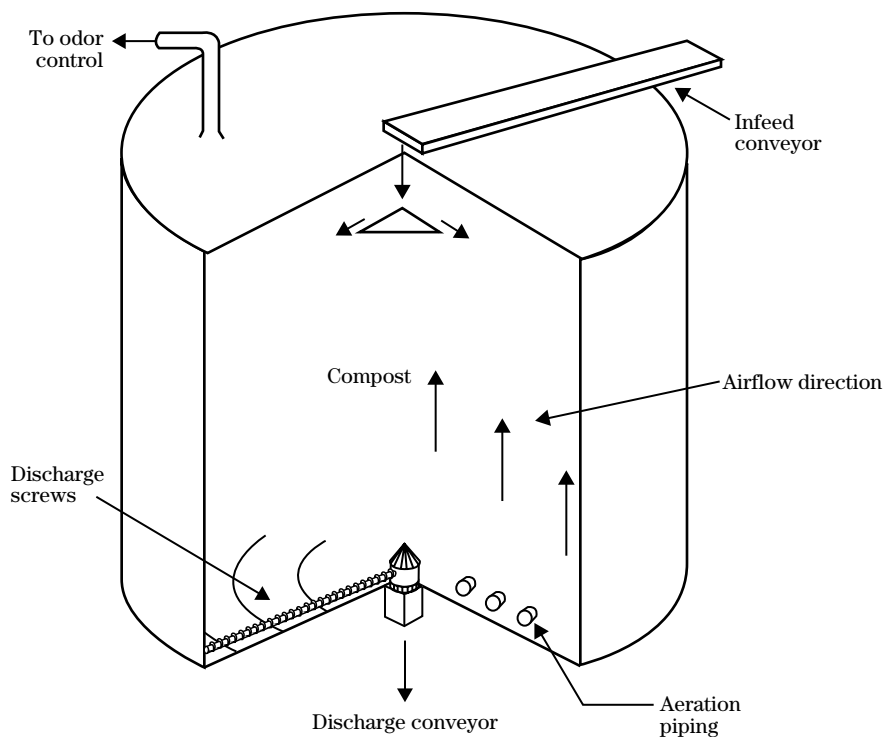
- space efficient
- good process control because of self-containment
- Protection from adverse climate conditions
- good odor control because of self-containment and process control

- potential for heat recovery dependent on system design
- can be designed as a continuous process rather than a batch process

Disadvantages:

- high capital cost for sophisticated units
- lack of operating data, particularly for large systems
- careful management required
- dependent on specialized mechanical and electrical equipment
- potential for incomplete stabilization
- mechanical mixing needs to be provided
- less flexibility in operation mode than with other methods

**Figure 10–37** In-vessel composting schematic



**Method selection**—The composting method must fit the individual farm operation. Highly sophisticated and expensive composting operations are not likely to be a viable option for small farming operations. Some factors to consider when selecting the particular method of composting include:

**Operator management capability**—the management capability of the operator is an important consideration when selecting the right composting method. Even simple composting methods require that the operator spend additional time in monitoring and material handling. The operator should fully understand the level of management that is required. The windrow method generally is the simplest method to manage, but requires additional labor for periodically turning the compost mix. The static pile is generally next in complexity because of having to maintain blowers and work around perforated pipe. In-vessel composting can be the simplest or the most difficult to manage, depending on the sophistication of the system.

**Equipment and labor availability**—consider what equipment is available for loading, unloading, turning, mixing, and hauling. The windrow method requires extra equipment and labor to periodically turn the rows. All methods require some type of loading and unloading equipment.

**Site features**—if a limited amount of space is available, the static pile or in-vessel method may be the only viable composting alternatives. Proximity to neighbors and the appearance of the compost operation may make the windrow and static pile methods unattractive alternatives. If the only composting site has limited accessibility, the static pile or in-vessel method should be considered because of less mixing requirements. Siting considerations are discussed more fully in the siting and area considerations section that follows.

**Compost utilization**—if the compost is to be marketed commercially, a composting method that produces a predictable, uniform product should be considered. Because of varying climatic conditions, the windrow method may not produce a predictable end product. Sophisticated in-vessel methods provide the most process control; therefore, they produce the most uniform and predictable product.

**Climate**—in extremely wet climates, the static pile and aerated composting methods may become too wet to compost properly unless measures are taken to protect the compost from the weather. In very cold climates, the composting process may slow in the winter. Sheltering the compost pile from the wind helps to prevent a slowdown in the composting process. The windrow and static pile methods are the most vulnerable to freezing temperatures because they are exposed to the elements. All methods may perform unsatisfactorily if the organic waste and amendments are initially mixed in a frozen state.

**Cost**—composting capital and operating costs vary considerably depending on the degree of sophistication. The windrow method generally has the least capital cost, but also has the most operational costs. The in-vessel method usually has the highest initial capital cost, but the lowest operational cost.

**Siting and area considerations**—The location of the composting facility is a very important factor in a successful compost operation. To minimize material handling, the composting facility should be located as close as possible to the source of organic waste. If land application is the preferred method of utilization, the facility should also be located with convenient access to the land application sites. Several other important considerations when locating a compost facility follow.

**Wind direction**—improperly managed compost facilities may generate offensive odors until corrective actions are taken. Wind direction and proximity to neighbors should be considered when locating a composting facility.

**Topography**—avoid locating composting facilities on steep slopes where runoff may be a problem and in areas where the composting facility will be subject to inundation.

**Ground water protection**—the composting facility should be located downgradient and at a safe distance from any wellhead. A roofed compost facility that is properly managed should not generate leachate that could contaminate ground water. If a compost facility is not protected from the weather, it should be sited to minimize the risk to ground water.

*Area requirements*—the area requirements for each composting method vary. The windrow method requires the most land area. The static pile method requires less land area than the windrow method, but more than the in-vessel method. The pile dimensions also affect the amount of land area necessary for composting. A large pile that has a low surface area to total volume ratio requires less composting area for a given volume of manure, but it is also harder to manage. The size and type equipment used to mix, load, and turn the compost should also be considered when sizing a compost area. Enough room must be provided in and around the composting facility to operate equipment. In addition, a buffer area around the compost site should be considered if a visual barrier is needed or desired. In general, given the pile dimensions, a compost bulk density of 35 to 45 pounds per cubic feet can be used to estimate the surface area necessary for stacking the initial compost mix. To this area, add the amount of area necessary for equipment operation, pile turning, and buffer.

*Existing areas*—to reduce the initial capital cost, existing roofed, concrete, paved, or gravel areas should be used if possible as a composting site.

*Compost utilization*—Finished compost is used in a variety of ways, but is primarily used as a fertilizer supplement and soil conditioner. Compost improves soil structure and soil fertility, but it generally contains too low a quantity of nitrogen to be considered the only source of crop nitrogen. Nutrients in finished compost will be slowly released over a period of years, thus minimizing the risk of nitrate leaching and high nutrient concentrations in surface runoff. For more information on land application of organic material, see AWMFH, chapter 11.

A good quality compost can result in a product that can be marketed to home gardeners, landscapers, vegetable farmers, garden centers, nursery/greenhouses, turf growers, golf courses, and ornamental crop producers. Generally, the marketing of compost from agricultural operations has not provided enough income to completely cover the cost of composting. If agricultural operations do not have sufficient land to spread the waste, marketing may still be an attractive alternative compared to hauling the waste to another location for land spreading. Often, compost operators generate additional income by charging municipalities and other local governments for composting urban

yard waste with the waste products of the agricultural operations.

Finished compost has also been successfully used as a bedding material for livestock. Because composting generates high temperatures that dry out and sterilize the compost, the finished product is generally acceptable as a clean, dry, bedding material.

*Compost mix design*—Composting of organic waste requires the mixing of an organic waste with amendment(s) or bulking agent(s) in the proper proportions to promote aerobic microbial activity and growth and to achieve optimum temperatures. The following must be provided in the initial compost mix and maintained during the composting process:

- a source of energy (carbon) and nutrients (primarily nitrogen)
- sufficient moisture
- sufficient oxygen for an aerobic environment
- a pH in the range of 6 to 8

The proper proportion of waste, amendments, and bulking agents is commonly called the recipe.

A composting amendment is any item added to the compost mixture that alters the moisture content, C:N ratio, or pH. Many materials are suitable for use as a composting amendment. Crop residue, leaves, grass, straw, hay, and peanut hulls are just some of the examples that may be available on the farm. Others, such as sawdust, wood chips, or shredded paper and cardboard, may be available inexpensively from outside sources. Table 10–8 shows typical C:N ratios of common composting amendments. The C:N ratio is highly variable, and local information or laboratory values should be used whenever possible.

A bulking agent is used primarily to improve the ability of the compost to be self-supporting (structure) and to increase porosity to allow internal air movement. Wood chips and shredded tires are examples of a bulking agent. Some bulking agents, such as large wood chips, may also alter the moisture content and C:N ratio, in which case they would be both a bulking agent and a compost amendment.

*Compost design parameters*—to determine the recipe, the characteristics of the waste and the amendments

**Table 10–8** Typical carbon to nitrogen ratios of common composting amendments

Material	C:N ratios	Material	C:N ratios
Alfalfa (broom stage)	20	Pine needles	225–1000
Alfalfa hay	12–18	Potato tops	25
Asparagus	70	Poultry manure (fresh)	6–10
Austrian pea straw	59	Poultry manure (henhouse litter)	12–18
Austrian peas (green manure)	18	Reeds	20–50
Bark	100–130	Residue of mushroom culture	40
Bell pepper	30	Rice straw	48–115
Breading crumbs	28	Rotted manure	20
Cantaloupe	20	Rye straw	60–350
Cardboard	200–500	Saw dust	300–723
Cattle manure (with straw)	25–30	Sawdust (beech)	100
Cattle manure (liquid)	8–13	Sawdust (fir)	230
Clover	12–23	Sawdust (old)	500
Clover (sweet and young)	12	Seaweed	19
Corn and sorghum stover	60–100	Shredded tires	95
Cucumber	20	Soil organic matter	10–24
Dairy manure	10–18	Soybean residues	20–40
Garden wastes	20–60	Straw	40–80
Grain rice	36	Sugar cane (trash)	50
Grass clippings	12–25	Timothy	80
Green leaves	30–60	Tomato leaves	13
Green rye	36	Tomatoes	25–30
Horse manure (peat litter)	30–60	Watermelon	20
Leaves (freshly fallen)	40–80	Water hyacinth	20–30
Newspaper	400–500	Weeds	19
Oat straw	48–83	Wheat straw	60–373
Paper	173	Wood (pine)	723
Pea vines (native)	29	Wood chips	100–441
Peat (brown or light)	30–50		
Pig manure	5–8		

\*For further information on C:N ratios, see AWMFH, chapter 4.

and bulking agents must be known. The characteristics that are the most important in determining the recipe are moisture content (wet basis), carbon content, nitrogen content, and the C:N ratio. If any two of the last three components are known, the remaining one can be calculated.

**Carbon to nitrogen (C:N) ratio**—the balance between carbon and nitrogen in the compost mixture is a critical factor for optimum microbial activity. After the organic waste and the compost ingredients are mixed together, microorganisms multiply rapidly and consume carbon as a food source and nutrients to metabolize and build proteins. The C:N ratio of the compost mix should be maintained for most compost operations between 25 and 40 to 1. If the C:N ratio is low, a loss of nitrogen generally occurs through rapid decomposition and volatilization of ammonia. If it is high, the composting time increases because the nitrogen becomes the limiting nutrient for growth.

**Moisture**—microorganisms need moisture to convert the carbon source to energy. Bacteria generally can tolerate a moisture content as low as 12 to 15 percent; however, with less than 40 percent moisture, the rate of decomposition is slow. At greater than 60 percent moisture, the process turns from one that is aerobic to one that is anaerobic. Anaerobic composting is less desirable because it decomposes more slowly and produces putrid odors. The finished product should result in a material that has a low moisture content.

**pH**—generally, pH is self-regulating and is not a concern when composting agricultural waste. Bacterial growth generally occurs within the range of pH 6.0 to 7.5, and fungi growth usually occurs within the range of 5.5 to 8.5. The pH varies throughout the compost mixture and during the various phases of the composting process. The pH in the compost mixture is difficult to regulate once decomposition is started. Optimum pH control can be accomplished by adding alkaline or acidic materials to the initial mixture.

*Compost mix design process*—the determination of the compost mix design (recipe) is normally an iterative process of adjusting the C:N ratio and moisture content by the addition of amendments. If the C:N ratio is out of the acceptable range, then amendments are added to adjust it. If this results in a high or low

moisture content, amendments are added to adjust the moisture content. The C:N ratio is again checked, and the process may be repeated. After a couple of iterations, the mixture is normally acceptable. Figure 10–38 is a mixture design process flow chart that outlines the iterative procedure necessary in determining the compost recipe.

The iterative process of the compost mix design can be summarized to a series of steps to determine the compost mix design. These steps follow the mixture design process flowchart shown in figure 10-38.

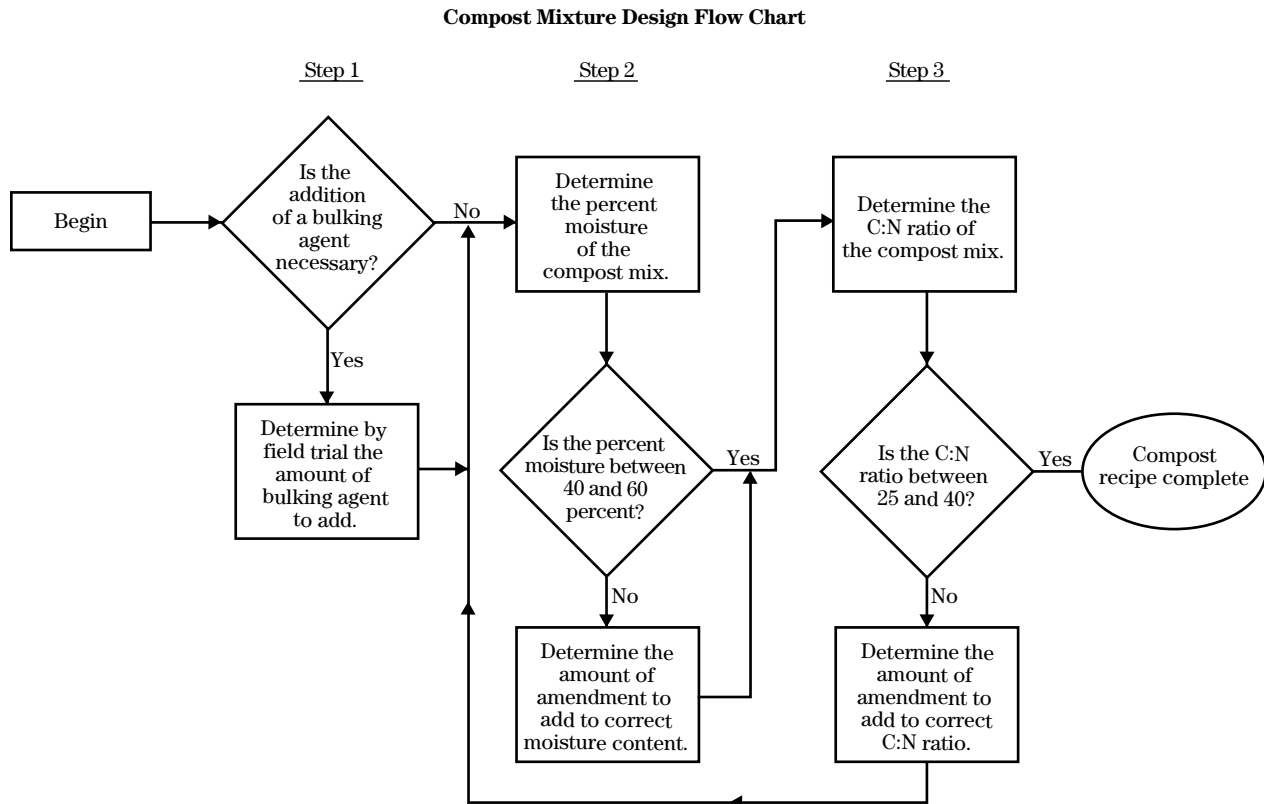
*Step 1* Determine the amount of bulking agent to add. The process normally begins with determining whether or not a bulking agent is needed. The addition of a bulking agent is necessary if the raw waste cannot support itself or if it does not have sufficient porosity to allow internal air movement. A small field trial is the best method to determine the amount of bulking agent required. To do this, a small amount of raw waste would be weighed and incremental quantities of bulking would be added and mixed until the mix has the structure and porosity desired. The wood chips, bark, and shredded tires are examples of bulking agents commonly used.

*Step 2* Calculate the moisture content of the compost mix. After the need for and quantity of bulking agent have been determined, the moisture content of the mixture or raw waste should be calculated. AWMFH, chapter 4 gives typical values for moisture content (wet basis) of excreted manure for various animals. Because water is often added as a result of spillage from waterers and in the cleaning processes, raw waste that is to be composted may have significantly higher moisture content than that of “as excreted” manure. If the amount of water added to the manure can be determined, the moisture content of the mix can be calculated using equation 10–11, ignoring the inappropriate terms.

In addition to extra water, feed spillage and bedding material can constitute a major part of the raw waste to be composted. The moisture content for each additive can be determined individually and used to determine the moisture content of the entire mix (equation 10–11). A sample of the raw waste (including the bedding, wasted feed, and water) can also be taken, weighed, dried, and weighed again to determine the



**Figure 10-38** Compost mixture design flowchart



moisture content of the mix. Using this procedure the moisture content can be calculated as follows:

$$M_i = \frac{\text{Wet weight} - \text{Dry weight}}{\text{Wet weight}} \times 100 \quad (\text{eq. 10-10})$$

where:

$M_i$  = percent moisture content (wet basis)

**Note:** To avoid confusion and repetition, the combination of “as excreted” manure, bedding, water, and bulking agent will be referred to as the “compost mix.”

The general equation for the moisture content of the compost mix is as follows. (The equation may contain variables that are not needed in every calculation.)

$$M_M = \frac{(W_w \times M_w) + (W_b \times M_b) + (W_a \times M_a) + H_2O}{W_m} \quad (\text{eq. 10-11})$$

where:

$M_m$  = percent moisture of the compost mixture (wet basis), eq. 10-10

$W_w$  = wet weight of waste (lb)

$M_w$  = percent moisture content of waste (wet basis), eq. 10-10

$W_b$  = wet weight of bulking agent (lb)

$M_b$  = percent moisture content of bulking agent (wet basis), eq. 10-10

$W_a$  = wet weight of amendment (lb)

$M_a$  = moisture content of amendment (wet basis)

$H_2O$  = weight of water added (lb) =  $G \times 8.36$ , where  $G$  = gallons of water

$W_m$  = weight of the compost mix (lb) including wet weight of waste, bulking agent, amendments, and added water

*Step 2 (continued)* Determine the amount of amendment to add, if any, to the compost mix that will result in final moisture content that is between 40 and 60 percent. If the moisture content of the compost mix is less than 40 percent, adding an amendment is necessary to raise the moisture content to an acceptable level. Water is the amendment that is generally added to raise the moisture content, but an amendment that has higher moisture content than the desired moisture

content of the compost mix is acceptable. It is generally best to begin the composting process when the moisture content is closer to 60 percent because the process of composting elevates the temperature and reduces moisture.

If the moisture content of the compost mix is above 60 percent, the addition of an amendment is necessary to lower the moisture content at or below 60 percent. Straw, sawdust, wood chips, and leaves are commonly used.

Equation 10-12 can be used to determine the amount of amendment to add to lower or raise the moisture content of the compost mix.

$$W_{aa} = \frac{W_{mb} \times (M_{mb} - M_d)}{(M_d - M_{aa})} \quad (\text{eq. 10-12})$$

where:

$W_{aa}$  = wet weight of amendment to be added

$W_{mb}$  = wet weight of mix before adding in amendment

$M_{mb}$  = percent moisture of mix before adding amendment

$M_d$  = desired percent moisture content of mix (wet bases)

$M_{aa}$  = moisture content of amendment added

**Note:** Equation 10-12 can be used for the addition of water by using:

$$M_{aa} = 100\% \text{ for water}$$

*Step 3* Calculate the C:N ratio. The C:N ratio for the compost mix is calculated from the C:N ratios of the waste, bulking agents, and amendments. Typical values for various selected agricultural wastes are shown in AWMFH, chapter 4. The C:N ratios for various waste products and amendments are also shown in table 10-9. The C:N ratios not reported in the literature can be estimated from the amount of fixed solids (amount of ash left after organic matter is burned off) or the volatile solids and the nitrogen content. Equations 10-13 and 10-14 are used to estimate the C:N ratio from the fixed or volatile solids.

$$\%C = \frac{100 - \%FS}{1.8} \quad (\text{eq. 10-13a})$$

$$W_c = \frac{VS}{1.8} \quad (\text{eq. 10-13b})$$

$$C:N = \frac{\%C}{\%N} = \frac{W_c}{W_n} \quad (\text{eq. 10-14})$$

where:

%C = percent carbon (dry basis)

%FS = percent fixed solids (dry basis)

$W_c$  = dry weight of carbon

VS = weight of volatile solids

C:N = carbon to nitrogen ratio

%N = percent total nitrogen (dry basis)

$W_n$  = dry weight of nitrogen

Typical values for nitrogen content of manure are reported in AWMFH, chapter 4, and typical values for percent nitrogen (dry basis) for many agricultural crops are reported in AWMFH chapter 6. The C:N ratio and nitrogen content of manure and of other amendments are highly variable. Using local values for C:N ratios and nitrogen or testing of the compost constituents is highly recommended. The general equation for estimating the C:N ratio of the compost mix is given by equation 10-15.

$$R_m = \frac{W_{cw} + W_{cb} + W_{ca}}{W_{nw} + W_{nb} + W_{na}} \quad (\text{eq. 10-15})$$

where:

$R_m$  = C:N ratio of compost mix

$W_{cw}$  = weight of carbon in waste (lb)

$W_{cb}$  = weight of carbon in bulking agent (lb)

$W_{ca}$  = weight of carbon in amendment (lb)

$W_{nw}$  = weight of nitrogen in waste (lb)

$W_{nb}$  = weight of nitrogen in bulking agent (lb)

$W_{na}$  = weight of nitrogen in amendment (lb)

The weight of carbon and nitrogen in each ingredient can be estimated using the following equations:

$$W_n = \%N \times W_{dry} \quad (\text{eq. 10-16a})$$

$$W_n = \frac{W_c}{C:N} \quad (\text{eq. 10-16b})$$

$$W_c = \%C \times W_{dry} \quad (\text{eq. 10-17a})$$

$$W_c = C:N \times W_n \quad (\text{eq. 10-17b})$$

where:

$W_{dry}$  = dry weight of material in question

The dry weight of material can be calculated using equation 10-18.

$$W_{dry} = W_{wet} \times \frac{100 - M_{wet}}{100} \quad \text{eq. (10-18)}$$

where:

$W_{wet}$  = wet weight of material in question

$M_{wet}$  = percent moisture content of material (wet basis)

*Step 3 (continued):* Determine the amount of amendment, if any, to add to the compost mix that will result in an initial C:N ratio that is between 25 and 40. If the C:N ratio calculated in step 3 is less than 25 or more than 40, the type and amount of amendment to add to the compost mix must be determined. For a compost mix that has a C:N ratio below 25, an amendment should be added that has a C:N ratio higher than the desired C:N ratio. For a compost mix that has a C:N ratio of more than 40, an amendment must be added that has a C:N ratio that is less than the desired C:N ratio.

Equation 10-19 or 10-20 can be used to calculate the weight of amendment to add to achieve a desired C:N ratio.

$$W_{aa} = \frac{W_{nm} \times (R_d - R_{mb}) \times 10,000}{N_{aa} \times (100 - M_{aa}) \times (R_{aa} - R_d)} \quad (\text{eq. 10-19})$$

$$W_{aa} = \frac{N_m W_{mb} \times (100 - M_{mb}) \times (R_d - R_{mb})}{N_{aa} \times (100 - M_{aa}) \times (R_{aa} - R_d)} \quad (\text{eq. 10-20})$$

where:

$W_{nm}$  = weight of nitrogen in compost mix (lb)

$R_d$  = desired C:N ratio

$R_{mb}$  = C:N ratio of the compost mix before adding amendment

$N_{aa}$  = percent nitrogen in amendment to be added (dry basis)

$R_{aa}$  = C:N ratio of compost amendment to be added

$N_m$  = percent nitrogen in compost mix (dry basis)  
 $M_{mb}$  = percent moisture of compost mix before adding amendment (wet basis), equation 10-10

$$W_{nd} = \frac{W_{cw} + W_{cb} + W_{ca}}{R_d} - (W_{nw} + W_{nb} + W_{na}) \quad (\text{eq. 10-21})$$

where:

$W_{nd}$  = dry weight of nitrogen to add to mix

For a compost mix that has a C:N ratio of more than 40, a carbonless amendment, such as fertilizer, can be added to lower the C:N ratio to within the acceptable range. In this special case, the following equation can be used to estimate the dry weight of nitrogen to add to the mix:

After the amount of an amendment to add has been determined to correct the C:N ratio, the design process then returns to step 2. If no change is necessary in steps 2 and 3, the compost mix design process is complete.

### Design example 10-7 Compost mix—bedding

A dairy farmer wishes to compost the waste generated from the herd in the barn. The waste is scraped daily from the barn and contains straw as a bedding material, but no extra water is added. Straw is the cheapest and most abundant source of a high C:N ratio amendment on the farm. The 100-cow Holstein herd is in the barn for an average of 6 hours. The average weight of a cow is 1,200 pounds with an average milk production of 75 pounds per day. Ten 60-pound bales of straw (chopped) are added daily for bedding. No bulking agent is necessary to improve the compost porosity or structure. Determine the design mix for the compost operation on a daily basis.

#### Given:

##### Wheat straw:

Moisture content = 15% (estimated)  
 C:N ratio = 80 (from table 10-9)  
 Percent N = 0.67% (from AWMFH, chapter 6)

##### Manure:

Number of cows = 100  
 Size of cows = 1,200 lb  
 Number of AU =  $100 \times 1,200/1,000 = 120$   
 Moisture content = 87% (from AWMFH, chapter 4, table 4-5(b))  
 Manure production = 108 lb/d/1,000 lb (from AWMFH, chapter 4, table 4-5(b))  
 Fraction in barn =  $6 \text{ h}/24 \text{ h} = 0.25$

Nitrogen production = 0.71 lb/1,000 lb/d (from AWMFH, chapter 4, table 4-5(b))

Volatile solids = 11 lb/1,000 lb/d (from AWMFH, chapter 4, table 4-5(b))

*Step 1* Bulking agent. A sample of the manure was stacked, and the manure appeared to have sufficient porosity to allow air movement and had the ability to support itself. Therefore, the addition of a bulking agent is not necessary.

*Step 2* Determine the moisture content of the waste. To determine the quantity of waste:

Manure in barn:

$$120 \text{ AU} \times 108 \text{ lb/d} \times 0.25 = 3,240 \text{ lb}$$

Weight of straw added daily:

$$10 \text{ bales} \times 60 \text{ lb} = 600 \text{ lb}$$

Weight of manure and straw ( $W_m$ ):

$$10 \text{ bales} \times 60 \text{ lb} = 600 \text{ lb}$$

Using equation 10-11, determine the moisture content of manure plus straw.

$$M_m = \frac{(3,240 \times 87) + (600 \times 15)}{(3,240 + 600)} \times 100 = 76\%$$

**Design example 10-7 Compost mix—bedding—Continued**

*Step 2 (continued)* Using equation 10-12, determine the amount of straw to add to bring the moisture content of the compost mix to 60 percent.

$$W_{aa} = \frac{3,840 \text{ lb} \times (76\% - 60\%)}{60\% - 15\%} = 1,365 \text{ lb}$$

New weight of compost mix:

$$W_m = 3,840 \text{ lb} + 1,365 = 5,205 \text{ lb}$$

*Step 3* Determine the C:N ratio of the compost mix. Determine the carbon and nitrogen content of the straw.

Total weight of straw:

$$600 + 1,365 = 1,965 \text{ lb}$$

Straw dry weight (equation 10-18):

$$1,965 \times \frac{(100 - 15)}{100} = 1,670 \text{ lb}$$

Weight of nitrogen in straw:

$$W_{na} = \frac{(0.67 \times 1,670 \text{ lb})}{100} = 11.2 \text{ lb}$$

Weight of carbon in straw (equation 10-17b):

$$W_{ca} = 11.2 \times 80 = 896 \text{ lb}$$

Determine the carbon and nitrogen content in manure.

Weight of volatile solids in barn:

$$120 \text{ AU} \times 11 \text{ lb/d/AU} \times 0.25 = 330 \text{ lb}$$

Weight of carbon in manure (using equation 10-13b):

$$W_{cw} = \frac{330 \text{ lb}}{1.8} = 183.3 \text{ lb}$$

Weight of nitrogen in manure:

$$W_{nw} = 120 \text{ AU} \times 0.71 \times 0.25 = 21.3 \text{ lb}$$

C:N ratio of manure:

$$\frac{183.3}{21.3} = 8.6$$

Determine C:N ratio of mixture (equation 10-15).

$$C : N = \frac{183.3 + 896}{21.3 + 11.2} = 33.2$$

A compost mix that has a C:N ratio of 33 is in the acceptable range, but for purposes of this example, continue step 3.

*Step 3 (continued)* Determine the type and amount of amendment to add to bring the C:N ratio of the mix to 30:1. To lower the C:N ratio, an amendment with a C:N ratio that is less than the desired final C:N ratio is necessary. Fresh manure that has a C:N ratio of 10.5 could be collected outside the barn, or fertilizer could be added to the mix. The farmer would like to see both alternatives.

Weight of nitrogen in current compost mix:

$$21.3 + 11.2 = 32.5 \text{ lb}$$

Dry weight of manure (equation 10-18):

$$3,240 \times \frac{(100 - 87)}{100} = 421 \text{ lb}$$

Percent nitrogen in manure:

$$\frac{21.3}{421} \times 100 = 5.1\%$$

Pounds of manure to add to bring mix to 30:1 (using equation 10-19):

$$W_{aa} = \frac{32.5 \times (30 - 33) \times 10,000}{5.1 \times (100 - 87) \times (8.6 - 30)} = 687 \text{ lb}$$

Pounds of nitrogen to add to bring compost mix to 30:1 (using equation 10-21)

$$W_{nd} = \frac{183.3 + 896}{30} - (21.3 + 11.2) = 3.5 \text{ lb}$$

**Design example 10–7 Compost mix—bedding—Continued**

Adding 3.5 pound of nitrogen is easier than adding 687 pounds of manure, so the obvious choice is to add nitrogen. If the farmer chooses to add nitrogen, no further calculations are necessary, because the moisture content of the mix is not changed with the addition of nitrogen. The design process would continue with step 2 if another type of amendment was added that resulted in a change in the moisture content of the manure.

The final compost mix consists of the following:

- Manure and bedding scraped from the barn: 3,840 lb
- Additional straw to correct moisture: 1,365 lb
- Nitrogen added to lower C:N ratio: 3.5 lb

**Design example 10–8 Compost mix—grass straw**

A grass seed farmer wishes to compost straw from rye grass seed harvest. A nearby dairy operation has agreed to furnish fresh manure for 2 weeks. Determine the compost mixture design.

**Given:****Rye grass straw:**

Amount	= 600 tons
Moisture content	= 7%
N per ton	= 6 lb
C:N ratio	= 100:1

**Manure:**

Number of cows	= 400
Size of cows	= 1,400 lb
Number of AU	= $400 \times 1,400/1,000=560$
Manure production	= 108 lb/d/1,000 lb
Nitrogen production	= 0.71 lb/d/1,000 lb
Volatile solids	= 11 lb/d/1,000 lb
Percent moisture	= 87%

*Step 1* No bulking agent is needed to improve structure or porosity.

*Step 2* Determine moisture content of rye grass straw and manure mixture.

Straw weight:

$$600 \text{ tons} \times 2,000 \text{ lb/ton} = 1,200,000 \text{ lb}$$

Manure weight:

$$560 \text{ AU} \times 108 \text{ lb/d/AU} \times 14 \text{ d} = 846,720 \text{ lb}$$

Moisture content ( $M_m$ ) of straw and manure (eq. 10–11):

$$\frac{(1,200,000 \times 7) + (846,720 \times 87)}{1,200,000 + 846,720} \times 100 = 40\%$$

The 40 percent moisture content of the mix is between 40 and 60 percent; for purposes of this exercise, add water to bring the moisture content to 50 percent.

*Step 2 (continued)* Using equation 10–12, determine the amount of water to add to bring the moisture content to 50 percent ( $W_{aa}$ ).

$$\frac{(1,200,000 + 846,720) \times (40 - 50)}{50 - 100} = 409,344 \text{ lb}$$

$$\frac{409,344}{8.33} = 49,141 \text{ gal}$$

*Step 3* Determine C:N ratio of the straw and manure mix. Determine the amount of carbon and nitrogen in the rye straw:

Nitrogen in straw:

$$W_{na} = 600 \text{ ton} \times 6 \text{ lb/ton} = 3,600 \text{ lb}$$

**Design example 10–8 Compost mix—grass straw—Continued**

Carbon in straw (eq. 10–17b):

$$W_{ca} = 100 \times 3,600 \text{ lb} = 360,000 \text{ lb}$$

Determine the amount of carbon and nitrogen in the manure.

Nitrogen in manure (use AWMFH, chapter 4 values for N):

$$560 \text{ AU} \times 0.71 \times 14 \text{ d} = 5,566 \text{ lb}$$

Assume a 20 percent loss of nitrogen in handling manure. Nitrogen left in manure:

$$W_{nw} = 5,566 \times \frac{100 - 20}{100} = 4,453 \text{ lb}$$

Weight of volatile solids in manure (use AWMFH, chapter 4 values):

$$560 \text{ AU} \times 11 \times 14 \text{ d} = 86,240 \text{ lb}$$

Carbon in manure (using eq. 10–13b):

$$W_{cw} = \frac{86,240 \text{ lb}}{1.8} = 47,911 \text{ lb}$$

C:N ratio of straw and manure mix (eq. 10–15):

$$\frac{360,000 + 47,911}{3,600 + 4,453} = 51 : 1$$

A C:N ratio of 51:1 is more than the maximum recommended of 40:1. The compost mix needs more nitrogen.

*Step 3 (continued)* Determine the amount of commercial nitrogen to add to the mix to bring the C:N ratio to 40:1.

Amount of nitrogen to add (eq. 10–21):

$$N_a = \frac{360,000 + 47,911}{40} - (3,600 + 4,453) \\ = 2,145 \text{ lb}$$

The final design mix is:

Rye grass straw	= 600 tons
Manure (14 days)	= 423.4 tons
Commercial nitrogen	= 2,145 lb

**Composting operational considerations**—The landowner/operator should be provided a written set of instructions as a part of the waste management plan. These instructions should detail the operation and maintenance requirements necessary for successful composting operation. They should include the compost mix design (recipe), method or schedule of turning or aerating, and instructions on monitoring the compost process and on long-term storage compost. The final use of the compost should be detailed in the Waste Utilization Plan.

**Composting time**—one of the primary composting considerations is the amount of time it takes to perform the composting operation. Composting time varies with C:N ratio, moisture content, climate, type of operation, management, and the types of wastes and amendments being composted. For a well managed windrow or static pile composting operation, the composting time during the summer months ranges from 14 days to a month. Sophisticated in-vessel methods may take as little as 7 days to complete the composting operation. In addition to the actual composting time, the amount of time necessary for compost curing and storage should be considered.

**Temperature**—consideration should be given to how the compost temperature is going to be monitored. The temperature probe should be long enough to penetrate a third of the distance from the outside of the pile to the center of mass. The compost temperature should be monitored on a daily basis if possible. The temperature is an indicator of the level of microbial activity within the compost. Failure to achieve the desired temperatures may result in the incomplete destruction of pathogens and weed seeds and can cause fly and odor problems.

Initially, the compost mass is at ambient temperature; however, as the microorganisms multiply, the temperature rises rapidly.

The composting process is commonly grouped into three phases based on the prominent type of bacteria present in the compost mix. Figure 10-39 illustrates the relationship between time, temperature, and compost phase. If the temperature is less than 50 degrees Fahrenheit, the compost is said to be in the psychrophillic stage. If it is in the range of 50 to 105 degrees Fahrenheit, the compost is in the mesophillic stage. If the compost temperature exceeds 105 degrees Fahr-

heit, the compost is in the thermophillic stage. For complete pathogen destruction, the compost temperature must exceed 135 degrees Fahrenheit.

The compost temperature will decline if moisture or oxygen is insufficient or if the food source is exhausted. In compost methods where turning is the method of aerating, a temperature rhythm often develops with the turning of the compost pile (fig. 10-40).

**Moisture**—the moisture content of the compost mixture should be monitored periodically during the process. Low or high moisture content can slow or stop the compost process. High moisture content generally results in the process turning anaerobic and foul odors developing. High temperature drives off significant amounts of moisture, and the compost mix may become too dry, resulting in a need to add water.

**Odor**—the odor given off by the composting operation is a good indicator of how the compost operation is proceeding. Foul odors may mean that the process has turned from aerobic to anaerobic. Anaerobic conditions are the result of insufficient oxygen in the compost. This may be caused by excessive moisture in the compost or the need for turning or aerating of the compost.

**Compost process steps**—The composting operation generally follows these steps (fig. 10-41):

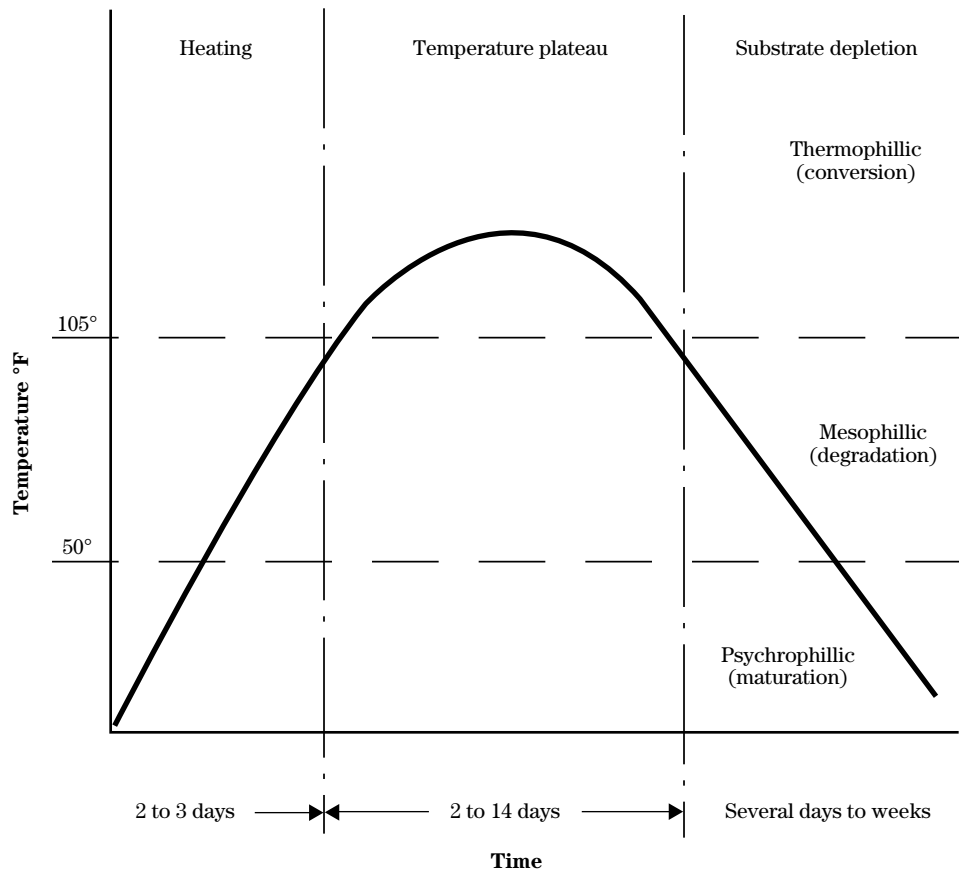
*Step 1* Preconditioning of materials (as needed). Grinding or shredding of the raw material may be necessary to increase the exposed surface area of the compost mixture to enhance decomposition by microorganisms.

*Step 2* Mixing of the waste with a bulking agent or amendment. A typical agricultural composting operation involves mixing the raw waste with a bulking agent or amendment, or both, according to a prescribed mix or design. The prescribed mix should detail the quantities of raw waste, amendments, and bulking agents to be mixed. The mixing operation is generally done with a front-end loader on a tractor, but other more sophisticated methods can be used.

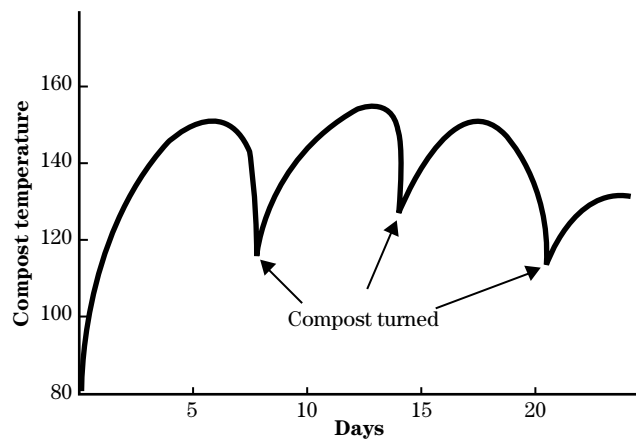
*Step 3* Aeration by forced air or mechanical turning. Once the materials are mixed, the composting process begins. Bacteria begin to multiply and consume carbon and free oxygen. To sustain



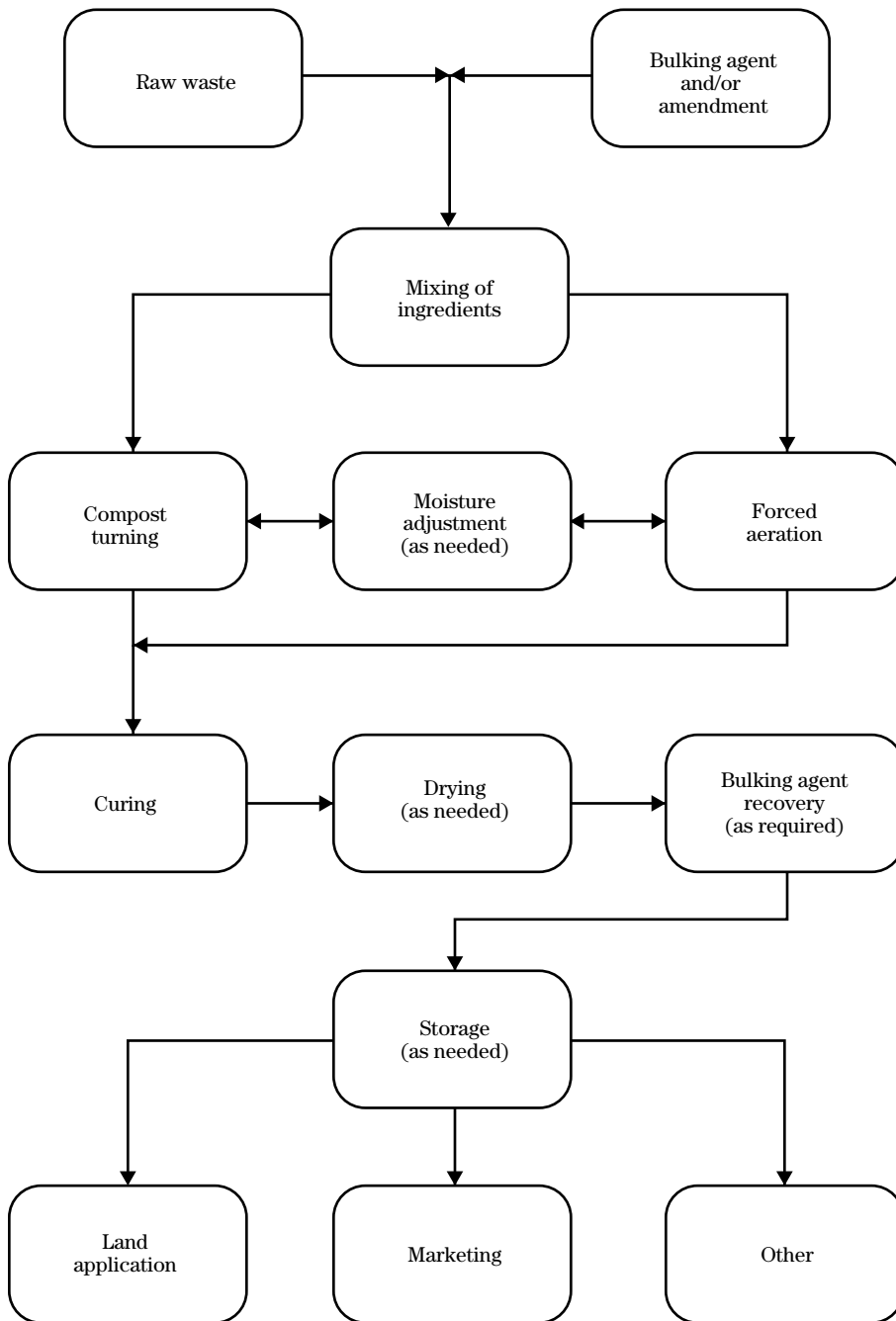
**Figure 10-39** Composting temperature



**Figure 10-40** Typical temperature rhythm of windrow method



**Figure 10-41** Agricultural composting process flow



microbial activity, air must be added to the mix to re-supply the oxygen to the compost pile. Air can be added by simply remixing or turning the compost pile. With more sophisticated methods, such as an aerated static pile, air is forced or sucked through the compost mix using a blower. The pounds of air per pound of volatile matter per day generally range from 5 to 9. Given in percentage, the optimum oxygen concentration of the compost mixture ranges from 5 to 15 percent, by volume. An increase of oxygen beyond 15 percent generally results in a decrease in temperature because of greater air flow. Low oxygen concentrations generally result in anaerobic conditions and slow processing times. Inadequate aeration results in anaerobic conditions and increased odors. Odor is an excellent indicator of when to turn and aerate a compost pile.

*Step 4.* Moisture adjustment (as needed). Water should be added with caution because too much moisture can easily be added. A compost mix that has excessive moisture problems does not compost properly, appears soggy and compacted, and is not loose and friable. Leachate from the compost mixture is another sign of excessive moisture conditions.

*Step 5.* Curing (optional). Once the compost operation is completed, it can be applied directly to the field or stored and allowed to cure for a period of months. During the curing process, the compost temperature returns to ambient conditions and the biological activity slows down. During the curing phase, the compost nutrients are further stabilized. The typical curing time ranges from 30 to 90 days, depending on the type of raw material and end use.

*Step 6.* Drying (optional). Further drying of the compost to reduce weight may be necessary if the finished compost is to be marketed, hauled long distances, or used as bedding. Drying can be accomplished by spreading the compost out in warm, dry weather or under a roofed structure until a sufficient quantity of moisture evaporates.

*Step 7.* Bulking agent recovery (as needed or required). If such bulking agents as shredded tires or large wood chips are used in the compost mixture, they can be recovered from the finished compost by screening. The recovered bulking agents are then reused in the next compost mix.

*Step 8.* Storage (as needed). Finished compost may need to be stored for a period of time during frozen or snow-covered conditions or until the compost product can be marketed. If possible, finished compost should be covered to prevent leaching or runoff.

### **(7) Vegetated treatment areas**

A vegetated treatment area is a wide, flat area of vegetation used for removing suspended solids and nutrients from concentrated livestock area runoff and other liquid by-products of agricultural operations. The vegetated areas are designed with adequate length and limited flow velocities to promote filtration, deposition, infiltration, absorption, adsorption, decomposition, and volatilization of contaminants. Consideration must be given to hydraulic as well as contaminant loading.

Vegetated treatment areas rely on nutrient uptake to remove nitrates and other nutrients that are in solution, since these constituents are very mobile in water. Soils are used to infiltrate the liquid fraction. Provision for rest periods between loadings is recommended. In cases where a large volume of runoff is expected, settling basins are needed above the treatment area. Clean water must be diverted from the treatment area. Installation and maintenance are critical.

The total treatment area should be designed to match crop nutrient uptake from the runoff or volume of water runoff with soil infiltration capacity. Typically, the nutrient balance approach is the limiting design sizing method. Uniform flow across the vegetated slope is required, possibly requiring shaping and other methods for distributing flow, in addition to field maintenance to limit erosion and channeling.

NRCS Conservation Practice Standard 635, Vegetated Treatment Area, gives more detailed planning considerations and design criteria. Also, see AWMFH, 651.0605(c) for additional information. If State or local government has restrictions on the use of vegetated treatment areas, the requirements must be met before design and construction. This is especially true if the outflow from the treatment area will flow into a stream or waterway. Unless permitted by State regulations, agricultural runoff treatment by a vegetated treatment area is not sufficient to allow discharge to surface water.

**(8) Constructed wetlands**

A constructed wetland is a shallow treatment system that uses aquatic vegetation and microorganisms to reduce nutrients, organic matter, and suspended solids in runoff from agricultural operations. Constructed wetlands treatment systems can utilize subsurface flow, surface flow, or a combination of these two processes. A natural or constructed subsurface barrier is used to control seepage. The design and operating parameters include hydraulic retention, cell depth and size, substrate composition, and recycling requirements.

Subsurface flow systems utilize submerged flow through a permeable medium, reducing odor problems. Examples are root-zone systems, rock-reed-filters, and vegetated submerged bed systems. Typical media includes soil, sand, and gravel or crushed rock.

Surface flow systems are similar to natural wetlands, utilizing shallow water flowing over a soil surface. Vegetation and aerobic bacteria provide nutrient reduction. Surface flow systems should be planned and designed according to NRCS Conservation Practice Standard 656, Constructed Wetland, which gives more detailed planning considerations and design criteria. Also, see NEH 637, Environmental Engineering, Chapter 3, Constructed Wetland (NEH637.0305) for additional information.

Reciprocating flow systems (RECIP) are designed to create alternating surface and subsurface flow between paired wetland cells. By using fill and drain, the environment alternates between aerobic and anaerobic conditions, allowing oxidation and reduction to occur. Organic decomposition occurs through nitrification/denitrification, phosphorus removal, sulfate reduction, and limited methanogenesis.

If State or local government has restrictions on the use of constructed wetlands, the requirements must be met before design and construction. This is especially true if the outflow from the wetland will flow into a stream or waterway. Unless permitted by State regulations, agricultural runoff treatment by a constructed wetland is not sufficient to allow discharge to surface water.

**(9) Human waste management**

If at all possible, human waste should be treated in municipal facilities designed to provide proper treat-

ment. However, in many rural areas, this is not possible.

Septic tank systems designed for specific soil conditions are typically used for treating human waste in areas not served by municipal treatment facilities.

Most home sewage systems rely on anaerobic decomposition in septic tanks with the resulting effluent being discharged into a leaching field. Some conditions, such as a high water table, require that the septic system be constructed above ground in mounds. Human waste is not to be stored or processed in animal waste management facilities because of the potential for disease transmission.

Landowners should contact local health authorities for design requirements and permit information before installing treatment systems for human waste. NRCS does not design human waste management systems, but some States have extension specialists or environmental engineers that can assist in designing suitable systems.

## 651.1006 Utilization

Utilization is a function in a manure management system employed for a beneficial purpose. The typical method is to apply the manure to the land as a source of nutrients for plant growth and of organic matter to improve soil tilth and water holding capacity and to help control erosion. The vast majority of manure produced in the United States is applied to cropland, pasture, and hayland. Manure properly managed and applied at the appropriate rates and times can significantly reduce the amount of commercial fertilizer needed for crop production.

Manure and other by-products of agricultural operations can also be used directly as fuels for energy production or converted to generate biogas. In addition, by drying or composting, the material can be used for bedding or potting material. Solid and liquid separation increase available alternatives for utilization.

### (a) Nutrient management

Manure should be applied at rates where the nutrient requirements of the crop to be grown are met. Concentration of nutrients in the manure should be known, and records on manure application rates should be maintained.

Between the time of manure production and the time of application, nutrient concentrations can vary widely because of storage, dilution, volatilization, settling, drying, or treatment. To accurately use manure, representative samples of the material to be land applied should be analyzed for nutrient content. Before application rates can be computed, the soil in the fields where manure will be applied should be analyzed and nutrient recommendations obtained. This information should indicate the amount of nutrients to be applied for a given crop yield.

Scheduling land application of wastes is critical. Several factors must be considered:

- amount of available manure storage
- major agronomic activities such as planting and harvesting

- weather and soil conditions
- availability of land and equipment
- stage of crop growth

A schedule of manure application should be prepared in advance. It should consider the most likely periods when application is not possible. This can help in determining the amount of storage, equipment, and labor needed to make application at desired times. NRCS Conservation Practice Standard 590, Nutrient Management, gives more detailed planning considerations and design criteria.

### (b) Land application equipment

Manure is land applied using a variety of equipment. The kind of equipment used depends on the TS concentration of the material. If the manure handles as a solid, a box spreader or flail spreader is used. Solids spreaders are used for manure from solid manure structures and for the settled solids in sediment basins.

Slurry manures are applied using tank wagons or flail spreaders. Some tank wagons can be used to inject the material directly into the soil. Slurry spreaders are typically used for manure that is stored in above or belowground storage structures, earthen storage structures, and sometimes lagoons.

Manure that has a TS concentration of less than 5 percent can be applied using tank wagons, or it can be irrigated using large diameter nozzles. Irrigation is used primarily for land application of liquids from lagoons, storage ponds, and tanks. Irrigation systems must be designed on a hydraulic loading rate, as well as on nutrient utilization.

Custom hauling and application of manure are becoming popular in some locations. This method of utilization reduces the amount of specialized equipment needed by the owner/operator. NRCS Conservation Practice Standard 634, Waste Transfer, gives more detailed planning considerations and design criteria.

## (c) Land application of municipal sludge

Municipalities in the United States treat wastewater biologically using anaerobic or aerobic processes. These processes generate sludge that has agronomic value as a nutrient source and soil amendment. Land application of sludge is currently recognized as acceptable technology; however, strict regulations and practices must be followed.

## (d) Bioenergy production

Bioenergy can be produced from commonly used materials on the farm such as crops, animal excretions, and by-products from food processing. The conversion process into solid, liquid, or gaseous fuels can be separated into three broad categories: thermochemical, biochemical, and agrochemical processes. Thermochemical processes include direct combustion, liquefaction, gasification, and pyrolysis. Biochemical processes include hydrolysis-fermentation and anaerobic digestion. Agrochemical processes include the crushing of seed crops and the extraction of the oil for fuel, such as biodiesel and heating oil. The products from these processes include such items as biogas, methanol, ethanol and biodiesel oils.

### (1) Anaerobic digestion

An anaerobic digester used for biogas production is considered a utilization function component because the manure is being managed for use even though further management of the digester effluent is required. Anaerobic digestion is the process of storing liquid manure in an air-tight vessel to be decomposed by microbes into methane, carbon dioxide, hydrogen sulfide, and water vapor as gaseous by-products. This biological conversion process has a number of advantages. Fresh manure has high moisture content (about 80%), making it unsuitable for most thermochemical processes; the high content of lignin makes it unattractive for fermentation to ethanol or other products. Additionally, the process offers the potential for onsite energy production and odor reduction.

Biogas, the product of anaerobic digestion, is typically made up of 55 to 65 percent methane ( $\text{CH}_4$ ), 35 to 45 percent carbon dioxide ( $\text{CO}_2$ ), and traces of ammonia ( $\text{NH}_3$ ) and hydrogen sulfide ( $\text{H}_2\text{S}$ ). Although biogas can range from approximately 55 to 80 percent  $\text{CH}_4$ , biogas generated from animal manures is typically around 65

percent  $\text{CH}_4$ . The amount of  $\text{CH}_4$  generated depends on the livestock type, frequency of waste collection, waste handling method, and climate. Pure methane is a highly combustible gas that has an approximate heating value of 994 British thermal units (BTU) per cubic foot. Biogas can be burned in boilers to produce hot water, in engines to power electrical generators, and in absorption coolers to produce refrigeration.

The most frequent problem with anaerobic digestion systems is related to the economical use of the biogas. The biogas production rate from a biologically stable anaerobic digester is reasonably constant; however, most on-farm energy use rates vary substantially. Because compression and storage of biogas is expensive, economical use of biogas as an on-farm energy source requires that farm use must closely match the energy production from the anaerobic digester. Additionally, environmental conditions can directly affect biogas production efficiency.

Because of the presence of hydrogen sulfide, biogas may have an odor similar to that of rotten eggs. Hydrogen sulfide mixed with water vapor can form sulfuric acid, which is highly corrosive. It can be removed from biogas by passing the gas through a column of iron-impregnated wood chips or adding air to the digester headspace area. Water vapor can be removed by condensers or condensate traps. Carbon dioxide can be removed by passing biogas through lime water under high pressure.

Biogas can be used to heat the slurry manure in the digester. From 25 to 50 percent of the biogas is required to maintain a working digester temperature of 95 degrees Fahrenheit, depending on the climate and the amount of insulation used. Belowground digesters require less insulation than those aboveground. Engines can burn biogas directly from digesters; however, removal of hydrogen sulfide and water vapor is recommended.

If digested solids are separated from digester effluent and dried, they make an excellent bedding material. A brief period of composting may be necessary before it is used.

Anaerobic digestion in itself is not a pollution control practice. Digester effluent must be managed similarly to undigested manure by storing in storage ponds or treating in lagoons. Initial start-up of a digester is

critical. The digester should be partly filled with water (50–75% full) and brought to temperature using an auxiliary heater. Feeding of the digester with manure should increase over a period of 3 to 6 weeks starting with a feeding rate of about 25 percent of full feed (normal operation).

Biogas production rates can be measured using specially designed corrosion resistant gas meters. These rates and carbon dioxide levels are good indicators of digester health during start-up. Several simple tests can be used in the field to determine carbon dioxide.

The potential amount of biogas produced from animal manure can be theoretically or empirically estimated. At a minimum, laboratory testing of animal manure to determine the chemical oxygen demand (COD) and TS contents should be conducted when considering anaerobic digestion as a treatment alternative. This information can be used to estimate potential biogas production and to evaluate applicable anaerobic digester configurations. The volume of biogas generated from the anaerobic digestion of manure can be theoretically predicted based on the COD of the manure and the COD to CH<sub>4</sub> conversion efficiency. If the COD is not available, VS content can be used to estimate potential methane production. NRCS Conservation Practice Standard 366, Anaerobic Digester, gives more detailed planning considerations and design criteria.

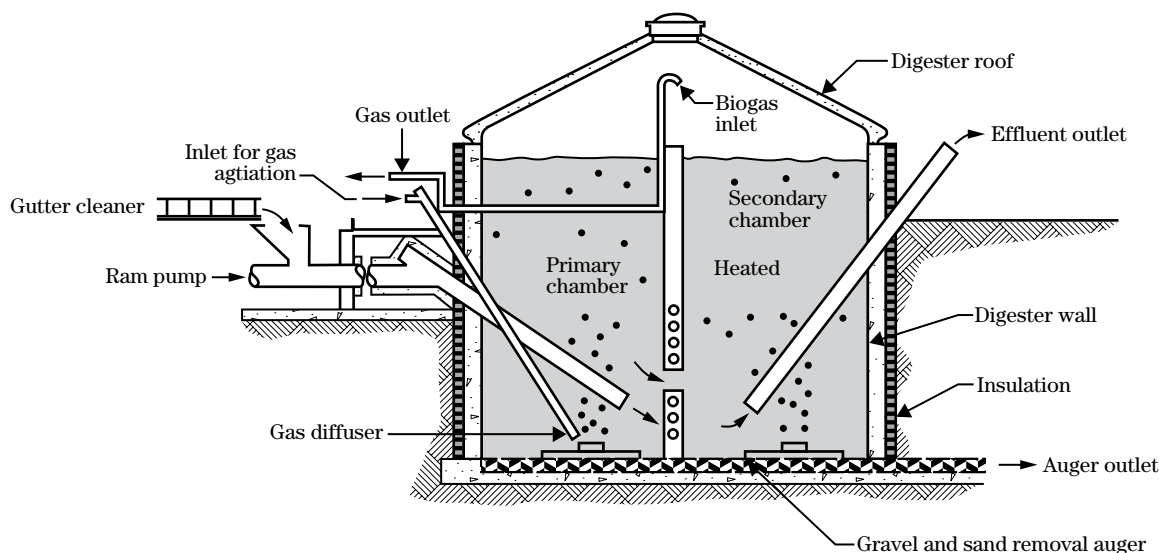
**Design procedure**—Because of the safety issues and economic and operational complexities involved, NRCS assistance on biogas production is generally limited to planning and feasibility. The information presented here is intended for that type of assistance. Interested farmers and ranchers should be advised to obtain other assistance in the detailed design of the facility.

The guidelines presented here are based on digestion of manure in the mesophilic temperature range (about 95 °F) and may be subject to change as a result of additional research and experience. They provide a basis for considering biogas production facilities based on current knowledge as part of a waste management system.

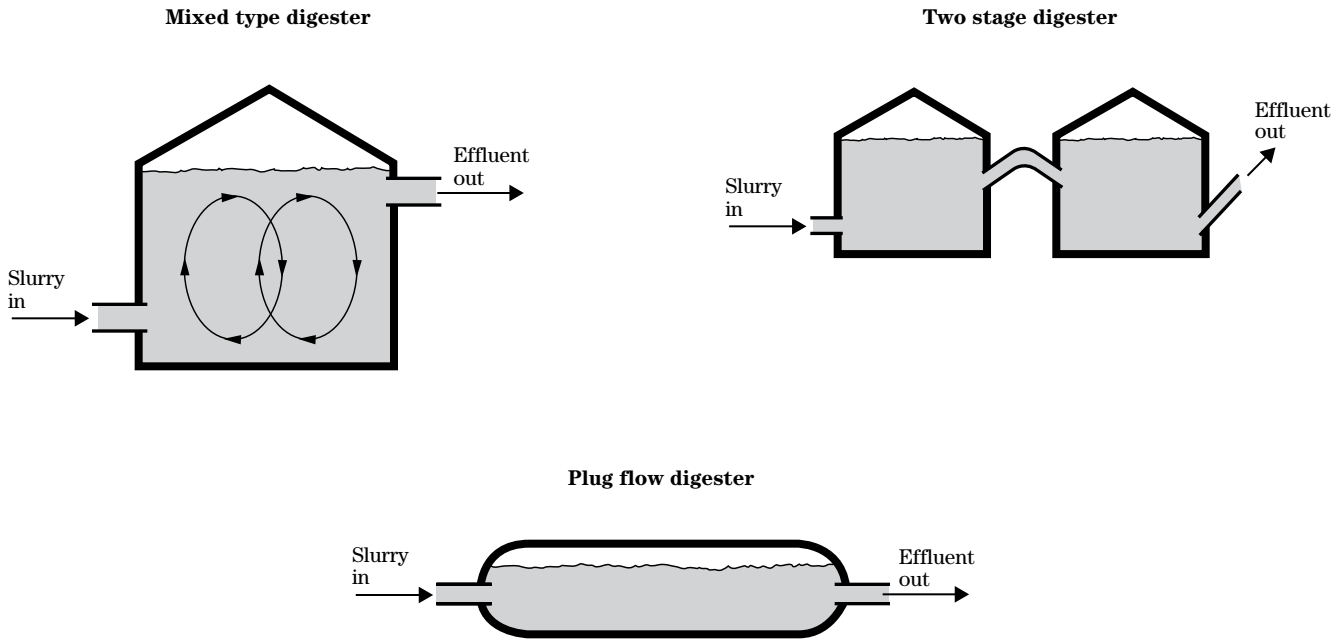
Several digester types are used (figs. 10–42, 10–43, 10–44). The mixed tank is a concrete or metal cylindrical vessel constructed aboveground. If the manure is highly liquid (low TS), the digester must be periodically mixed to get complete digestion. This can be done mechanically using a mechanical mixer, recirculating digestion liquid, or pumping biogas into the bottom sludge to remix the contents of the digester.

Another digester, known as the plug flow, is used for relatively thick manure (12–14% TS), such as dairy manure. The manure is introduced at one end and theo-

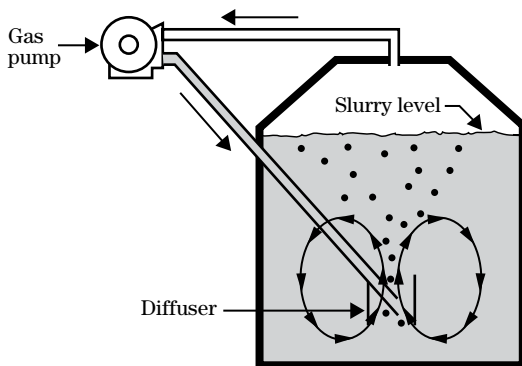
**Figure 10–42** Two-stage, mixed tank anaerobic digester



**Figure 10-43** Typical anaerobic digester types



**Figure 10-44** Gas agitation in an anaerobic digester





retically moves as a plug to the other end. However, if the TS content of the influent manure is too low, the manure will channel, the actual retention time will be reduced, and the biogas yield will diminish.

Biogas production is dependent upon the animal species, type of digester used, storage and handling losses, collection methods, and feed management. For any digester, the influent must be managed for consistency in frequency of feeding. For this to happen, the rations fed and manure management must be consistent. Some manure requires preprocessing before it enters the digester. For example, poultry manure must be diluted to about 6 percent TS to allow grit to settle before the manure is pumped into the digester. Grit material is very difficult to remove from digesters. All digesters must be periodically cleaned. The frequency of cleaning can vary from 1 to 4 years.

*Step 1* Determine manure production. Manure production can be based on the tables in AWMFH, chapter 4 or on reliable local data. The following data will be needed:

Volume of manure produced	= —ft <sup>3</sup> /d
Wet weight of manure produce	= —lb/d
Total solids (TS)	= —lb/d
Volatile solids (VS)	= —lb/d
Percent solids (TS/wet weight)	= —%

Fresh manure is desirable for digestion. Characteristics of beef feedlot manure must be determined for each operation.

*Step 2* Establish TS concentration for digester feed. TS concentrations considered desirable as input to the digester can range from about 6 to 12 percent. The following are guidelines:

Dairy manure	10 to 12%
Confined beef manure	10 to 12%
Beef feedlot manure (after settling grit)	8 to 10%
Swine manure	8 to 10%
Chicken manure	7 to 9%

These percentages may need to be adjusted to eliminate scum formation and promote natural mixing by the gas produced within the mass. If scum forms, a small increase in percent solids may be desirable. This increase may be limited

by pumping characteristics and should seldom go above 12 percent solids.

*Step 3* Determine effective digester volume. A hydraulic detention time of 20 days is suggested. This time appears to be about optimum for efficient biogas production. The daily digester inflow in cubic feet per day can be determined using equation 10-24.

$$DMI = \frac{TMTS \times 100}{DDSFC \times 62.4} \quad (\text{eq. 10-24})$$

where:

DMI = daily manure inflow, ft<sup>3</sup>

TMTS = total manure total solids production, ft<sup>3</sup>/d

DDSFC = desired digester input total solids concentration, %

The necessary digester volume in cubic feet can be determined using equation 10-25.

$$DEV = DMI \times 20 \quad (\text{eq. 10-25})$$

where:

DEV = digester effective volume, ft<sup>3</sup>

20 = recommended detention time, d

*Step 4* Select digester dimensions. Optimum dimensions of the liquid part of the digester volume have not been established. The digester should be longer than it is wide to allow raw manure to enter one end and digested slurry to be withdrawn at the other. An effectively operating digester has much mixing by heat convection and gas bubbles.

Sufficient depth should be provided to preclude excessive delay at start-up because of the oxygen interchange at the surface. A combination of width equal to about two times the depth and length equal to about four times the depth is a realistic approach. Other proportions of width and length should work equally well. For the purpose of discussion assume:

$$H = \left( \frac{DEV}{8} \right)^{0.33}$$

$$WI = 2 \times H$$

$$L = 4 \times H$$

where:

H = height, ft

WI = width, ft

L = length, ft

Dimensions should be adjusted to round numbers to fit the site and provide economical construction.

**Step 5** Estimate potential biogas production. Biogas production is dependent on manure decomposition within the digester. Biogas production from manure may vary significantly from the estimates that follow. Animals fed a high roughage ration produce less biogas than those fed a high concentrate ration. Also, solids separation can significantly affect biogas production. Finally, volatile solids reduction may vary from 30 to 60 percent, depending upon management and animal characteristics.

Estimated VS reductions are:

Dairy	35%
Beef	40%
Swine	50%
Poultry	55%

Estimated daily biogas production rates are:

Dairy	10 ft <sup>3</sup> /lb VS destroyed
Beef	10 ft <sup>3</sup> /lb VS destroyed
Swine	12 ft <sup>3</sup> /lb VS destroyed
Poultry	11 ft <sup>3</sup> /lb VS destroyed

Biogas production per day is estimated by multiplying the percent volatile solids reduction times the estimated daily biogas production rate times the daily volatile solids input. Biogas production in cubic feet per day would be:

Dairy	$3.5 \times$ daily VS input
Beef	$4 \times$ daily VS input
Swine	$6 \times$ daily VS input
Poultry	$6 \times$ daily VS input

Initial start-up of a digester requires a period of time for anaerobic bacteria to become acclimated and multiply to the level required for optimum methane production. If available, sludge from a municipal anaerobic digester or another anaerobic manure digester can be introduced to speedup the start-up process. The digester contents must be maintained at about 95 degrees Fahrenheit for continuous and uniform biogas production. Hot

water tubes within the digester can serve this purpose.

**Other considerations**—Biogas is difficult to store because it cannot be compressed at normal pressures and temperatures. Storage pressures above 250 pounds per square inch are rarely used. Because of these reasons, biogas usage is generally planned to match production and, thus, eliminate the need for storage.

The most common use of biogas is the production of electricity using an engine-generator set. The thermal conversion efficiency is about 25 percent for this type of equipment. The remainder of the energy is lost as heat. Heat exchangers can be used to capture as much as 50 percent of the initial thermal energy of the biogas from the engine exhaust gases and the engine cooling water. This captured heat can sometimes be used onsite for heating. Some of it must be used to maintain the digester temperature.

Effluent from anaerobic digesters has essentially the same amount of nutrients as the influent. Some of the organic nitrogen will be converted to ammonia, making it more plant available, but more susceptible to volatilization unless the liquid is injected. Only a little volume is lost by processing the manure through an anaerobic digester. For manure requiring dilution before digestion, the amount of liquid to be stored and handled actually increases as compared to the original amount of manure.

### Design example 10–9 Biogas digester

Mr. Joe Sims of Hamburg, Pennsylvania, has requested assistance on development of a manure management system for his 100 Guernsey milk cows that weigh an average of 1,200 pounds. He has requested that an alternative be developed that includes an anaerobic digester to produce methane gas. Determine the approximate size of the digester using worksheet 10A–5.

## Worksheet 10A-5—Anaerobic digester design

Decisionmaker: <u>Joe Sims</u>		Date: <u>6/13/89</u>
Site: <u>Hamburg, PA</u>		
<b>Animal units</b>		
1. Animal type <u>Milkers</u>	3. Number of animals (N) <u>100</u>	
2. Animal weight, lbs (W) <u>1200</u>	4. Animal units, $AU = \frac{W \times N}{1000} =$ <u>120</u>	
<b>Manure volume</b>		
5. Daily volume of daily manure production per AU, $\text{ft}^3/\text{AU}/\text{day}$ (DVM) = <u>1.7</u>	7. Total daily manure production volume, $\text{ft}^3/\text{day}$ (TMP) <u>204</u>	
6. Total volume of daily manure production for animal type, $\text{ft}^3/\text{day}$ MPD = AU x DVM <u>204</u>		
<b>Manure total solids</b>		
8. Daily manure total solids production, $\text{lbs}/\text{AU}/\text{day}$ (MTS) = <u>14</u>	10. Total manure total solids production, $\text{lbs}/\text{day}$ (TMTS) = <u>1680</u>	
9. Daily manure total solids production for animal type, $\text{lb}/\text{day}$ MTSD = MTS x AU = <u>1680</u>		
<b>Manure volatile solids</b>		
11. Daily manure volatile solids production per AU, $\text{lbs}/\text{AU}/\text{day}$ (MVS) = <u>11</u>		
12. Daily manure volatile solids production for animal type per day, $\text{lbs}/\text{day}$ MVSD = AU x MVS = <u>1320</u>		
13. Total manure volatile solids production, $\text{lbs}/\text{day}$ (TMVS) <u>1320</u>		
<b>Percent solids</b>	<b>Digester feed solid concentration</b>	
14. Percent solids, % (PS) $PS = \frac{\text{TMTS} \times 100}{\text{TMP} \times 62.4} = \frac{(1680) \times 100}{(204) \times 62.4} =$ <u>13.2</u>	15. Desired digester feed solids concentration, % (DDFSC) = <u>12.0</u>	
<b>Daily manure inflow</b>	<b>Digester effective volume</b>	
16. Daily manure inflow, $\text{ft}^3$ $DMI = \frac{\text{TMTS} \times 100}{\text{DDFSC} \times 62.4} = \frac{(1680) \times 100}{(12) \times 62.4} =$ <u>224.4</u>	17. Digester effective volume, $\text{ft}^3$ $DEV = DMI \times 20 = (224.4) \times 20 =$ <u>4,488</u>	
<b>Digester dimensions</b>	19. Digest width, ft $WI = 2 \times H = 2 \times (8.08) =$ <u>16.2</u>	
18. Digester depth, ft $H = \left( \frac{\text{DEV}}{8} \right)^{0.33} = \left( \frac{4,488}{8} \right)^{0.33} =$ <u>8.08</u>	20. Digest length, ft $L = 4 \times H = 4 \times (8.08) =$ <u>32.3</u>	
<b>Estimated energy production</b>		
21. Biogas per unit (VS), $\text{ft}^3/\text{lb}$ (BUVS) = <u>3.5</u>	23. Estimated energy production $\text{BTU}/\text{day}$ $EEP = \text{EBP} \times 600 = (4620) \times (600) =$ <u>2,772,000</u>	
22. Estimated biogas production $\text{ft}^3/\text{day}^3$ $\text{EBP} = \text{BUVS} \times \text{TMVS} = (3.5) \times (1320) =$ <u>4,620</u>		

## (2) Thermochemical conversion

Anaerobic digestion may have a thermal efficiency as low as 30 percent, since only the methane portion of biogas is available for energy conversion. Thermochemical energy conversion efficiency may be double that of anaerobic digestion, since all hydrocarbon compounds are converted to fuel. Thermochemical conversion uses pressure or heat to decompress biomass to produce energy. Examples include incineration (burning with excess air to produce heat), pyrolysis (thermal treatment in little to no air, producing pyrolysis oil and biogas), gasification (thermal treatment using high temperatures in little to no air to produce biogas), and liquefaction (thermal conversion of a slurry to produce oils and char). Some processes may require air emission permits, depending upon local regulations.

### (i) Incineration

Incineration is the direct combustion of dry manure (15–20% moisture) to produce heat without generating intermediate fuel gases, liquids, or solids. Temperatures range between 1500–3000 degrees Fahrenheit. Combustion requires the simultaneous processes of heat and mass transport, pyrolysis, gasification, ignition, and burning, with fluid flow. Usually excess air is supplied to ensure maximum fuel conversion. Combustion produces heat, carbon dioxide, water vapor, and ash, with the heat typically used for steam production. However, incomplete combustion can produce pollutants like carbon monoxide, particulate matter, and volatile organic compounds (VOCs). Additionally, nitrogen and sulfur compounds in the dry manure and other reactions caused by the high combustion temperatures can lead to emissions of oxides of nitrogen and sulfur ( $\text{NO}_x$  and  $\text{SO}_x$ ).

### (ii) Pyrolysis

Pyrolysis is a low oxygen process that operates at temperatures between 390 and 1100 degrees Fahrenheit to produce liquids, gases, and solids from manure. Pyrolysis oils can be used as boiler fuel or refined similar to crude oil. Solids can be used similar to charcoal. Combustion of pyrolysis liquids and gases result in the same end products as produced by direct combustion of solids, but with improved pollution control, conversion efficiencies, and easier fuel storage and handling. Minimal oxygen requirements reduce the formation of pollutants. The process can also be optimized for the production of liquids or gases, depending upon job

requirements. Part of the energy budget must be used to dry the manure to 15 to 20 percent moisture.

### (iii) Gasification

Gasification is a form of pyrolysis to optimize gas production at temperatures between 1100 and 1800 degrees Fahrenheit. The gas (syngas) is primarily carbon monoxide, hydrogen, methane, and some light weight hydrocarbons. By-products of gasification include liquids (tars, oils, and other condensates) and solids (char and ash). Syngas can be used in internal combustion engines or used to produce methanol. Combustion of syngas result in the same end products as produced by direct combustion of solids, but with improved pollution control, conversion efficiencies, and easier fuel storage and handling. Internal combustion engines can use their own pollution control systems to minimize by-products.

### (iv) Liquefaction

Liquefaction is the conversion of manure slurry to hydrocarbon oils and tars using pressures up to 200 atmospheres and temperatures between 390 and 900 degrees Fahrenheit. Typical processing time is measured in minutes. Products of liquefaction can be converted to hydrocarbon fuels and chemicals similar to those produced from petroleum. Pyrolysis and direct liquefaction differ in the operating conditions and end products. Additionally, drying of manure is not a limiting factor in liquefaction.

## 651.1007 Mortality management

Every livestock and poultry facility experiences loss of animals by death. Mortality management involves hygienic, environmental, and aesthetical considerations to deal with carcasses in a timely, safe, and nonoffensive manner. Although many methods of mortality management are available, local and State regulations will often restrict the locally available options. Mortality management facilities should be planned and designed in accordance with NRCS Practice Standard 316, Animal Mortality Facility.

Utilization of the nutrients and energy contained in the dead animals should be given first consideration. Rendering and composting of dead animals both result in by-products that can be recycled. Gasification can provide energy to reduce the energy requirements of combustion. If utilization is not viable, consideration can be given to disposal by incineration or burial.

### (a) Rendering and freezing

Rendering provides a method to recycle the nutrients in the carcass, usually as an ingredient in pet food. Because of the need to minimize decomposition, the carcass needs to be transported to a rendering facility within 24 hours. Decomposition can be minimized by preservation using freezing or fermentation. Freezing requires large custom-built or commercial freezer boxes to preserve dead animals until they can be picked up for delivery to the rendering plant. Although expensive, freezing minimizes pathogen transfer between farms. Fermentation requires grinding the carcass and adding carbohydrates for preservation by fermentation.

### (b) Incineration

Burning carcasses at elevated temperatures provides an effective method of waste disposal. Ashes generated from a properly operating incinerator do not pose a pollution problem or an insect vector. However, costs of equipment and fuel in addition to potential odor and air pollution, are significant design challenges.

### (c) Gasification

Using carcasses to generate energy and mineral ash are an attractive alternative. A burner heats a combustion chamber at temperatures between 1100 and 1800 degrees Fahrenheit. Carcasses are placed in the combustion chamber with low to no oxygen. The generated gases go from the combustion chamber to the gasification chamber as fuel to the gasification unit. The resulting ash is sterile, with bio-available minerals such as phosphorous, calcium, and magnesium. Also, the system may have sufficient capacity for multiple units to be used for catastrophic losses. However, air emission permits may be required, depending upon local regulations.

### (d) Sanitary landfill

Sanitary landfills are disposal sites for solid waste. They are designed, constructed, and operated to be environmentally safe. Although one of the simplest methods of disposal, landfill sites often restrict the items that can be placed in the landfill.

### (e) Burial

A common method for onsite dead animal disposal is burial for anaerobic decomposition. The burial sites need to be at least 150 feet downgradient from any ground water supply source. Sites that have highly permeable soils, fractured or cavernous bedrock, and a seasonal high water table are not suitable and should be avoided. In no case should the bottom of the burial pit be closer than 5 feet from the ground water table. Surface water should be diverted from the pit.

### (f) Composting

The disposal of dead animals is a major environmental concern. Composting can be an economical and environmentally acceptable method of handling dead animals. This process produces little odor and destroys harmful pathogens. Composting of dead poultry is the most common process. The process does not apply equally well to other animals. Several universities have developed criteria for successfully composting whole large animals. For more information on composting animal mortality, refer to the NRCS National Engineer-

ing Handbook, Part 637, Environmental Engineering, Chapter 2, Composting.

Composting of dead animals should be considered when:

- a preferred use, such as rendering, is not available
- the mortality rate as a result of normal animal production is predictable
- sufficient land is available for nutrient utilization
- State or local regulations permit dead animal composting
- other disposal methods are not permitted or desired
- marketing of finished compost is feasible

### (1) Special planning considerations

Because composting of dead animals is similar in many ways to other methods of composting, the same siting and planning considerations apply. These considerations will not be repeated here. Composting of dead animals does, however, have unique problems that require special attention.

Many States and localities regulate the disposal of dead animals. A construction permit may be required before installation of the facility begins, and an operating permit may be necessary to operate the facility. The animal producer is responsible for procuring all necessary permits to install and operate the facility.

The size of the animals to be composted should be considered when planning a compost facility. Larger animals require additional equipment, labor, and handling to cut the animals into smaller pieces to facilitate rapid composting. In lieu of dissecting carcasses, longer composting times can be used.

Dead animal composting facilities should be roofed to prevent rainfall from interfering with the compost operation. Dead animal composting must reach a temperature in excess of 130 degrees Fahrenheit for a minimum of 5 days to destroy pathogens. The addition of rainfall can elevate the moisture content and result in a compost mix that is anaerobic. Anaerobic composting takes much longer and creates odor problems.

### (2) Sizing mortality composting facilities

A typical mortality composting facility consists of two stages. The first stage, also called the primary composter, is made up of equally sized bins in which the dead animals and amendments are initially added and allowed to compost. The mixture is moved from the first stage to the second stage, or secondary digester, when the compost temperature begins to decline. The second stage can also consist of a number of bins, but it is most often one bin or concrete area or alley that allows compost to be stacked with a volume equal to or greater than the sum of the first stage bins.

The design volume for each stage should be based on peak disposal requirements for the animal operation. The peak disposal period normally occurs when the animals are close to their market weight. The volume for each stage is calculated by multiplying the weight of dead animals at maturity times a volume factor. The volume factor (VF) can vary depending upon typical animal weight, type of composter, local conditions, and experiences. Table 10-9 can be used to estimate VF.

Equation 10-22 can be used to calculate the volume for each stage in the compost facility.

$$\text{Vol} = B \times \frac{M}{T} \times W \times \frac{\text{VF}}{100} \quad (\text{eq. 10-22})$$

where:

Vol = volume required for each stage (ft<sup>3</sup>)

B = number of animals

M = percent normal mortality of animals for the entire life cycle expressed as percent

T = number of days for animal to reach market weight (d)

W = market weight of animals (lb)

VF = volume factor

**Table 10-9** Volume factor if nitrogen source, such as poultry litter or manure, is used

Carcass size (lb)	Volume factor
0-4	1.0-2.5
4-10	3.0
10-25	5.0
25-300	10.0
300-750	14.0
750-1,400	20.0

**Note:** M/T is used to estimate the percentage of dead animals to be composted at maturity. Other estimators or field experience may be more accurate.

The number of bins required for the first and second stages can be estimated to the nearest whole number by dividing the total volume required by the volume of each bin (eq. 10–23).

$$\# \text{ Bins} = \frac{\text{Total 1st stage volume (ft}^3\text{)}}{\text{Volume of single bin (ft}^3\text{)}} \quad \text{eq. (10–23)}$$

Bins are typically 5 feet high, 5 feet deep, and 8 feet across the front. The width across the front should be sized to accommodate the equipment used to load and unload the facility. To prevent spontaneous combustion and to allow for ease of monitoring, a bin height of no more than 6 feet is recommended. The depth should also be sized to accommodate the equipment used.

A high volume to surface area ratio is important to insulate the compost and allow the internal temperature to rise. The bin height and depth should be no less than half the width. Shallow bins are easier to unload and load; therefore, the bin depth should be no more than the width. Figure 10–45 is an example of a dead animal composting bin.

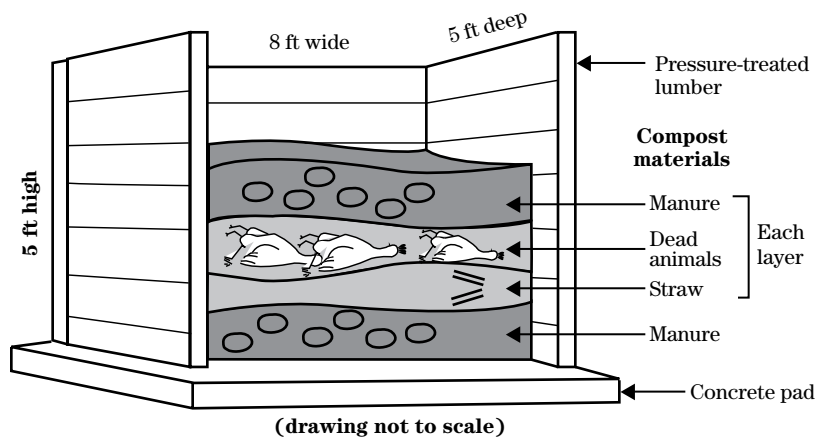
Mortality rates vary considerably because of climate and among varieties, species, and types of operation.

Information provided by the animal producer/operator should be used whenever possible. Table 10–10 gives typical mortality rates, growth cycle, and market weights for animals and poultry.

*Mix requirements*—rapid composting of dead animals occurs when the C:N ratio of the compost mix is maintained between 10 and 20. This is considerably lower than what is normally recommended for other types of composting. Much of the nitrogen in the dead animal mass is not exposed on the surface; therefore, a lower C:N ratio is necessary to ensure rapid composting with elevated temperatures. If the dead animals are shredded or ground up, a higher C:N ratio of 25:1 would be more appropriate. The initial compost mix should have a C:N ratio that is between 13 and 15. As composting proceeds, nitrogen, carbon, and moisture are lost. Once composting is complete, the C:N ratio should be between 20 and 25. A C:N ratio of more than 30 in the initial compost mixture is not recommended because excessive composting time and failure to achieve the temperature necessary to destroy pathogens may result.

The moisture content of the initial compost mixture should be between 45 and 55 percent, by weight, to facilitate rapid decomposition. An initial moisture content of more than 60 percent would be excessively moist and would retard the compost process. The most common problem in dead animal composting is the addition of too much water. Depending on the mass of dead animals and the moisture content of the

**Figure 10–45** Dead animal composting bin



amendments, water may not need to be added to the initial mix. Because water is relatively dense compared to the compost mix, the addition of a little water can raise the moisture content of the mix considerably. Even though water may not need to be added to the initial mix, it is advisable to have a source of water available at the compost site for temperature control.

Composting of dead animals should remain aerobic at all times throughout the process. Anaerobic conditions result in putrid odors and may not achieve temperatures necessary to destroy pathogens. Foul odor during the compost process indicates that the compost process has turned anaerobic and that corrective action is needed. These actions will be addressed later. To prevent the compost process from going anaerobic,

the initial mix should have enough porosity to allow air movement into and out of the compost mix. This can be accomplished by layering dead animals and amendments in the mix. For example, a dead poultry compost mix would be layered with straw, dead birds, and manure or waste cake from the poultry houses. Layers of such high porosity material as straw, wood chips, peanut hulls, and bark allow lateral movement of air in the compost mix. Figure 10–46 is an example of commonly recommended layering of manure, straw, and dead poultry.

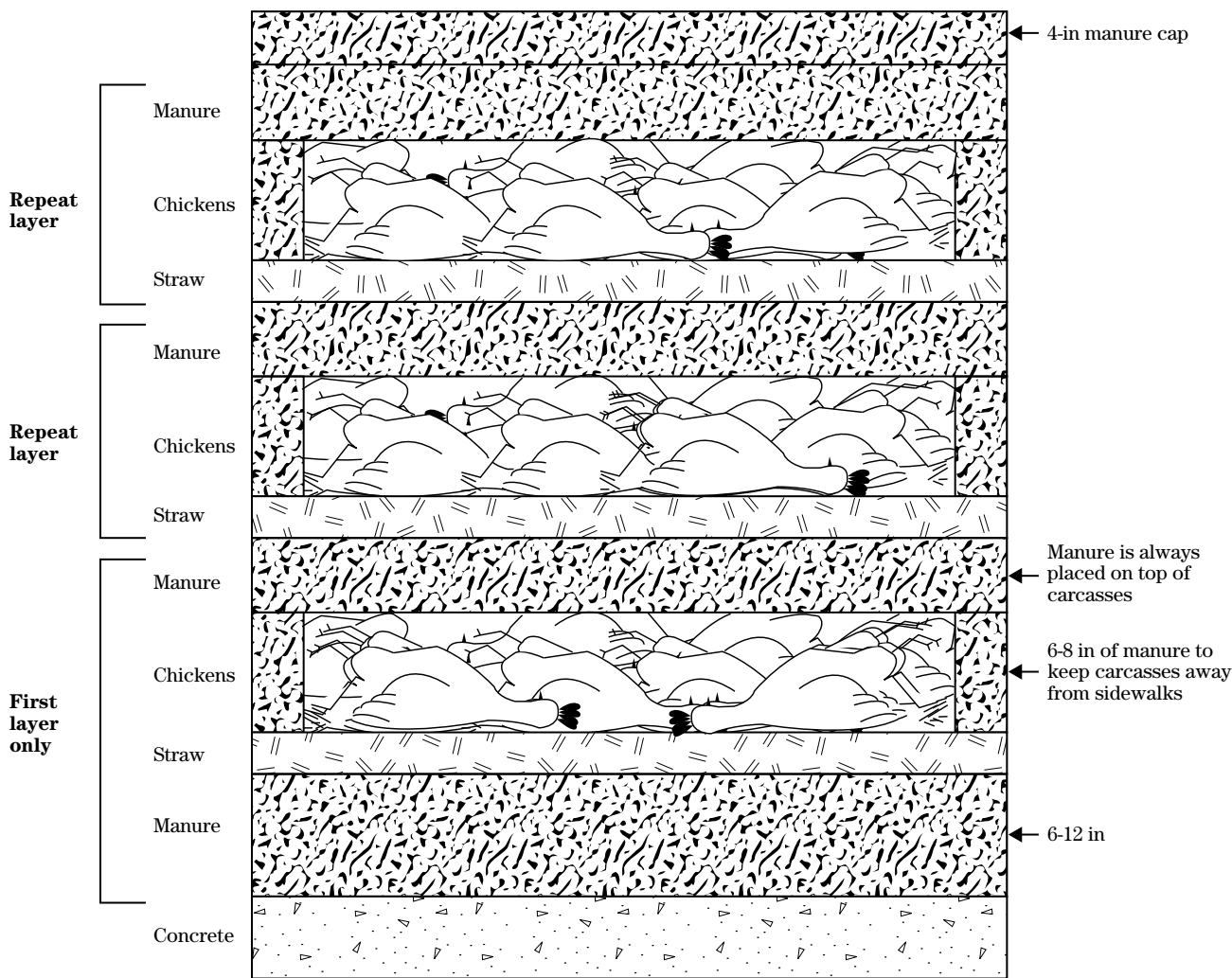
Table 10–11 is a typical recipe for composting dead birds. The ingredients are presented by volume as well as weight.

**Table 10–10** Animal mortality rates

Animal type Poultry type	Mortality rate (%)	Growth cycle (d)	Cycles (per year)	Market weight (lb)
Broiler	4.5–5.0	42–49	5.5–6.0	4.2
Roaster				
female	3	42	4	4.0
male	8	70	4	7.5
Laying hen	14	440	0.9	4.5
Breeding hen	10–12	440	0.9	7–8
Breeder male	20–25	300	1.1	10–12
Turkey female	5–6	95	3	14
Turkey male	9	112	3	24
Swine, farrow—prewean	11	20		10
Swine, farrow—nursery to 60 lb	2.6	47		35
Swine, grower/finisher	6	119	2.5	210
Swine, sow and gilt <250 lb	2.5			
Swine, sow and gilt 250–500 lb	3			
Swine, sow and gilt >500 lb	3.7			
Beef cattle (>500 lb)	1.2			
Beef calf	3.3			
Dairy cattle (>500 lb)	2.8			
Dairy calf	6.4			
Horse <20 years old	1.2			
Horse >20 years old	10.2			
Horse, foal (less than 30 days)	4.9			
Sheep, all causes	6.2			
Sheep, nonpredator	3.9			
Lamb, all causes	10.1			
Lamb, nonpredator	5.5			



**Figure 10-46** Recommended layering for dead bird composting



**Table 10-11** Broiler compost mix

Ingredient	Volume (parts)	Weight (parts)
Straw	1.0	0.1
Broiler	2.0	1.0
Manure	2.0	1.5
Water*	0.5	0.75

\* More or less water may be necessary depending on the moisture content of the straw and manure.

Research and evaluation on composting dead animals other than poultry is limited. The differences between livestock and poultry as related to composting are insignificant except for the size of the animal to be composted and the density of skeletal material. Large birds, such as turkeys, have been successfully composted. If large animals are to be composted, they should be cut into no larger than 15-pound pieces and be cut in a manner to maximize surface exposure. Large animal composting is a promising technology, but it is not well documented. Caution is advised.

*Operational considerations*—efficient and rapid composting requires careful control of the C:N ratio, percent moisture and aerobic conditions, and the internal temperature of the compost mix. A deficiency in any of these three areas retards and possibly inhibits the composting process achieving temperatures too low for pathogen destruction. Careful planning and monitoring is required to ensure that the process is proceeding as expected.

The landowner/operator should be provided a written set of instructions as a part of the waste management plan that detail the operation and maintenance requirements necessary for successful dead animal composting. The instructions should include compost mix design (recipe), method or schedule of when to unload the primary digester (first stage) and load the secondary digester (second stage), methods to monitor the compost process, and information on long-term compost storage. The final utilization of the compost should be detailed in the waste utilization plan.

Temperature is an important gauge of the progress of the composting operation. After initial loading into the first stage, the compost temperature should peak between 130 and 140 degrees Fahrenheit in 5 to 7 days. The same is true for when the compost is moved and stacked in the second stage. Elevated temperatures are necessary to destroy the fly larvae, pathogenic bacteria, and viruses. The two-stage process maximizes the destruction of these elements.

When the compost is initially loaded into the compost bin, the internal temperature begins to rise as a result of bacterial activity. Maximum internal temperatures within the first stage should exceed 130 degrees Fahrenheit within a few days. Although internal compost temperatures rise to a level necessary for the destruction of pathogenic organisms and fly larvae, the tem-

peratures near the edge of the compost pile will not be sufficient to destroy these elements. The edge of the compost stack in the first stage may remain an incubation area for fly larvae and allow the survival of the more heat-resistant pathogens.

Removing the compost from the first stage and restacking in the second stage mixes and aerates the compost. The compost that was on the edge of the compost pile is mixed with the internal compost material, and subsequently is exposed to temperatures in excess of 130 degrees Fahrenheit in the second stage stack.

The internal temperature of the compost in the first and second stages should be monitored on a daily basis. The compost should be moved from the first stage to the second stage when the internal temperature of the first stage compost begins to decline. This generally occurs after 5 to 7 days.

If internal temperatures fail to exceed 130 degrees Fahrenheit in the first or second stages of the composting process, the compost material should immediately be incorporated if land applied or remixed and composted a second time.

Excessively high temperatures are also a danger in dead animal composting because spontaneous combustion of the compost material can occur when the compost temperature exceeds 170 degrees Fahrenheit. If the temperature exceeds 170 degrees Fahrenheit, the compost should be removed from the bin and spread out in a uniform layer no more than 6 inches deep. Water should be used, if necessary, to further cool the compost. Once the temperature has fallen to a safe level, the compost can be restacked. Adding moisture to the compost should retard the biological growth and reduce the temperature. Excessive applications of water stop the process and can cause anaerobic conditions to develop. The compost mix should be rehydrated to a moisture content of 55 to 65 percent, by weight, to reduce excessive temperatures.

Anaerobic conditions may develop if the initial porosity of the compost mix is too low, excessive amounts of water are added to the mix, or the C:N ratio is excessively low. Odor generally is a good indicator of anaerobic conditions. If foul odors develop, the reason for the odor problem must be identified before corrective action can be taken. Anaerobic conditions may

be the result of any one or a combination of excessive moisture, low porosity, or low C:N ratio.

## **(h) Emergency mortality management**

Catastrophic mortality can occur for many reasons like fire, heat stress, inadequate ventilation, poisoning, diseases, and bioterrorism. An effective disease control and carcass disposal strategy is critical. Any animal feeding operation should have an emergency action plan for catastrophic mortality. Planning for a catastrophic event should include a study of local regulations specifying acceptable methods for disposal. Planning and preparation should also include identification of sites for disposal and obtaining insurance to cover the resultant costs.

### **(1) Biosecurity concerns**

Carcass disposal is a major concern for biosecurity. Both disease control and environmental impacts are major considerations. Should a major disease outbreak occur, disposal of slaughtered animals requires large investments of time and space in an isolated environment. Transportation options are usually very limited. Current disease control policies usually require isolation and immediate mass slaughter to control a disease outbreak. Vaccination in conjunction with later slaughter can provide additional time and reduce immediate disposal requirements, but create tradeoffs between carcass disposal and disease control.

### **(2) Available options**

Alternatives for carcass disposal for catastrophic mortality traditionally use normal mortality management facilities. However, these facilities may have limited availability and limited capacity.

Burial of catastrophic mortality shall be timed to minimize the effects of bloating during early stages of the decay process. When permitted by State law, mortality shall remain uncovered or lightly covered until bloating has subsided. Some topsoil should be stockpiled to re-grade the disposal site after the ground has settled and the decay process is largely completed.

Where composting is used for catastrophic mortality disposal, the operation and maintenance plan should identify the most likely compost medium, possible compost recipes, operational information, and readily available equipment.

Incineration and gasification will combust the carcass, kill pathogens, and produce ash high in phosphorus and magnesium. However, fuel costs and availability of facilities are limiting factors.

## 651.1008 Safety

Much of this material was taken from the publication *Safety and Liquid Manure Handling* (White and Young 1980).

Safety must be a primary consideration in managing animal waste. It must be considered during planning and designing of waste management system components, as well as during the actual operation of handling wastes. The operator must be made aware of safety aspects of any waste management system components under consideration. Accidents involving waste management may be the result of:

- poor design or construction
- lack of knowledge or training about components and their characteristics
- poor judgment, carelessness, or lack of maintenance
- lack of adequate safety devices, such as shields, guard rails, fences, or warning signs

The potential for an accident with waste management components is always present. However, accidents do not have to happen if components are properly designed, constructed, and maintained and if all persons involved with the components are adequately trained and supervised.

First aid equipment should be near storage units and lagoons. A special, easily accessible area should be provided for storing the equipment. The area should be inspected periodically to ensure that all equipment is available and in proper working condition. The telephone numbers of the local fire department and/or rescue squad should be posted near the safety equipment and near all telephones.

### (a) Confined areas

Manure gases can accumulate when manure is stored in environments that do not have adequate ventilation, such as underground covered waste storage tanks. These gases can reach toxic concentrations and displace oxygen. The four main gases are ammonia (NH<sub>3</sub>), carbon dioxide (CO<sub>2</sub>), hydrogen sulfide (H<sub>2</sub>S),

and methane (CH<sub>4</sub>). The gases produced under anaerobic conditions and the requirements for safety because of these deadly gases are described in AWMFH, chapter 3. Because of the importance of safety considerations, the following repeats and elaborates on these safety requirements.

Ammonia is an irritant at concentrations below 20 parts per million. At higher levels it can be an asphyxiant.

Carbon dioxide is released from liquid or slurry manure. The rate of release is increased with agitation of the manure. High concentrations of carbon dioxide can cause headaches and drowsiness and even death by asphyxiation.

Hydrogen sulfide is the most dangerous of the manure gases and can cause discomfort, headaches, nausea, and dizziness. These symptoms become severe at concentrations of 800 parts per million for exposures over 30 minutes. Hydrogen sulfide concentrations above 800 parts per million can lead to unconsciousness and death through paralysis of the respiratory system.

Methane is also an asphyxiant; however, its most dangerous characteristic is that it is explosive.

Several rules should be followed when dealing with manure stored in poorly ventilated environments:

- Safety equipment can include air packs and face masks, nylon line with snap buckles, safety harness, first-aid kits, flotation devices, safety signs, and hazardous atmosphere testing kits or monitors. All family members and employees should be trained in first-aid, CPR techniques, and safety procedures and policies. The following material discusses specific safety considerations.
- Do not enter a manure pit unless absolutely necessary and only then if the pit is first ventilated, air is supplied to a mask or a self-contained breathing apparatus, a safety harness and attached rope is put on, and there are two people standing by.
- If at all feasible, construct lids for manure pits or tanks and keep access covers in place. If an open, ground-level pit or tank is necessary, put a fence around it and post "Keep Out" signs.

- Do not attempt without assistance to rescue humans or livestock that have fallen into a manure storage structure or reception pit.
- Move all the animals out of the building, if possible when agitating manure stored beneath that building. If the animals cannot be removed, the following steps should be taken:
  - If the building is mechanically ventilated, turn fans on full capacity when beginning to agitate, even in the winter.
  - If the building is naturally ventilated, do not agitate unless there is a brisk breeze blowing. The animals should be watched when agitation begins, and at the first sign of trouble, the pump should be turned off. The critical area of the building is where the pumped manure breaks the liquid surface in the pit. If an animal drops over because of asphyxiation, do not try to rescue it. Turn off the pump, and allow time for the gases to escape before entering the building.
- Do not smoke, weld, or use an open flame in confined, poorly ventilated areas where methane can accumulate.
- Keep electric motors, fixtures, and wiring near manure storage structures in good condition.

### (b) Aboveground tanks

Aboveground tanks can be dangerous if access is not restricted. Uncontrolled access can lead to injury or death from falls from ladders and to death from drowning if someone falls into the storage tank. The following rules should be enforced:

- Permanent ladders on the outside of aboveground tanks should have entry guards locked in place or the ladder should be terminated above the reach of individuals.
- A ladder must never be left standing against an aboveground tank.

### (c) Lagoons, ponds, and liquid storage structures

Lagoons, ponds, and liquid storage structures present the potential for drowning of animals and humans if

access is not restricted. Floating crusts can appear capable of supporting a person's weight and provide a false sense of security. Tractors and equipment can fall or slide into storage ponds or lagoons if they are operated too close to them. The following rules should be obeyed:

- Rails should be built along all walkways or ramps of open manure storage structures.
- Fence around storage ponds and lagoons, and post signs reading "Caution Manure Storage (or Lagoon)." The fence keeps livestock and children away from the structure. Additional precautions include a minimum of one lifesaving station equipped with a reaching pole and a ring buoy on a line.
- Place a barrier strong enough to stop a slow-moving tractor on all push-off platforms or ramps.
- If manure storage is outside the livestock building, use a water trap or other device to prevent gases in the storage structure from entering the building, especially during agitation.

### (d) Equipment

All equipment associated with waste management, such as spreaders, pumps, conveyors, and tractors, can be dangerous if improperly maintained or operated. Operators should be thoroughly familiar with the operator's manual for each piece of equipment. Equipment should be inspected frequently and serviced as required. All guards and safety shields must be kept in place on pumps, around pump hoppers, and on manure spreaders, tank wagons, and power units.

### (e) Fences

Fences are an important component in some agricultural waste management systems. They are planned and designed in accordance with Conservation Practice Standard 382, Fencing. As they apply to agricultural waste management, fences are used to:

- Confine livestock so that manure can be more efficiently collected.
- Exclude livestock from surface water to prevent direct contamination.

- Provide the necessary distance between the fence and surface water to be protected for the interception of lot runoff in a channel, basin, or other collection or storage facility located above the lot.
- Reduce the lot area and thus reduce the volume of lot runoff to be collected or stored.
- Exclude livestock from hazardous areas such as waste storage ponds.
- Allow management of livestock for waste utilization purposes.
- Protect vegetative filters from degradation by livestock.

## 651.1009 References

- Alpert, J.E. 1987. Composting process and operations. University of Massachusetts. On-farm Composting Conference. E&A Environmental Consultants. Sloughton, MA.
- Alpert, J.E. 1987. Windrow and Static Pile Composting. University of Massachusetts, On-farm Composting Conference. E & A Environmental Consultants. Sloughton, MA.
- American Society of Agricultural Engineers (ASAE). 1982. Solid and liquid manure storages. Engineering Practice 393. Agricultural Engineering Yearbook. St. Joseph, MI. pp 303–305.
- Barker, J.C. 1986. Course notes from agricultural waste management class, North Carolina State University. Raleigh, NC
- Barth, C.L. 1985a. The rational design standard for anaerobic livestock lagoons. Proceedings of the Fifth International Symposium on Agricultural Wastes. ASAE. St. Joseph, MI. pp. 638–646.
- Barth, C.L. 1985b. Livestock waste characterization—a new approach. Proceedings of the Fifth International Symposium on Agricultural Wastes. ASAE. St. Joseph, MI. pp 286–294.
- Bartlett, A. Windrow composting of poultry and horse manure with hay. White Oak Farm. Belchertown, MA.
- Barton, T.L., and R.C. Benz. 1990. Composting poultry carcasses. MP 317. Cooperative Extension Service, University of Arkansas. Fayetteville, AR.
- Bos, R.E. 1974. Dewatering bovine manure. M.S. Thesis, Agric. Eng. Dept., The Pennsylvania State University. University Park, PA.
- Brinton, W. n.d. Agricultural and horticultural applications of compost. Woods End Research Laboratory. Mount Vernon, ME.

- Brinton, W.F., Jr. 1990. Agricultural waste management and composting. Woods End Research Laboratory. Amer. Soc. Agron., NE An. Meet., University of New Hampshire. Durham, NH.
- Brinton, W.F., and M.D. Seekins. 1988. Composting fish by-products—A feasibility study. Tiem & Tide RC&D. Waldoboro, ME.
- Calhoun, G.D. 1982. Personal communication. DeLaval, Agric. Div. Kansas City, MO.
- Cassidy, J.M. (n.d.) Agricultural regulations for Massachusetts compost products. Bur. Farm Prod., Massachusetts Dept. Food and Agric.
- Cathcart, T.P., D.W. Lipton, F.W. Wheaton, R.B. Brinsfield, D.G. Swartz, and I.E. Strand. Composting of blue crab waste. University of Maryland. College Park, MD. Pub. No. UM-SG-Ts-84-01.
- Cathcart, T.P., F.W. Wheaton, and R.B. Brinsfield. 1986. Optimizing variables affecting composting of blue crab scrap. University of Maryland. College Park, MD.
- Cheremisnoff, P.N., and R.A. Young. 1975. Pollution engineering practice handbook. Ann Arbor Sci. Pub., Inc. Ann Arbor, MI. pp 788-792.
- Clark, J.W., W. Viessman, Jr., and M.J. Hammer. 1971. Water supply and pollution control. Int. Textbook Co. Scranton, PA. pp 579-584.
- Commonwealth Marketing and Development. 1988. Midcoast compost project market study. Portland, MA.
- Costa, C.A. 1987. Introduction: Why consider composting. MA Dept. Food and Agric., On-farm Composting Conf., University of Massachusetts. Amhurst, MA.
- Eberhardt, D.L., and W.O. Pipes. 1972. Composting applications for Illinois. IIEQ Doc.No. 73-5, IL Inst. Environ. Qual.
- Eccles, C., and E.I. Stentiford. 1987. Microcomputers monitor static pile performance. Biocycle, The JG Press, Inc. Emmaus, PA. pp. 42-45.
- Ely, J.F., and E.L. Spencer. 1978. The composting alternative waste disposal in remote locations. Res. Dept. Appalachian, MT.
- Fairbank, C.W. 1974. Energy values. *Agricultural Engineering*, ASAE. St. Joseph, MI. Sept. issue.
- Fulford, B. Composting dairy manure with newspaper and cardboard. The New Alchemy Institute. Falmouth, MA.
- Geiger, J.S. Composting with dairy and horse manure and fish wastes. Appleton Farms. Ipswich, MA.
- Glerum, J.C., G. Klamp, and H.R. Poelma. 1971. The separation of solid and liquid parts of pig slurry. *In* Livestock Waste Management and Pollution Abatement. ASAE. St. Joseph, MI. pp. 345-347.
- Graves, R.E., and J.T. Clayton. 1972. Stationary sloping screen to separate solids from dairy cattle manure slurries. ASAE Paper 72-951. St. Joseph, MI. 16 pp.
- Graves, R.E., et al. 1986. Manure management for environmental protection. PA Dept. Env. Resources. Harrisburg, PA.
- Guest, R.W. 1984. Gravity manure handling. NRAES/NDPC 27.10, Agric. Eng. Dept., Cornell University. Ithaca, NY. 4 pp.
- Hansen, R.C., and K.M. Mancl. 1988. Modern composting, a natural way to recycle wastes. The Ohio State University. Columbus, OH.
- Haug, R.T., and L.D. Tortorici. 1986. Composting process design criteria. Biocycle, Nov/Dec 1986 issue. The JG Press, Inc. Emmaus, PA
- Hegg, R.O., R.E. Larson, and J.A. Moore. 1981. Mechanical liquid-solid separation in beef, dairy, and swine waste slurries. Transactions of ASAE 24(1):159-163. St. Joseph, MI.

- Higgins, A.J. 1990. Engineering parameters for the selection of compost bulking agents. ASAE, NAR 83–207. St. Joseph, MI.
- Holmberg, R.D., D.T. Hill, T.J. Prince, and N.J. Van Dyke. 1982. Solid-liquid separation effect on physical properties of flushed swine waste. ASAE Paper 82–4081. St. Joseph, MI. 26 pp.
- Jones, D.D., D.L. Day, and A.C. Dale. 1971. Aerobic treatment of livestock wastes. University of Illinois Agric. Exp. Sta. Bull. 737. Urbana-Champaign, IL. 55 pp.
- Keener, H. M., D.L. Elwell, and M.J. Monnin. 2000. Procedures and equations for sizing of structures and windrows for composting animal mortalities. *Applied Engineering in Agriculture* 16(6):681–692.
- Kilmer, V.J. 1982. Handbook of soils and climate in agriculture. CRC Press. Boca Raton, FL.
- Kuter, G. 1987. Commercial in-vessel composting of agricultural wastes. Int. Process Sys. Lebanon, CT.
- Laliberty, L. 1987. Composting for a cash crop. Farm Res. Ctr. Putnam, CT.
- Livestock and Poultry Environmental Stewardship (LPES) Curriculum. 2001. Midwest Plan Service and USEPA. MacLean, A.J, and F.R. Hore. 1974. Manures and compost. Canada Dept. Agric. Pub. 868.
- McKinney, R.E. 1962. Microbiology for sanitary engineers. McGraw-Hill, Inc. New York, NY. pp. 260–265.
- Mezitt, R.W. 1985. Composting for the nursery industry. Weston Nursery, Inc. Hopkinton, MA.
- Midwest Plan Service. 1985. Biological treatment. Livest. waste fac. handb. MWPS–18. Iowa State University. Ames, IA.
- Millar, C.G., L.M. Turk, and H.D. Foth. 1965. Fundamentals of soil science. John Wiley & Sons, Inc. New York, NY.
- Morse, D.E., K. Friendshuh, M. Hanks, R. Iwan, and D. Schmidt. 2001. Composting animal mortalities. Agricultural Development Division. Minnesota Department of Agriculture. St. Paul, MN.
- Murphy, D.W. 1988. Composting of dead birds. Dept. Poultry Science 67, supplement 1 (1988):124. University of Maryland. Princess Anne, MD.
- Nessen, F. 1989. Present and future composting regulation in Massachusetts. MA. Dept. Environ. Qual. and Eng.
- New Hampshire Department of Agriculture. 1989. Good neighbor guide for horse-keeping: Manure management. USDA Ext. Serv. Pub. No. 89–EWQI–1–9186.
- Ngoddy, P.O., J.P. Hayser, R.K. Collins, G.D. Wells, and F.A. Heider. 1971. Closed system waste management for livestock water pollution control. Research Series, USEPA Project 13040DKP. Washington, DC.
- North Carolina State University. 1980. Earthen liquid manure storage basin with access ramp. Agric. Ext. Serv. Raleigh, NC.
- Parsons, R.A. 1984. On-farm biogas production. NRAES–20. NE Reg. Agric. Eng. Serv., Cornell University. Ithaca, NY. 38 pp.
- Pennsylvania Department of Environmental Resources. 1990. Assessment of field manure nutrient management with regards to surface and ground water quality. Harrisburg, PA
- Plovanich C.J. n.d. In-vessel composting of cattle and swine manure. Revere Copper and Brass, Inc. Rome, NY.
- Plovanich, C.J. n.d. In-vessel composting overview. Revere Copper and Brass, Inc. Rome, NY.
- Poincelot, R.P. 1975. The biochemistry and methodology of composting. CT Agric. Exp. Stat. New Haven, CT.



- Rynk, R. 1987. On-farm composting: The opportunities, benefits and drawbacks. Eng. Notes, University of Massachusetts. Amhurst, MA.
- Rynk, R. 1988. On-farm composting: The process and methods. Eng. Notes, University of Massachusetts. Amhurst, MA.
- Rynk, R. 1989. Composting as a dairy manure management technique. Dairy Manure Mgt. Symp. NRAES-31. Syracuse, NY.
- Rodale, J.I. 1975. The complete book of composting. Rodale Books, Inc. Emmaus, PA.
- Rodale, J.I. 1968. The encyclopedia of organic gardening. Rodale Books, Inc. Emmaus, PA. pp 151–153.
- Safley, L.M., Jr., and W.C. Fairbank. 1983. Separation and utilization of manure solids. Proceed. Sec. Natl. Dairy Housing Conf., ASAE. St. Joseph, MI. pp. 77–91.
- Salvato, J.A., Jr. 1982. Environmental engineering and sanitation. Wiley Interscience. John Wiley & Sons, INC. New York, NY. pp 403–406.
- Shutt, J.W., R.K. White, E.P. Taiganides, and C.R. Mote. 1975. Evaluation of solids separation devices. *In* Managing livestock wastes, ASAE. St. Joseph, MI. pp. 463–467.
- Simpson, M. 1987. Economics of agricultural composting. Bureau of Solid Waste Disposal. Amherst, MA.
- Singley, M.E. 1983. Preparing organic materials for composting. ASAE Paper NAP 83–208. St. Joseph, MI.
- Small Farm Energy Project Newsletter. 1979. Composting of farm manure. Issue No. 17. Center for Rural Affairs. Lyons, NE.
- Sweeten, J. M. 1979. Manure Management for Cattle Feedlots. L-1094, Texas Agricultural Extension Service, Texas A&M University. College Station, TX. 6 pp.
- Sweeten, J.M. 1988a. Composting manure and sludge. L-2289, Texas Agricultural Extension Service, Texas A&M University. College Station, TX. 4 pp.
- U.S. Department of Agriculture, Animal and Plant Health Inspection Service. 2001. Part I: Reference of swine health and management in the United States, 2000. National Animal Health Monitoring System. Fort Collins, CO. #N338.0801.
- U.S. Department of Agriculture, Animal and Plant Health Inspection Service. 2005. Sheep and lamb nonpredator death loss in the United States, 2004. USDA-APHIS-VS,CEAH, National Animal Health Monitoring System. Fort Collins, CO. #N445.0906
- U.S. Department of Agriculture, Animal and Plant Health Inspection Service. 2006. Cattle and calves death loss in the United States, 2000. USDA-APHIS-VS, CEAH. Fort Collins, CO. #N446.0606.
- U.S. Department of Agriculture, Animal and Plant Health Inspection Service. 2007. Trends in equine mortality, 1998–2005. USDA-APHIS-VS, CEAH. Fort Collins, CO. #N471-0307.
- U.S. Department of Agriculture, Soil Conservation Service. 1980. Design of mechanically aerated lagoons for odor control. Tech. Notes. Portland, OR. 9 pp.
- U.S. Department of Agriculture, Soil Conservation Service. 1981. Tentative guidelines for methane production by anaerobic digestion of manure. National Bulletin No. 210-1-13. Washington, DC. 7 pp.
- U.S. Environmental Protection Agency. 1977. Municipal sludge management: Environmental factors. EPA 430/9-77-004, USEPA. Washington. DC.
- U.S. Environmental Protection Agency. 1988. Design manual—Constructed wetlands and aquatic plant systems for municipal wastewater treatment. EPA/625/1-88/022. Washington, DC.
- U.S. Environmental Protection Agency. 1989. In-vessel composting of municipal wastewater sludge. USEPA Summary Rep. No. EPA/625/8-89/016. Washington, DC.
- University of Delaware, College of Agricultural Sciences, Agricultural Experiment Station. 1989. Dead poultry disposal. Newark, DE

University of Tennessee. 1977. Covered dry stack manure storage. Agric. Ext. Serv., Plan No. T4029, University of Tennessee. Knoxville, TN.

White, R.K., and D.L. Forster. 1978. Evaluation and economic analysis of livestock waste management systems. EPA/2-78-102. USEPA. Ada, OK. 302 pp.

White, R.K., and C.W. Young. 1980. Safety and liquid manure handling. OH Coop. Ext. Serv., AEX 703. Ohio State University. Columbus, OH. 3 pp.

Woods End Research Laboratory. Compost standards for MaDEQE. Mount Vernon, ME.

Wright, R.E. Assoc., Inc. 1990. Assessment of field manure nutrient management with regards to surface and ground water quality. PA Dept. Environ. Resource. Harrisburg, PA.

---

**651.1050 Appendix 10A—Blank  
worksheets**



# Worksheet 10A-1—Waste storage structure capacity design

Decisionmaker: _____	Date: _____
Site: _____	
<b>Animal units</b>	
1. Animal type _____	3. Number of animals (N) _____
2. Animal weight, lbs (W) _____	4. Animal units, $AU = \frac{W \times N}{1000} =$ _____
<b>Manure volume</b>	
5. Daily volume of daily manure production per AU, ft <sup>3</sup> /AU/day (DVM)= _____	7. Total volume of manure production for animal type for storage period, ft <sup>3</sup> $VMD = AU \times DVM \times D =$ _____
6. Storage period, days (D) = _____	8. Total manure production for storage period, ft <sup>3</sup> (TVM) _____
<b>Wastewater volume</b>	
9. Daily wastewater volume per AU, ft <sup>3</sup> /AU/day (DWW) = _____	11. Total wastewater volume for storage period, ft <sup>3</sup> (TWW) _____
10. Total wastewater volume for animal description for storage period, ft <sup>3</sup> $WWD = DWW \times AU \times D =$ _____	
<b>Bedding volume</b>	
12. Amount of bedding used daily for animal type, lbs/AU/day (WB) = _____	14. Bedding volume for animal type for storage period, ft <sup>3</sup> BV = _____
13. Bedding unit weight, lbs/ft <sup>3</sup> (BUW) = _____	$VBD = \frac{0.5 \times WB \times AU \times D}{BUW}$
	15. Total bedding volume for storage period, ft <sup>3</sup> (TBV) = _____
<b>Minimum waste storage volume requirement</b>	
16. Waste storage volume, ft <sup>3</sup> (WV) = TVM + TWW + TBV = _____ + _____ + _____ = _____	
<b>Waste stacking structure sizing</b>	
17. Structure length, ft $L = \frac{WV}{WI \times H} =$ _____	19. Structure height, ft $H = \frac{WV}{L \times WI} =$ _____
18. Structure width, ft $WI = \frac{WV}{L \times H} =$ _____	
Notes for waste stacking structure:	
1. The volume determined (WV) does not include any volume for freeboard. It is recommended that a minimum of 1 foot of freeboard be provided for a waste stacking structure.	2. The equations for L, WI, and H assume manure is stacked to average height equal to the sidewall height. Available storage volume must be adjusted to account for these types of variations.
<b>Tank sizing</b>	
20. Effective depth, ft. (EH) Total height (or depth) of tank desired, ft (H)----- _____ Less precipitation for storage period, ft. ---- - _____ (uncovered tanks only) Less depth allowance for accumulated solids, ft - _____ (0.5 ft. minimum) Less depth for freeboard (0.5 ft. recommended), ft - _____  Effective depth, ft (EH) = _____	22. Rectangular tank dimensions Total height, ft (H) = _____ Selected width, ft (WI) = _____  Length, ft $L = \frac{SA}{WI} =$ _____
21. Surface area required, ft <sup>2</sup> $SA = \frac{WV}{EH} =$ _____	23. Circular tank dimensions Total height, ft H = _____  Diameter, ft $DIA = (1.273 \times SA)^{0.5} =$ _____
	Notes for waste storage tank structure: 1. Final dimensions may be rounded up to whole numbers or to use increments on standard drawings. 2. Trial and error may be required to establish appropriate dimensions.

# Worksheet 10A-2—Waste storage pond design

Decisionmaker: _____	Date: _____							
Site: _____								
<b>Animal units</b>								
1. Animal type _____	3. Number of animals (N) _____							
2. Animal weight, lbs (W) _____	4. Animal units, $AU = \frac{W \times N}{1000} =$ _____							
<b>Manure volume</b>								
5. Daily volume of manure production per AU, ft <sup>3</sup> /AU/day (DVM)= _____	7. Total volume of manure production for animal type for storage period, ft <sup>3</sup> VMD = AU x DVM x D = _____							
6. Storage period, days (D) = _____	8. Total manure production for storage period, ft <sup>3</sup> (TVM) _____							
<b>Wastewater volume</b>								
9. Daily wastewater volume per AU, ft <sup>3</sup> /AU/day (DWW) = _____	11. Total wastewater volume for storage period, ft <sup>3</sup> (TWW) _____							
10. Total wastewater volume for animal description for storage period, ft <sup>3</sup> WWD = DWW x AU x D = _____								
<b>Clean water volume</b>	<b>Runoff volume</b>							
12. Clean water added during storage period, ft <sup>3</sup> (CW) _____	13. Runoff volume, ft <sup>3</sup> (ROV) (attach documentation) _____ Includes the volume of runoff from the drainage area due to normal runoff for the storage period and the runoff volume from the 25-year, 24-hour storm.							
<b>Solids accumulation</b>								
14. Volume of solids accumulation, ft <sup>3</sup> (VSA) _____								
<b>Minimum waste storage volume requirement</b>								
15. Waste storage volume, ft <sup>3</sup> (WSV) = TVM + TWW + CW + ROV + VSA = _____ + _____ + _____ + _____ + _____ = _____								
<b>Pond sizing</b>								
16. Sizing by trial and error								
Side slope ratio, (Z) = _____ V must be equal to or greater than WSV = _____ ft <sup>3</sup>								
Rectangular pond,	Circular pond,							
$V = \left( \frac{4 \times Z^2 \times d^3}{3} \right) + (Z \times BL \times d^2) + (Z \times BW \times d^2) + (BW \times BL \times d) \quad V = (1.05 \times Z^2 \times d^3) + (1.57 \times W \times Z \times d^2) + (0.79 \times W^2 \times d)$								
Trial no.	Bottom width ft (BW)	Bottom length ft (BL)	Depth* ft (d)	Volume ft <sup>3</sup> (V)	Trial no.	Bottom diameter (DIA)	Depth* ft (d)	Volume ft <sup>3</sup> (V)
_____	_____	_____	_____	_____	_____	_____	_____	_____
_____	_____	_____	_____	_____	_____	_____	_____	_____
_____	_____	_____	_____	_____	_____	_____	_____	_____
_____	_____	_____	_____	_____	_____	_____	_____	_____
* Depth must be adjusted in Step 17.								
<b>Depth adjustment</b>								
17. Depth adjustment								
Depth, ft (d) _____								
Add depth of precipitation less evaporation _____ + _____ (For the storage period)				Add for freeboard (1.0 foot minimum) + _____				
Add depth of 25-year, 24-hour storm _____ + _____				Final depth _____				

## Worksheet 10A-3—Anaerobic lagoon design

Decisionmaker: _____	Date: _____
Site: _____	
<b>Animal units</b>	
1. Animal type _____	3. Number of animals (N) _____
2. Animal weight, lbs (W) _____	4. Animal units, $AU = \frac{W \times N}{1000} =$ _____
<b>Manure volume</b>	
5. Daily volume of daily manure production per AU, $ft^3/AU/day$ (DVM) = _____	7. Total volume of manure production for animal type for treatment period, $ft^3$ $VMD = AU \times DVM \times D =$ _____
6. Treatment period, days (D) = _____	8. Total manure production for treatment period, $ft^3$ (TVM) = _____
<b>Wastewater volume</b>	
9. Daily wastewater volume per AU, $ft^3/AU/day$ (DWW) = _____	11. Total wastewater volume for treatment period, $ft^3$ (TWW) = _____
10. Total wastewater volume for animal description for treatment period, $ft^3$ $WWD = DWW \times AU \times D =$ _____	
<b>Clean water volume</b>	
12. Clean water added during treatment period, $ft^3$ (CW) = _____	
<b>Waste volume</b>	
13. Waste volume for treatment period, $ft^3$ $WV = TVM + TWW + CW =$ _____ + _____ + _____ = _____	
<b>Manure total solids</b>	
14. Daily manure total solids production, lbs/AU/day (MTS) = _____	16. Total manure total solids production, lbs/day (TMTS) = _____
15. Daily manure total solids production for animal type, lbs/day $MTSD = MTS \times AU =$ _____	
<b>Manure volatile solids</b>	
17. Daily manure volatile solids production per AU, lbs/AU/day (MVS) = _____	
18. Daily manure volatile solids production for animal type per day, lbs/day $MVSD = AU \times MVS =$ _____	
19. Total manure volatile solids production, lbs/day (TMVS) = _____	
<b>Wastewater volatile solids</b>	
20. Daily wastewater volatile solids production, lbs/1000 gal (DWVS) = _____	
21. Total wastewater volatile solids production for animal type, lbs/day $WVSD = \frac{DWVS \times DWW \times 7.48}{D \times 1,000} =$ _____	
22. Total wastewater volatile solids production, lbs/day (TWVS) = _____	
<b>Total volatile solids (manure and wastewater)</b>	
23. Total daily volatile solids production, lbs/day $TVS = TMVS + TWVS =$ _____ + _____ = _____	
<b>Minimum treatment volume</b>	
24. Selected lagoon VS loading rate, lbs VS/1,000 $ft^3$ (VSLR) = _____	25. Minimum treatment volume, $ft^3$ $MTV = \frac{TVS \times 1000}{VSLR} = \frac{( ) \times 1000}{( )} =$ _____
<b>Sludge volume requirement</b>	
26. Sludge accumulation ratio, $ft^3/lb$ TS (SAR) = _____	28. Sludge volume requirement, $ft^3$ $SV = 365 \times TMVS \times T \times SAR$
27. Sludge accumulation period, years (T) = _____	= $365 \times ( ) \times ( ) \times ( ) =$ _____
<b>Minimum lagoon volume requirement</b>	
29. Minimum lagoon volume requirements, $ft^3$ $(MLVR) = MTV + SV + WV =$ _____ + _____ + _____ = _____	

**Worksheet 10A-3—Anaerobic lagoon design—Continued**

**Lagoon sizing**

30. Sizing by trial and error 
$$V = \frac{(4 \times Z^2 \times d^3)}{3} + (Z \times BL \times d^2) + (Z \times BW \times d^2) + (BW \times BL \times d)$$

Side slope ratio, (Z) = \_\_\_\_\_

V must be equal to or greater than MLVR = \_\_\_\_\_ ft<sup>3</sup>

Trial no.	Bottom width ft (BW)	Bottom length ft (BL)	Depth* ft (d)	Volume ft <sup>3</sup> (V)
_____	_____	_____	_____	_____
_____	_____	_____	_____	_____
_____	_____	_____	_____	_____
_____	_____	_____	_____	_____

\* Depth must be adjusted in Step 31.

**Depth adjustment**

31. Depth adjustment

Depth, ft (d) .....

Add depth of precipitation less evaporation on lagoon surface .....+  
(for the treatment period)

Add depth of 25-year, 24-hour storm ..... +

Add for freeboard (1.0 foot minimum) ..... +

Final depth .....

32. Compute total volume using final depth, ft<sup>3</sup> (use equation in step 30) .....



## Worksheet 10A-4—Aerobic lagoon design

Decisionmaker: _____	Date: _____
Site: _____	
<b>Animal units</b>	
1. Animal type _____	3. Number of animals (N) _____
2. Animal weight, lbs (W) _____	4. Animal units, $AU = \frac{W \times N}{1000} =$ _____
<b>Manure volume</b>	
5. Daily volume of daily manure production per AU, $ft^3/AU/day$ (DVM) = _____	7. Total volume of manure production for animal type for treatment period, $ft^3$ $VMD = AU \times DVM \times D =$ _____
6. Treatment period, days (D) = _____	8. Total manure production for treatment period, $ft^3$ (TVM) _____
<b>Wastewater volume</b>	
9. Daily wastewater volume per AU, $ft^3/AU/day$ (DWW) = _____	11. Total wastewater volume for treatment period, $ft^3$ (TWW) _____
10. Total wastewater volume for animal description for treatment period, $ft^3$ $WWD = DWW \times AU \times D =$ _____	
<b>Clean water volume</b>	
12. Clean water added during treatment period, $ft^3$ (CW) _____	
<b>Waste volume</b>	
13. Waste volume for treatment period, $ft^3$ $WV = TVM + TWW + CW =$ _____ + _____ + _____ = _____	
<b>Manure total solids</b>	
14. Daily manure total solids production, $lbs/AU/day$ (MTS) = _____	16. Total manure total solids production, $lbs/day$ (TMTS) = _____
15. Daily manure total solids production for animal type, $lb/day$ $MTSD = MTS \times AU =$ _____	
<b>Manure 5-day biochemical oxygen demand</b>	
17. Daily manure $BOD_5$ production per AU, $lbs/AU/day$ (MBOD) = _____	
18. Daily manure $BOD_5$ production for animal type per day, $lbs/day$ $MBOD = AU \times BOD =$ _____	
19. Total manure production, $lbs/day$ (TMBOD) _____	
<b>Wastewater 5-day biochemical oxygen demand</b>	
20. Daily wastewater $BOD_5$ production, $lbs/1000$ gal (DWBOD) _____ = _____	
21. Total wastewater $BOD_5$ production for animal type, $lbs/day$ $WBOD = \frac{(DWBOD \times TWW \times 7.48)}{D \times 1,000} =$ _____	
22. Total wastewater $BOD_5$ production, $lbs/day$ (TWBOD) _____ = _____	
<b>TOTAL <math>BOD_5</math> (manure and wastewater)</b>	
23. Total daily production, $lbs/day$ $TBOD = TMBOD + TWBOD =$ _____ + _____ = _____	
<b>Minimum treatment surface area</b>	
24. Selected lagoon $BOD_5$ loading rate, $lbs BOD_5/acre$ (BODLR) = _____	25. Minimum treatment surface area, acres $MTA = \frac{TBOD}{BODLR} = \frac{( )}{( )} =$ _____
<b>Sludge volume requirement</b>	
26. Sludge accumulation ratio, $ft^3/lb$ TS (SAR) = _____	28. Sludge volume requirement, $ft^3$ $SV = 365 \times TMTS \times T \times SAR$
27. Sludge accumulation period, years (T) = _____	$= 365 ( ) ( ) ( ) =$ _____
<b>Minimum lagoon volume requirement</b>	
29. Minimum lagoon volume requirements, $ft^3$ $MLVR = SV + WV =$ _____ + _____ = _____	

**Lagoon sizing**

30. Sizing by trial and error:

Side slope ratio, (Z) = \_\_\_\_\_

V must be equal to or greater than MLVR = \_\_\_\_\_ ft<sup>3</sup>

SA must be equal to or greater than MTA = \_\_\_\_\_ acres

Rectangular lagoon:

d must be less than 5 feet

$$SA = \frac{(BL + 2Zd)(BW + 2Zd)}{43,560}$$

$$V = \left( \frac{4 \times Z^2 \times d^3}{3} \right) + (Z \times BL \times d^2) + (Z \times BW \times d^2) + (BW \times BL \times d)$$

Trial no.	Bottom width ft (BW)	Bottom length ft (BL)	Depth* ft (d)	Volume ft <sup>3</sup> (V)	Surface area acres (SA)
_____	_____	_____	_____	_____	_____
_____	_____	_____	_____	_____	_____
_____	_____	_____	_____	_____	_____
_____	_____	_____	_____	_____	_____
_____	_____	_____	_____	_____	_____
_____	_____	_____	_____	_____	_____
_____	_____	_____	_____	_____	_____
_____	_____	_____	_____	_____	_____
_____	_____	_____	_____	_____	_____

\* Depth must be adjusted in Step 31

**Depth adjustment**

31. Depth adjustment

Depth, ft (d) ----- \_\_\_\_\_

Add depth of precipitation less evaporation on lagoon surface + \_\_\_\_\_  
(for the treatment period)

Add depth of 25-year, 24-hour storm ----- + \_\_\_\_\_

Add for freeboard (1.0 foot minimum) ----- + \_\_\_\_\_

Final depth ----- \_\_\_\_\_

32. Compute total volume using final depth, ft<sup>3</sup>

(use equation in step 30) ----- \_\_\_\_\_

## Worksheet 10A-5—Anaerobic digester design

Decisionmaker: _____	Date: _____
Site: _____	
<b>Animal units</b>	
1. Animal type _____	3. Number of animals (N) _____
2. Animal weight, lbs (W) _____	4. Animal units, AU = $\frac{W \times N}{1000}$ = _____
<b>Manure volume</b>	
5. Daily volume of daily manure production per AU, ft <sup>3</sup> /AU/day (DVM) = _____	7. Total daily manure production volume, ft <sup>3</sup> /day (TMP) _____
6. Total volume of daily manure production for animal type, ft <sup>3</sup> /day $MPD = AU \times DVM$ _____	
<b>Manure total solids</b>	
8. Daily manure total solids production, lbs/AU/day (MTS) = _____	10. Total manure total solids production, lbs/day (TMTS) = _____
9. Daily manure total solids production for animal type, lb/day $MTSD = MTS \times AU$ = _____	
<b>Manure volatile solids</b>	
11. Daily manure volatile solids production per AU, lbs/AU/day (MVS) = _____	
12. Daily manure volatile solids production for animal type per day, lbs/day $MVSD = AU \times MVS$ _____	
13. Total manure volatile solids production, lbs/day (TMVS) _____	
<b>Percent solids</b>	<b>Digester feed solid concentration</b>
14. Percent solids, % (PS) $PS = \frac{TMTS \times 100}{TMP \times 62.4} = \frac{( \quad ) \times 100}{( \quad ) \times 62.4} =$ _____	15. Desired digester feed solids concentration, % (DDFSC) = _____
<b>Daily manure inflow</b>	<b>Digester effective volume</b>
16. Daily manure inflow, ft <sup>3</sup> $DMI = \frac{TMTS \times 100}{DDFSC \times 62.4} = \frac{( \quad ) \times 100}{( \quad ) \times 62.4} =$ _____	17. Digester effective volume, ft <sup>3</sup> $DEV = DMI \times 20 = ( \quad ) \times 20$ _____
<b>Digester dimensions</b>	19. Digest width, ft $WI = 2 \times H = 2 \times ( \quad )$ _____
18. Digester depth, ft $H = \left( \frac{DEV}{8} \right)^{0.33} = \left[ \frac{( \quad )}{8} \right]^{0.33} =$ _____	20. Digest length, ft $L = 4 \times H = 4 \times ( \quad )$ _____
<b>Estimated energy production</b>	
21. Biogas per unit (VS), ft <sup>3</sup> /lb (BUVS) _____	23. Estimated energy production BTU/day $EEP = EBP \times 600 = ( \quad ) \times (600)$ _____
22. Estimated biogas production ft <sup>3</sup> /day $EBP = BUVS \times TMVS = ( \quad ) \times ( \quad )$ _____	= _____

# Worksheet 10A-6—Monthly precipitation minus evaporation

Decisionmaker: _____	Date: _____
----------------------	-------------

Site: \_\_\_\_\_

Annual FWS Evaporation (FWS) = \_\_\_\_\_ inches

Month	Monthly precipitation MP (inches)	Monthly portion of annual evaporation MPAE (percent)	Monthly evaporation ME (inches)*	Monthly precipitation less evaporation MPLE (inches)
January	_____	_____	_____	_____
February	_____	_____	_____	_____
March	_____	_____	_____	_____
April	_____	_____	_____	_____
May	_____	_____	_____	_____
June	_____	_____	_____	_____
July	_____	_____	_____	_____
August	_____	_____	_____	_____
September	_____	_____	_____	_____
October	_____	_____	_____	_____
November	_____	_____	_____	_____
December	_____	_____	_____	_____

\*ME = FWS x MPAE

Storage or treatment period, days (D) = \_\_\_\_\_

months = \_\_\_\_\_

### Critical successive months

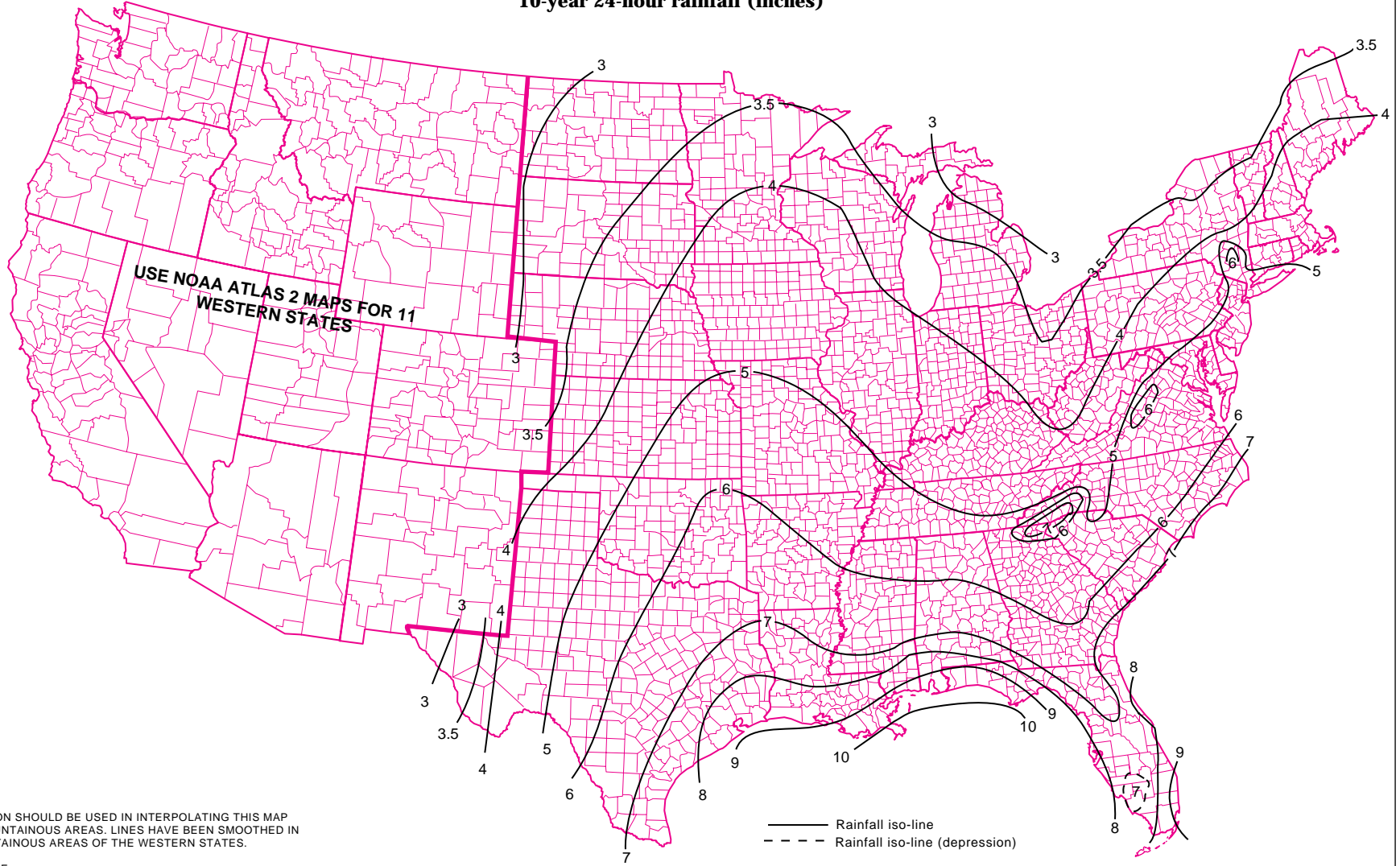
Month	Monthly precipitation less evaporation MPLE (inches)	Month	Monthly precipitation less evaporation MPLE (inches)
_____	_____	_____	_____
_____	_____	_____	_____
_____	_____	_____	_____
_____	_____	_____	_____
_____	_____	_____	_____
_____	_____	_____	_____
Total	-----		_____

---

**651.1060 Appendix 10B—Rainfall  
Intensity Maps**



**Figure 10B-1**  
**10-year 24-hour rainfall (inches)**



NOTE:  
CAUTION SHOULD BE USED IN INTERPOLATING THIS MAP  
IN MOUNTAINOUS AREAS. LINES HAVE BEEN SMOOTHED IN  
MOUNTAINOUS AREAS OF THE WESTERN STATES.

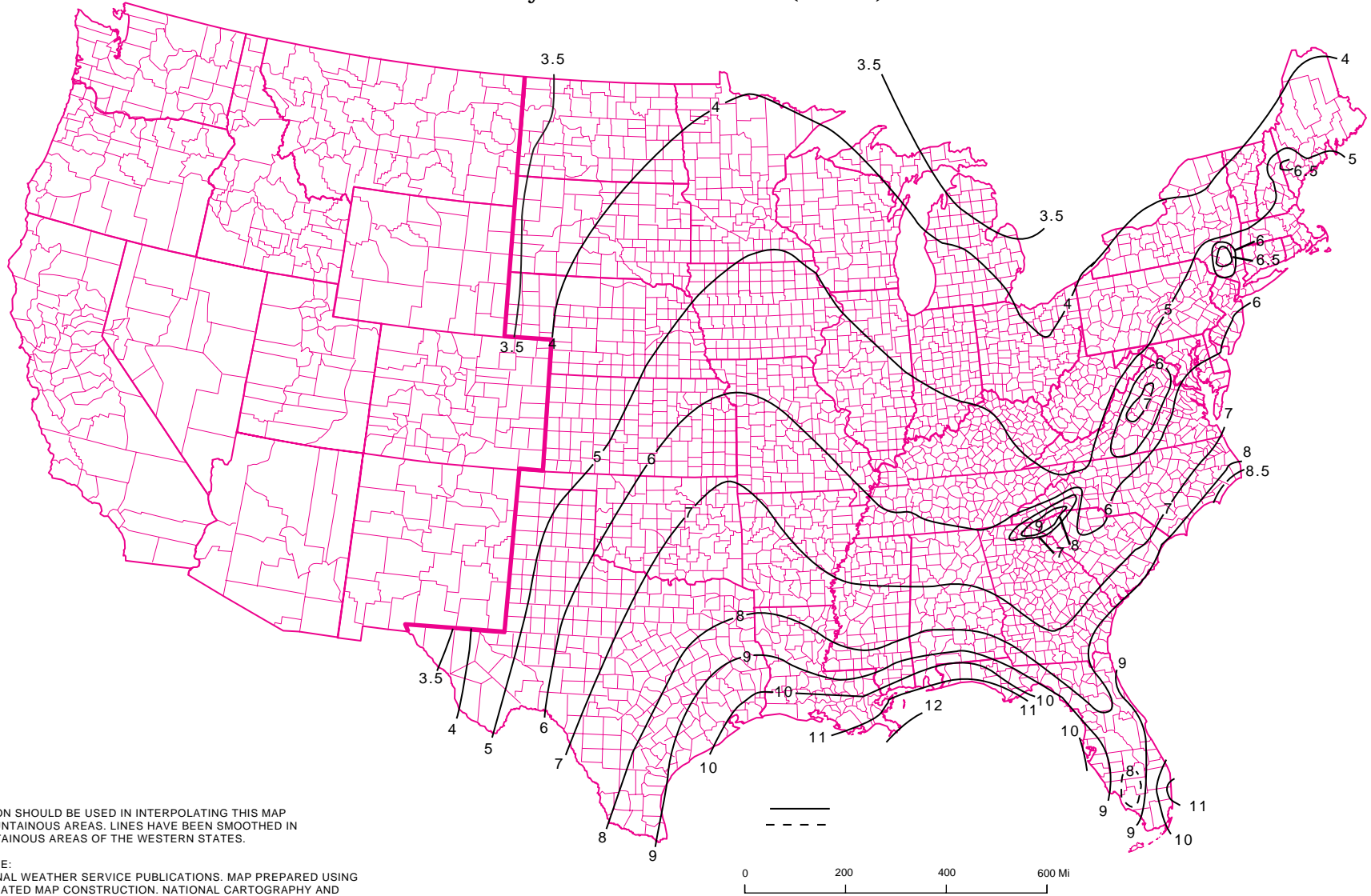
SOURCE:  
NATIONAL WEATHER SERVICE PUBLICATIONS. MAP PREPARED USING  
AUTOMATED MAP CONSTRUCTION. NATIONAL CARTOGRAPHY AND GIS  
CENTER, FORT WORTH, TEXAS, 1995



REVISED JUNE 1995, 1004822

(210-VI-AWMPFH, rev. 1, Amend. 31, July 1996)

**Figure 10B-2**  
**25-year 24-hour rainfall (inches)**

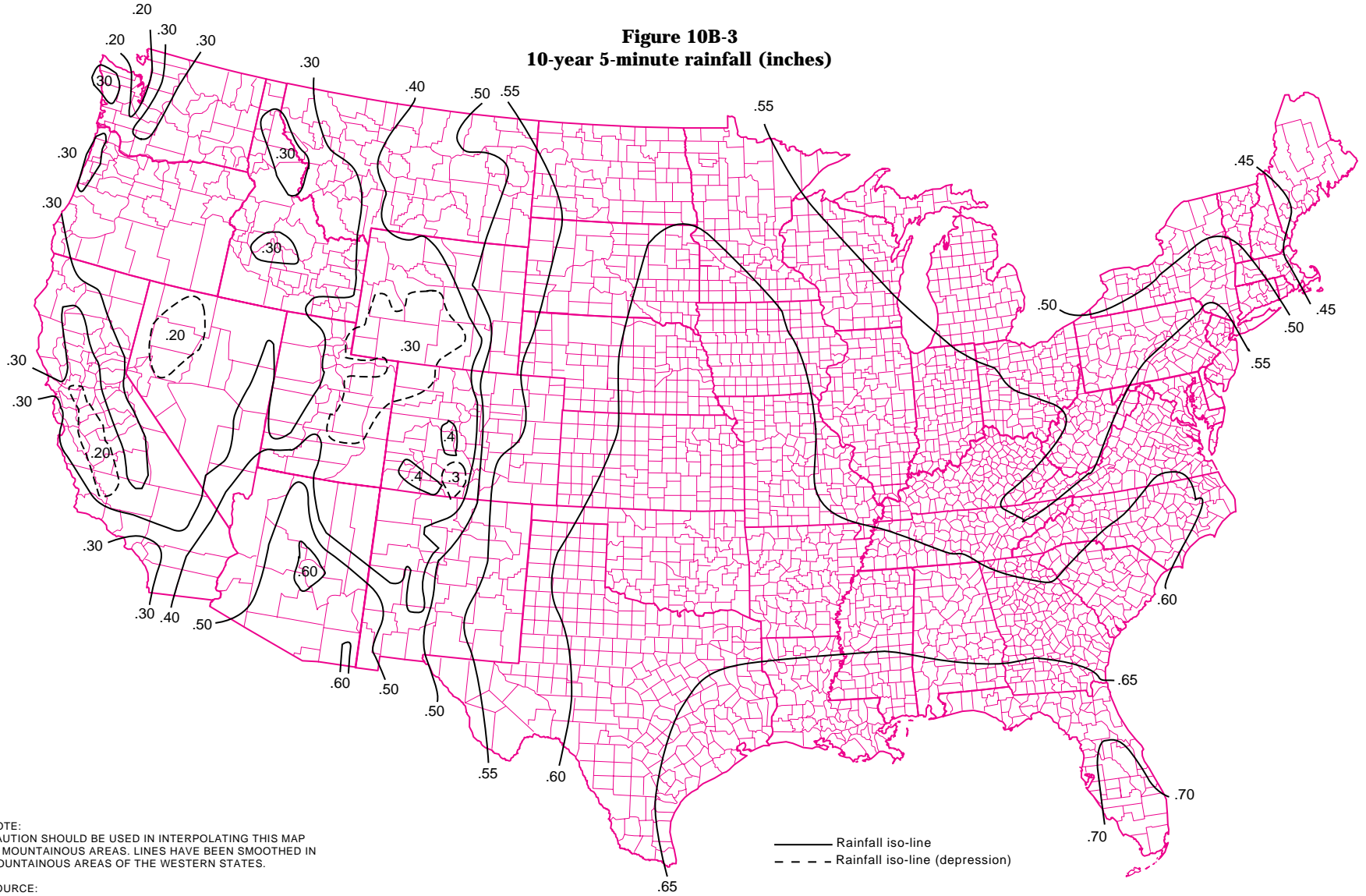


NOTE:  
CAUTION SHOULD BE USED IN INTERPOLATING THIS MAP  
IN MOUNTAINOUS AREAS. LINES HAVE BEEN SMOOTHED IN  
MOUNTAINOUS AREAS OF THE WESTERN STATES.

SOURCE:  
NATIONAL WEATHER SERVICE PUBLICATIONS. MAP PREPARED USING  
AUTOMATED MAP CONSTRUCTION. NATIONAL CARTOGRAPHY AND  
GIS CENTER, FORT WORTH, TEXAS, 1995



**Figure 10B-3**  
**10-year 5-minute rainfall (inches)**



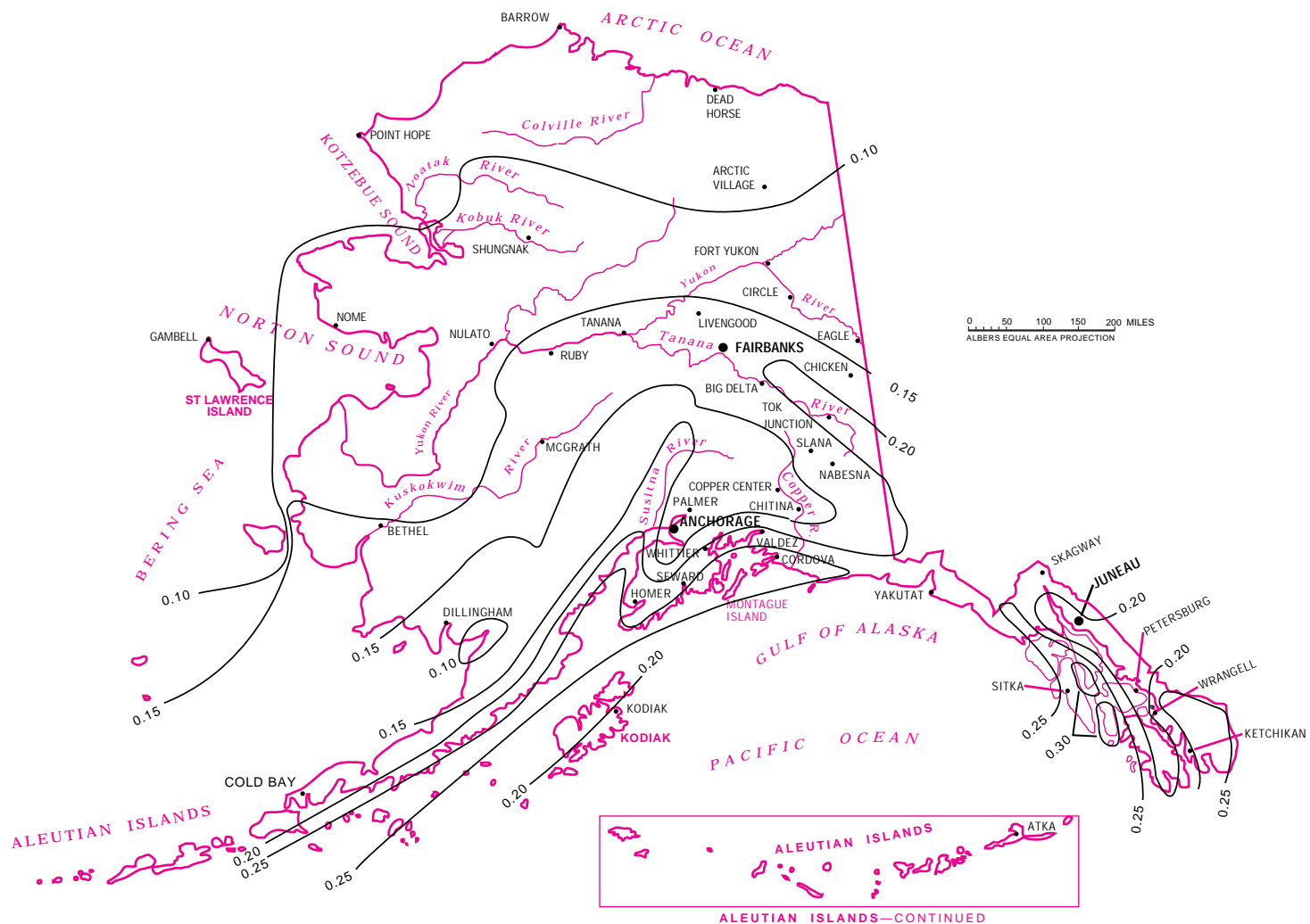
NOTE:  
CAUTION SHOULD BE USED IN INTERPOLATING THIS MAP  
IN MOUNTAINOUS AREAS. LINES HAVE BEEN SMOOTHED IN  
MOUNTAINOUS AREAS OF THE WESTERN STATES.

SOURCE:  
NATIONAL WEATHER SERVICE PUBLICATIONS. MAP PREPARED USING  
AUTOMATED MAP CONSTRUCTION. NATIONAL CARTOGRAPHY AND GIS CENTER,  
FORT WORTH, TEXAS, 1995

REVISED JUNE 1995, 1005773

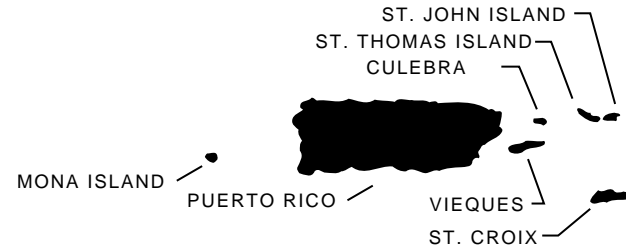
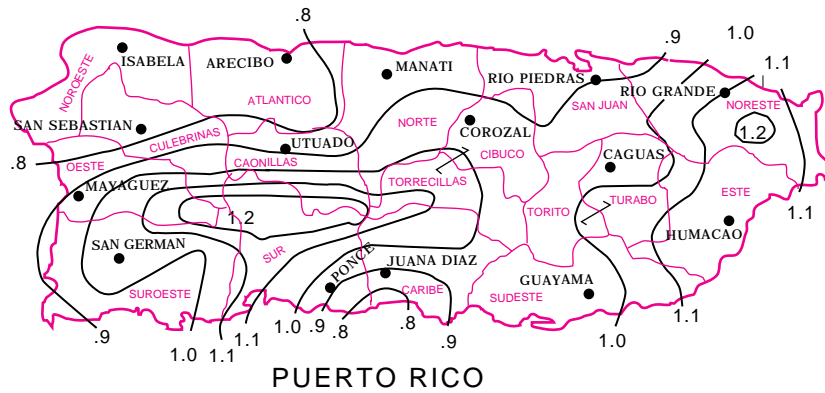
(210-VI-AWMPFH, rev. 1, Amend. 31, July 1996)

### FIGURE 10B-3a 10-YEAR 5-MINUTE RAINFALL (INCHES) ALASKA

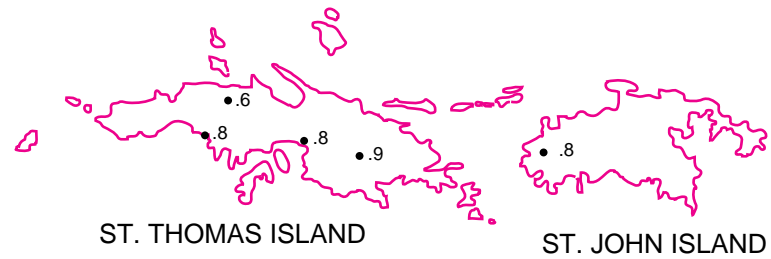


SOURCE:  
DATA PROVIDED BY SCS FIELD PERSONNEL  
NATIONAL CARTOGRAPHY AND GIS CENTER,  
FORT WORTH, TEXAS

**FIGURE 10B-3b**  
**10-YEAR 5-MINUTE RAINFALL (INCHES)**

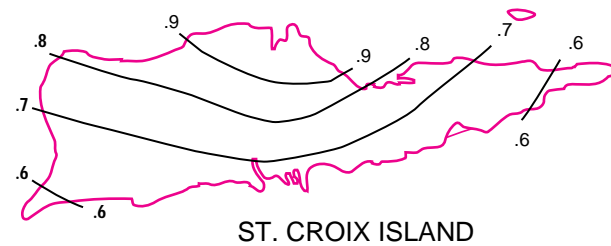


**LOCATION MAP**

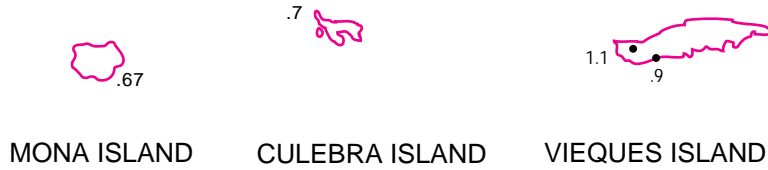


ST. THOMAS ISLAND

ST. JOHN ISLAND



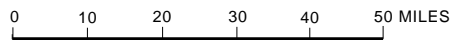
ST. CROIX ISLAND



MONA ISLAND

CULEBRA ISLAND

VIEQUES ISLAND



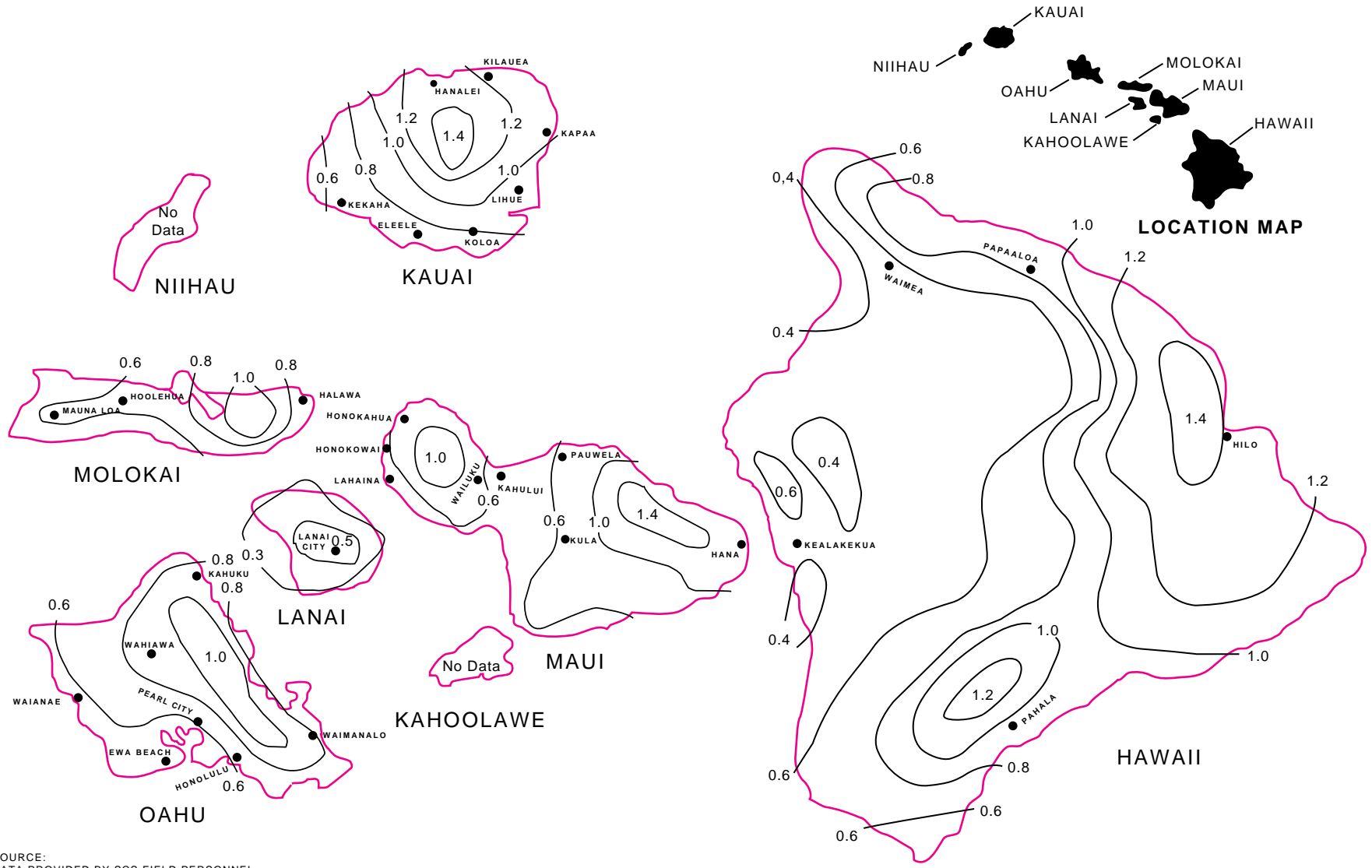
SOURCE:  
DATA PROVIDED BY SCS FIELD PERSONNEL.  
NATIONAL CARTOGRAPHY AND GIS CENTER,  
FORT WORTH, TEXAS

FEBRUARY 1994 1007913

U.S. DEPARTMENT OF AGRICULTURE

SOIL CONSERVATION SERVICE

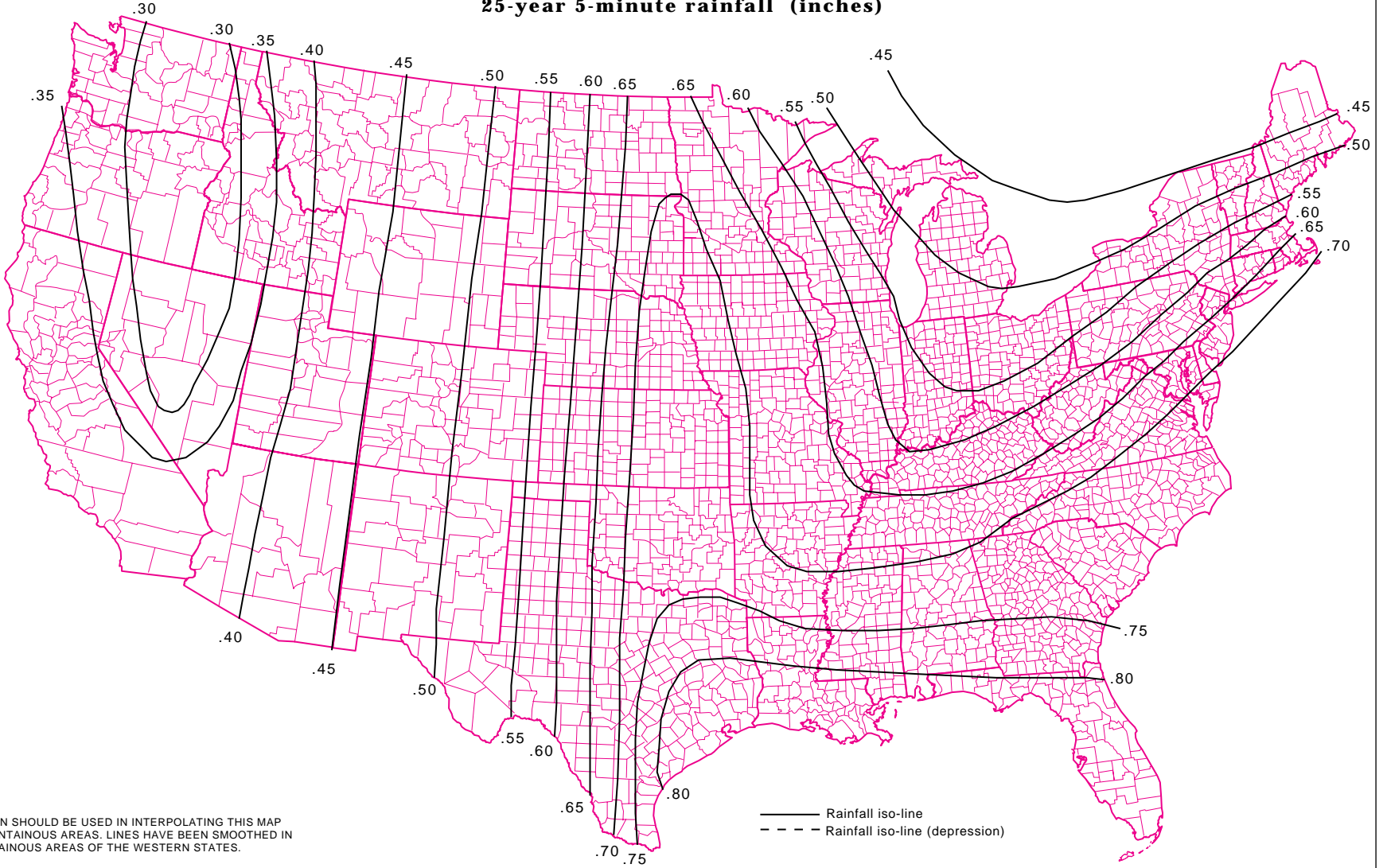
**FIGURE 10B-3c**  
**10-YEAR 5-MINUTE RAINFALL (INCHES)**



SOURCE:  
DATA PROVIDED BY SCS FIELD PERSONNEL  
NATIONAL CARTOGRAPHY AND GIS CENTER,  
FORT WORTH, TEXAS

FEBRUARY 1994 1007914

**Figure 10B-4**  
**25-year 5-minute rainfall (inches)**



NOTE:  
CAUTION SHOULD BE USED IN INTERPOLATING THIS MAP  
IN MOUNTAINOUS AREAS. LINES HAVE BEEN SMOOTHED IN  
MOUNTAINOUS AREAS OF THE WESTERN STATES.

SOURCE:  
NATIONAL WEATHER SERVICE PUBLICATIONS. MAP PREPARED USING  
AUTOMATED MAP CONSTRUCTION. NATIONAL CARTOGRAPHY AND GIS  
CENTER, FORT WORTH, TEXAS, 1995

0 200 400 600 Mi

REVISED JUNE 1995, 1004819

This page intentionally left blank.

---

## **651.1070 Appendix 10C—Runoff From Feedlots and Evaporation**



**(a) Runoff**

Runoff must be handled if feedlots or other components of the livestock production unit are exposed to the weather. Contaminated runoff should be collected in settling basins and storage ponds.

A paved or surfaced feedlot typically has a runoff curve number (RCN) of about 97; an RCN of 90 is representative of an unpaved or unsurfaced feedlot. Based on these RCN's, the amount of runoff from feedlots can be estimated as a percentage of the precipitation that is expected over a period of time.

Figures 10C-1 and 10C-2 describe for the continental United States the percentage of annual precipitation that will occur as runoff from unsurfaced and surfaced feedlots, respectively. Figures 10C-3 through 10C-14 describe the percentage of monthly precipitation that will occur as runoff from unsurfaced feedlots. Figures 10C-15 through 10C-26 describe the percentage of monthly precipitation that will occur as runoff from surfaced feedlots.

Other available sources give the annual or monthly precipitation data to which the runoff percentages are applied. One such source is "Climatography of the United States No. 81 (by state) Monthly Normals of Temperature, Precipitation, and Heating and Cooling Degree Days, 1941-70," prepared by the U.S. Department of Commerce, National Oceanic and Atmospheric Administration, Environmental Data Service. Another source available in many counties is the local soil survey, which contains a section on climatic data.

The runoff percentage from figures 10C-1 through 10C-26 is multiplied by the precipitation from the corresponding time period to determine the amount of runoff. This is the runoff volume (ROV) value used in several of the worksheets in chapter 10.

**Design example 10C-1—Runoff from a concrete feedlot**

Determine the annual runoff from a concrete feedlot near Portland, Oregon. From the reference cited, the mean annual precipitation is 37.6 inches. From figure 10C-2, the annual runoff is 49 percent of the precipitation. Therefore, the annual ROV = (37.6 in. x 0.49) = 18.4 inches.

**Design example 10C-2—Runoff from an earth feedlot**

Determine the runoff to be expected from an earth feedlot near Dallas, Texas, for the period October to March.

Month	Precip. (inches)	Runoff	
		%	(inches)
Oct.	3.18	36	1.14
Nov.	2.60	27	0.70
Dec.	2.34	24	0.56
Jan.	1.96	20	0.39
Feb.	2.57	20	0.51
Mar.	3.04	22	0.67
Total			3.97

**(b) Evaporation**

Storage and treatment facilities require an allowance for precipitation less evaporation for the most critical design period. For example, for a 90-day storage period, an allowance for storage is planned using the three successive months that result in the greatest sum of precipitation less evaporation that is critical.

Some ponds or structures, especially those containing dairy manure and straw bedding, develop a crust on the surface, and evaporation may be limited. This will vary among areas and individual farms. For a conservative design when crusting is anticipated, the allowance evaporation in the pond sizing can be omitted.

Local records are almost always available for the average monthly precipitation for each month of the year. Local records may also be available for average monthly evaporation. If evaporation data are not readily available, however, the annual free water surface evaporation (shallow lake evaporation) may be determined using figure 10C-27. Monthly free water surface evaporation may be determined using table 10C-1, which gives the approximate mean monthly percent of the annual evaporation for selected stations in the continental United States.

Table 10C-1 was developed for use in obtaining monthly evaporation for selected stations from annual Class A pan evaporation maps. This table is to be used



on free water surface maps. Although the information in this table is not completely correct, the monthly percentages are adequate for estimating free water surface evaporation. Several other factors prevent an exact correlation between evaporation from waste storage ponds and lagoon surfaces and Class A pan evaporation. Factors causing differences include effects of salinity, coloration, and floating surface material, such as bedding, on evaporation rates.

Worksheet 10A-6 can be used to determine the monthly precipitation less evaporation value for each month.

### Design example 10C-3

Mr. Austin Peabody of Rocky Mount, North Carolina, has selected an alternative for an agricultural waste management system that includes a waste storage pond. Designing the depth of the pond requires that an allowance for containing the precipitation evaporation minus evaporation for the storage period be determined. Using worksheet 10A-6, determine the precipitation less evaporation value to use for a 180-day storage period.

- The annual FWS evaporation (FWS) is selected from figure 10C-27.
- The monthly precipitation (MP) values are selected from local data.
- The monthly portion of annual evaporation (MPAE) is determined using the appropriate station in table 10C-1.
- The monthly evaporation (ME) is computed by the equation:

$$ME = FWS \times MPAE$$

- The monthly precipitation less evaporation (MPLE) is determined by the equation:
- $$MPLE = MP - ME$$
- The 180-day storage period is about 6 months; therefore, the successive 6 months that are critical are determined by inspection. For this example, the storage period is September through February.

- The total precipitation less evaporation depth that must be accommodated in the waste storage pond is the sum of monthly values for September through February.

## Completed worksheet for design example 10C-3

**Worksheet 10A-6 – Monthly precipitation minus evaporation**

Decisionmaker: <u>Austin Peabody</u>	Date: _____
Site: _____	
Annual FWS Evaporation (FWS)= <u>39</u> inches	

Month	Monthly precipitation MP (inches)	Monthly portion of annual evaporation MPAE (percent)	Monthly evaporation ME (inches)*	Monthly precipitation less evaporation MPLE (inches)
January	<u>3.53</u>	<u>3</u>	<u>1.17</u>	<u>2.36</u>
February	<u>3.71</u>	<u>5</u>	<u>1.95</u>	<u>1.76</u>
March	<u>3.49</u>	<u>8</u>	<u>3.12</u>	<u>0.37</u>
April	<u>3.50</u>	<u>10</u>	<u>3.90</u>	<u>-0.40</u>
May	<u>3.61</u>	<u>12</u>	<u>4.68</u>	<u>-1.07</u>
June	<u>4.47</u>	<u>13</u>	<u>5.07</u>	<u>-0.60</u>
July	<u>5.58</u>	<u>13</u>	<u>5.07</u>	<u>0.51</u>
August	<u>4.45</u>	<u>12</u>	<u>4.68</u>	<u>-0.23</u>
September	<u>3.95</u>	<u>9</u>	<u>3.15</u>	<u>0.44</u>
October	<u>2.79</u>	<u>7</u>	<u>2.73</u>	<u>0.06</u>
November	<u>2.24</u>	<u>5</u>	<u>1.95</u>	<u>0.29</u>
December	<u>3.49</u>	<u>3</u>	<u>1.17</u>	<u>2.32</u>

\*ME = FWS x MPAE

Storage or treatment period, days (D) = 180

months = 6

**Critical successive months**

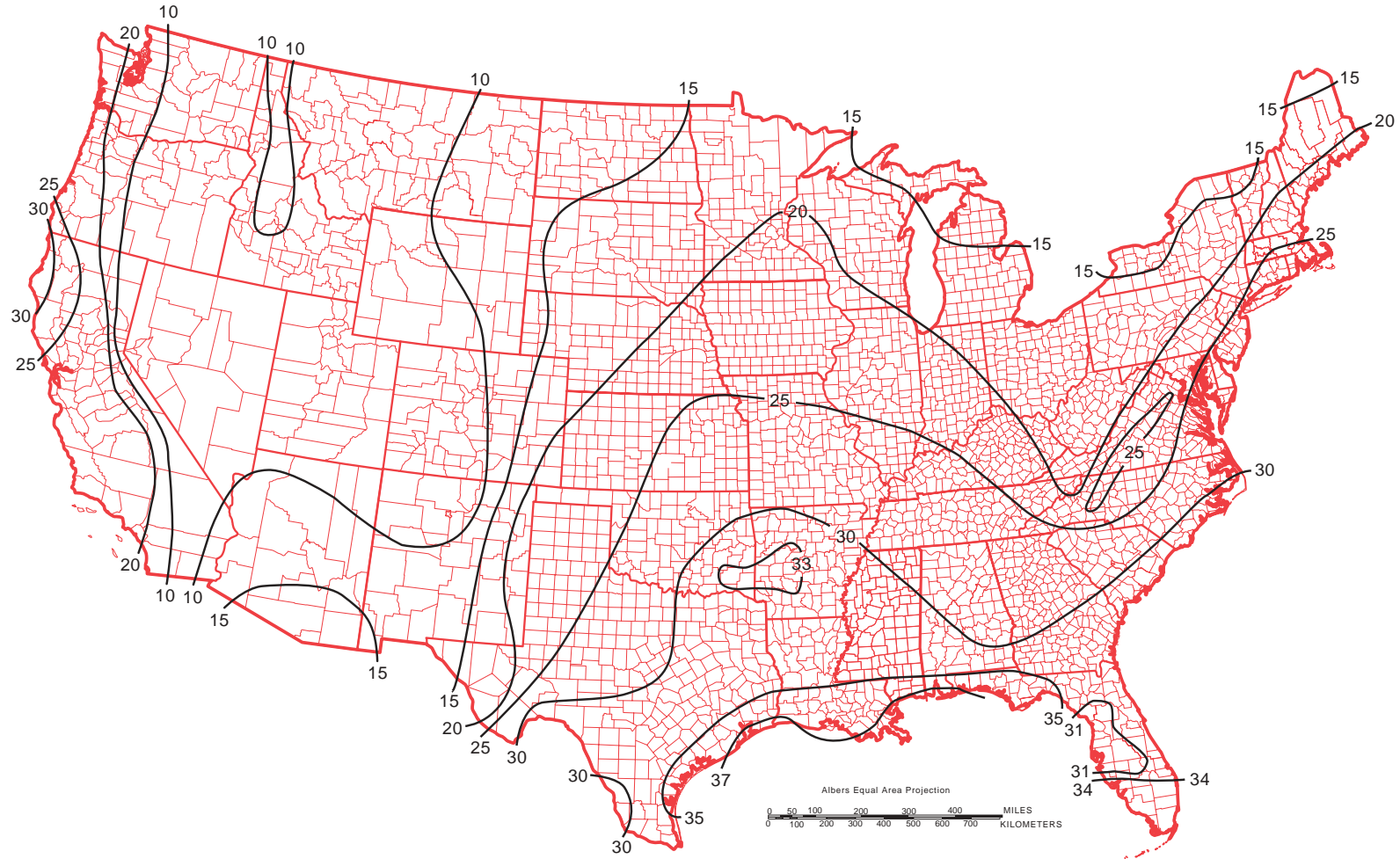
Month	Monthly precipitation less evaporation MPLE (inches)	Month	Monthly precipitation less evaporation MPLE (inches)
<u>SEPT</u>	<u>0.44</u>	_____	_____
<u>Oct</u>	<u>0.06</u>	_____	_____
<u>NOV</u>	<u>0.29</u>	_____	_____
<u>DEC</u>	<u>2.32</u>	_____	_____
<u>JAN</u>	<u>2.36</u>	_____	_____
<u>FEB</u>	<u>1.76</u>	_____	_____
Total -----			<u>7.2 inches</u>

**Table 10C-1** Adjusted approximate mean monthly free water surface evaporation for selected stations

Station name	Lat. Long -		Percent of annual													
	May	Nov	Jan	Feb	Mar	Apr	May	Jun	Jul	Aug	Sep	Oct	Nov	Dec	Oct	Apr
Fairhope, AL	30°32'	87°55'	4	5	7	10	12	13	12	11	9	8	5	4	65	35
Bartlett Darn, AZ	33°49'	111°38'	3	4	6	9	12	14	14	11	10	8	5	4	69	31
Bacus Ranch, CA	34°57'	118°11'	3	3	7	9	11	14	15	15	10	7	3	3	72	28
Sacramento, CA			2	3	6	8	12	15	16	15	11	7	3	2	76	24
Wagon Wheel Gap, CO	37°48'	106°58'					14	16	14	12	11	7			74	26
Hartford, CT			3	3	6	10	13	14	15	14	9	6	4	3	71	29
Tantiami Trail, FL	25°45'	80°50'	5	6	9	10	11	10	11	10	9	8	6	5	59	41
Experiment, GA	33°16'	84°17'	4	5	7	10	12	13	13	11	9	7	5	4	65	35
Moscow, U of I, ID	46°44'	116°58'				7	12	14	19	18	12	6			81	19
Pocatello, ID			2	2	6	8	12	15	19	14	11	6	3	2	77	23
Ames, IA	42°00'	98°39'				10	15	16	15	13	9	8	3		76	24
Toronto Darn, KS	37°45'	95°56'	2	3	7	10	13	13	15	14	9	8	4	2	72	28
Tribune, KS	38°28'	101°46'				9	12	14	16	14	10	7			73	27
Madisonville, KY	37°19'	87°29'				11	13	14	14	13	10	8			72	28
Urbana, IL	40°06'	88°14'				9	13	15	15	14	10	7	4		75	25
Woodworth S. F., LA	31°08'	92°28'	3	4	7	9	12	13	13	13	9	8	5	4	68	32
Caribou, ME	46°52'	68°01'	2	3	5	8	15	16	16	14	9	7	3	2	77	23
Rochester, MA	41°47'	70°55'				8	13	15	15	13	9	5			70	30
E.Lansing Hort Fin, MI	42°43'	84°28'				9	14	15	16	14	10	6	2		75	25
Scott, MS	33°36'	91°05'	3	4	7	10	13	14	13	12	9	7	5	3	68	32
Weldon Spr. Fin, MO	38°42'	90°44'				10	12	14	14	13	11	8	4		72	28
Bozeman Agr. C., MT	45°40'	111°09'				8	12	14	19	17	10	6			78	22
Medicine Ck Darn, NE	40°23'	100°13'				10	12	14	15	14	11	8			74	26
Boulder City, NV	35°59'	114°51'	3	4	6	9	12	14	15	13	10	7	4	3	71	29
Topaz Lake, NV	38°41'	119°02'				8	12	14	16	14	11	7	3		74	26
Elephant Bte Dam, NM	33°09'	107°11'	3	4	8	11	14	15	12	11	8	7	4	3	67	33
El Vado Dam, NM	36°36'	106°44'			10	10	15	14	15	12	9	6			71	29
Aurora Res Fin, NY	42°44'	76°39'				13	15	17	14	10	7				76	24
Chapel Hill, NC	25°55'	79°06'	3	5	8	10	12	13	13	12	9	7	5	3	66	34
Wooster Exp Sta, OH	40°47'	81°36'				9	13	15	15	14	10	7			74	26
Canton Dam, OK	36°05'	98°36'	3	4	7	10	11	13	14	14	9	7	5	3	68	32
Detroit Pwr. Hse, OR	44°43'	122°15'	1	2	4	7	12	15	22	18	11	5	2	1	83	17
Redfield, SD	44°53'	98°23'				10	13	15	17	16	11	7			79	21
Neptune, TN	36°19'	87°11'	2	4	7	11	12	14	14	13	9	7	4	3	69	31
Grapevine, TX	32°58'	97°03'	3	4	7	9	10	12	15	14	10	7	5	4	68	32
Welasco, TX	26°09'	97°48'	4	5	7	9	11	11	13	13	10	7	6	4	65	35
Utah Lake, UT	40°22'	111°54'			6	9	13	15	18	15	11	7			79	21
Templeau Darn, WI	44°00'	91°26'				14	16	16	14	10	8				78	22
Heart Mountain, WY	44°41'	108°57'				7	13	14	16	15	10	6			74	26

Source: Adapted from Evaporation Atlas for the Contiguous 48 United States, NOAA Technical Report NWS 33, Table 3-Adjusted mean monthly Class A pan evaporation for selected stations, 1956-70.

### ANNUAL RUNOFF FROM UNSURFACED FEEDLOTS (CN-90) AS PERCENT OF MEAN ANNUAL PRECIPITATION FIGURE 10C-1



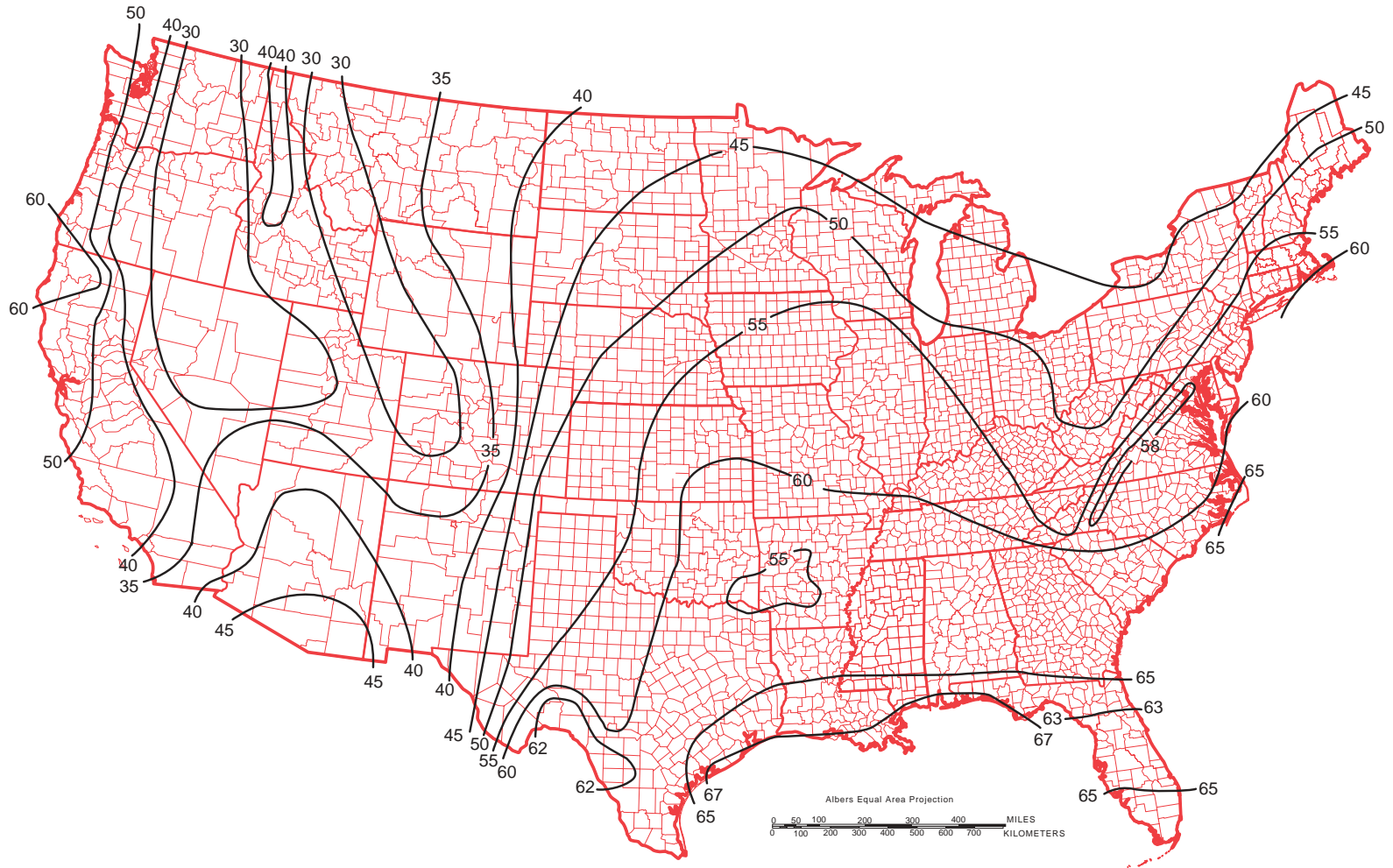
SOURCE:  
DATA PROVIDED BY SCS FIELD PERSONEL. MAP PREPARED USING  
AUTOMATED MAP CONSTRUCTION. NATIONAL CARTOGRAPHIC CENTER,  
FORT WORTH, TEXAS 1991

REVISED MARCH 1991 1004857

U.S. DEPARTMENT OF AGRICULTURE

SOIL CONSERVATION SERVICE

**ANNUAL RUNOFF  
FROM CONCRETE FEEDLOTS (CN-97) AS  
PERCENT OF MEAN MONTHLY PRECIPITATION**  
FIGURE 10C-2



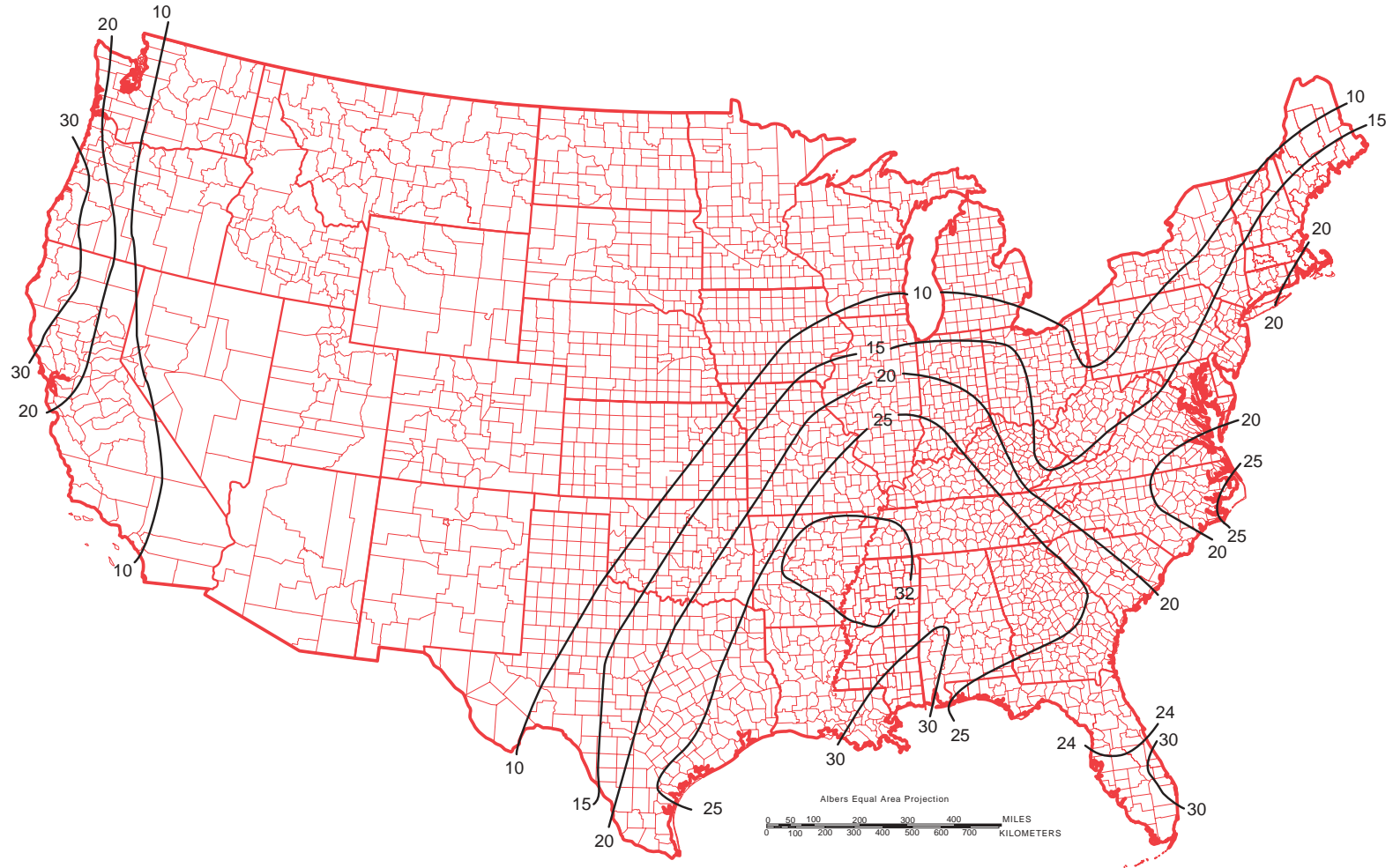
SOURCE:  
DATA PROVIDED BY SCS FIELD PERSONEL. MAP PREPARED USING  
AUTOMATED MAP CONSTRUCTION. NATIONAL CARTOGRAPHIC CENTER,  
FORT WORTH, TEXAS 1991

REVISED MARCH 1991 1004858



### JANUARY RUNOFF FROM UNSURFACED FEEDLOTS (CN-90) AS PERCENT OF MEAN MONTHLY PRECIPITATION

FIGURE 10C-3



SOURCE:  
DATA PROVIDED BY SCS FIELD PERSONEL. MAP PREPARED USING  
AUTOMATED MAP CONSTRUCTION. NATIONAL CARTOGRAPHIC CENTER,  
FORT WORTH, TEXAS 1991

REVISED MARCH 1991 1004857

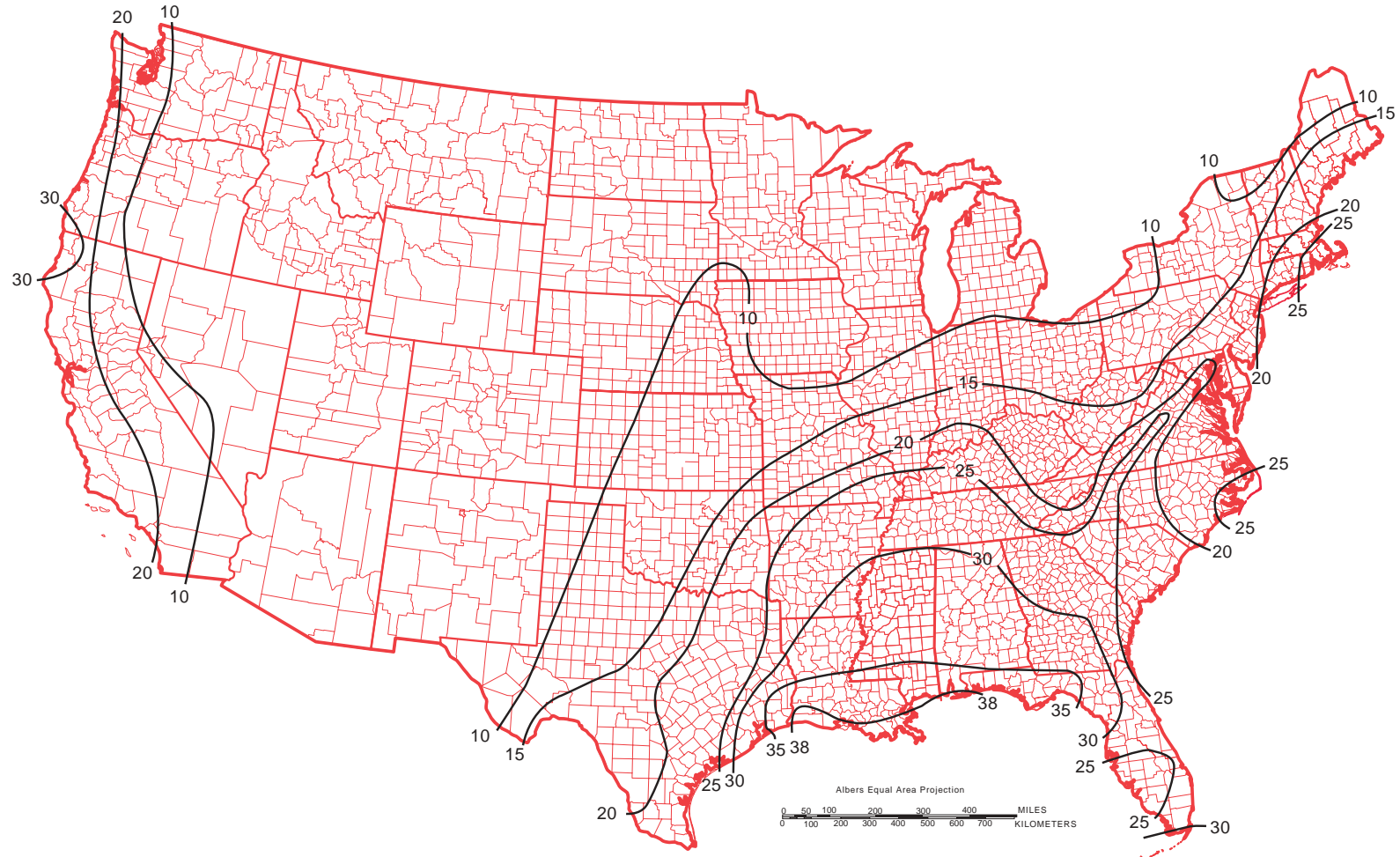
(210-VI-AWMPH, Amend. 31, 4/92)

10C-7

U.S. DEPARTMENT OF AGRICULTURE

SOIL CONSERVATION SERVICE

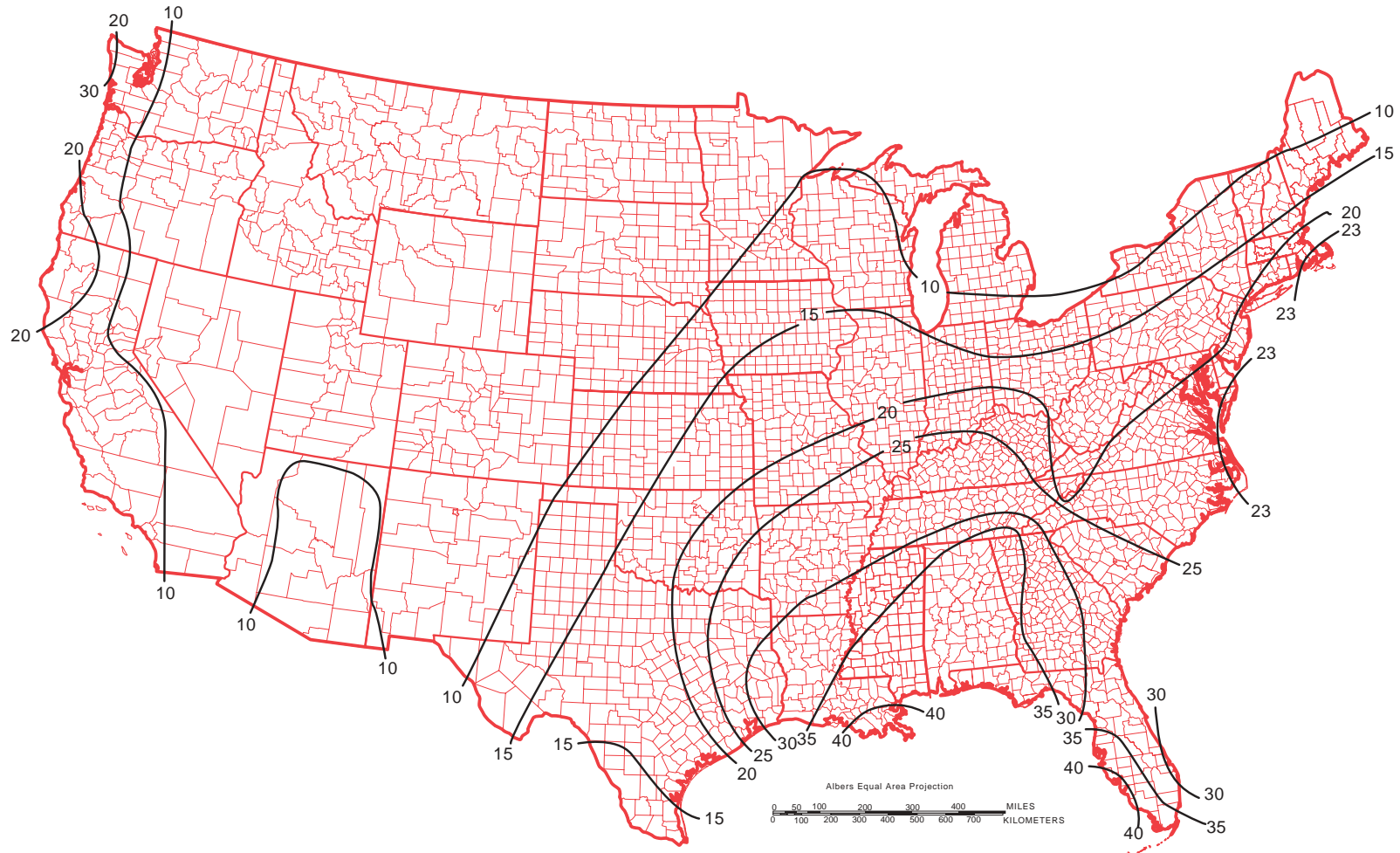
**FEBRUARY RUNOFF  
FROM UNSURFACED FEEDLOTS (CN-90) AS  
PERCENT OF MEAN MONTHLY PRECIPITATION**  
FIGURE 10C-4



SOURCE:  
DATA PROVIDED BY SCS FIELD PERSONEL. MAP PREPARED USING  
AUTOMATED MAP CONSTRUCTION. NATIONAL CARTOGRAPHIC CENTER,  
FORT WORTH, TEXAS 1991

REVISED MARCH 1991 1004857

### MARCH RUNOFF FROM UNSURFACED FEEDLOTS (CN-90) AS PERCENT OF MEAN MONTHLY PRECIPITATION FIGURE 10C-5



SOURCE:  
DATA PROVIDED BY SCS FIELD PERSONEL. MAP PREPARED USING  
AUTOMATED MAP CONSTRUCTION. NATIONAL CARTOGRAPHIC CENTER,  
FORT WORTH, TEXAS 1991

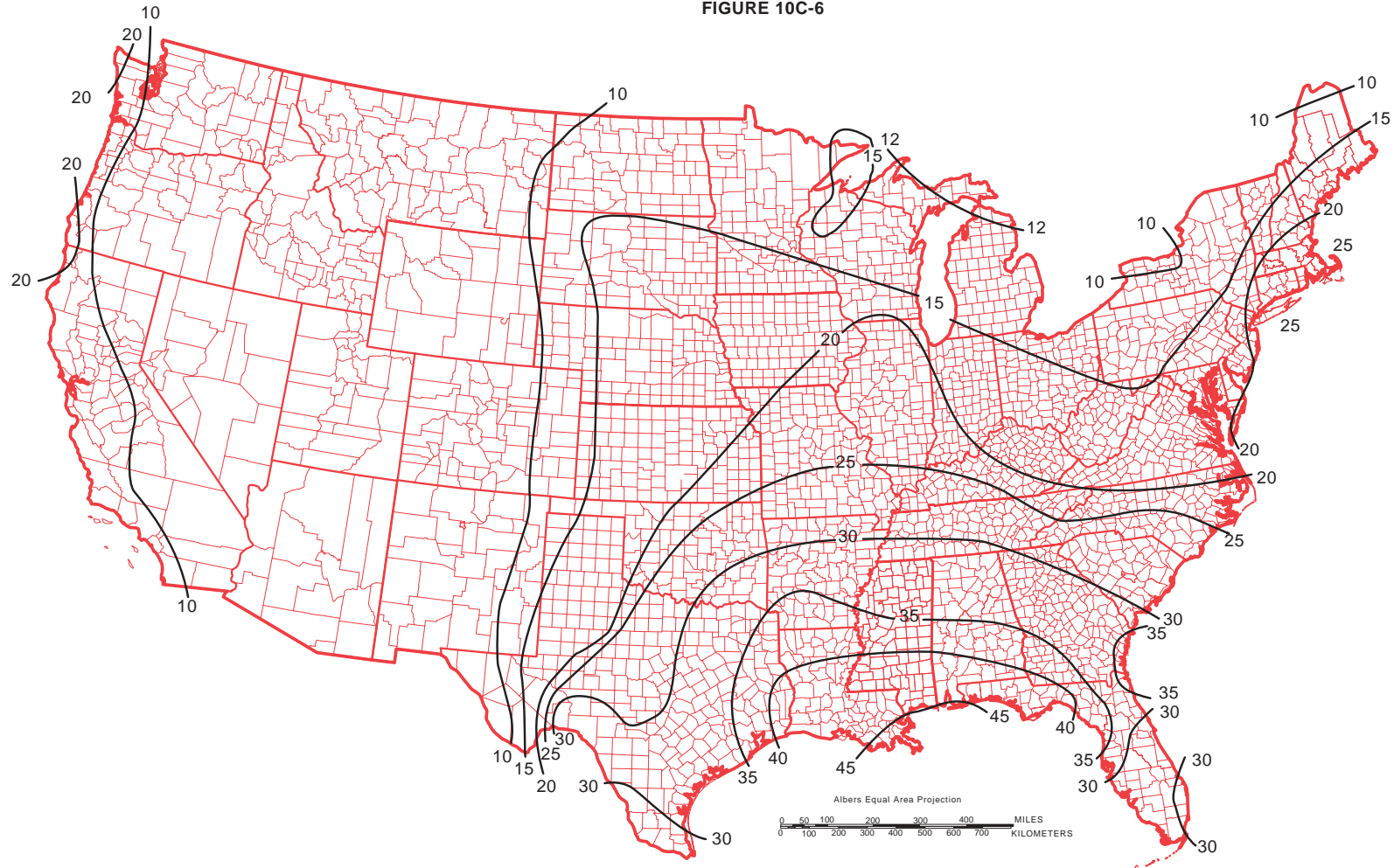
REVISED MARCH 1991 1004857



U.S. DEPARTMENT OF AGRICULTURE

SOIL CONSERVATION SERVICE

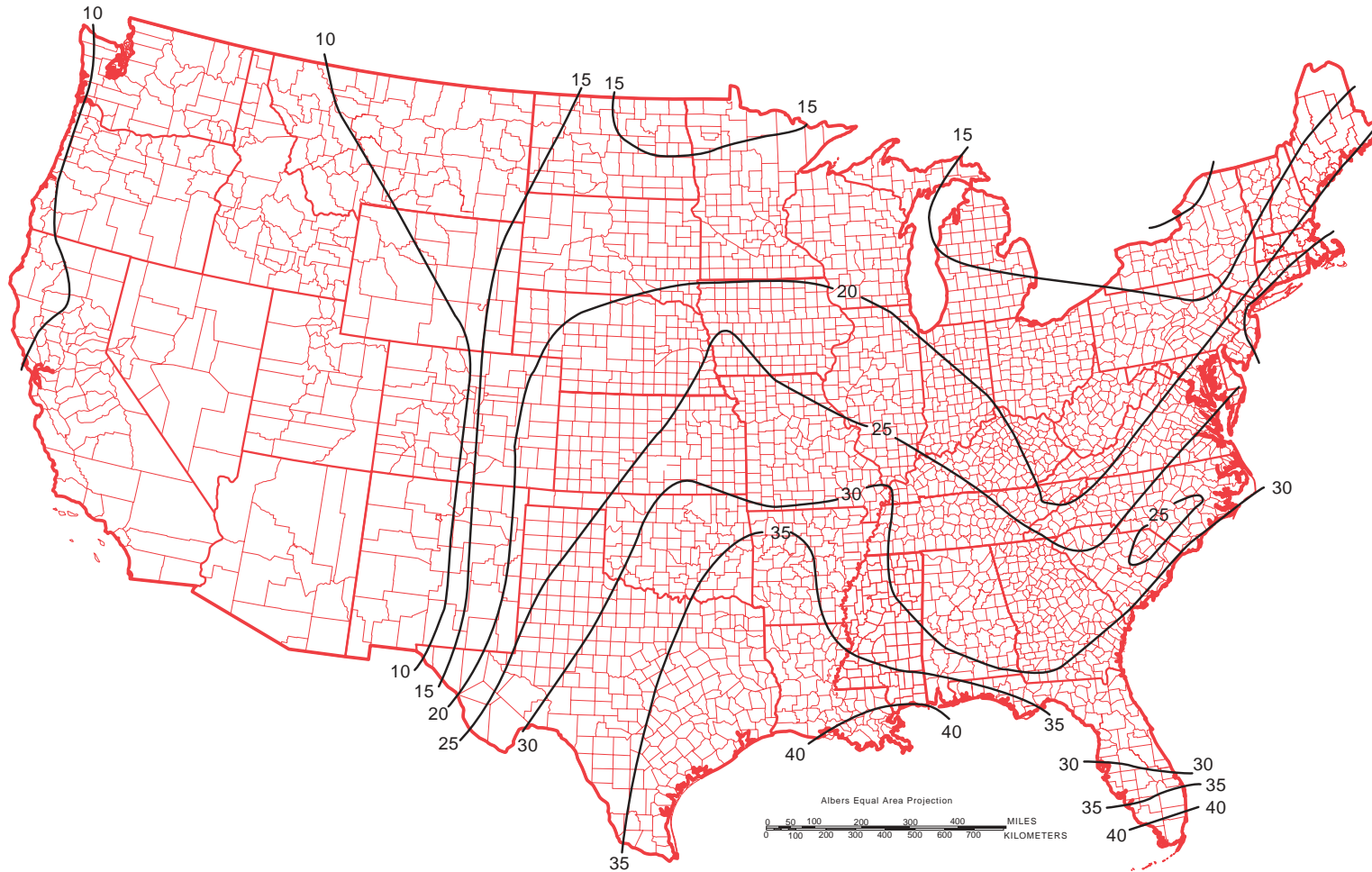
### APRIL RUNOFF FROM UNSURFACED FEEDLOTS (CN-90) AS PERCENT OF MEAN MONTHLY PRECIPITATION FIGURE 10C-6



SOURCE:  
DATA PROVIDED BY SCS FIELD PERSONEL. MAP PREPARED USING  
AUTOMATED MAP CONSTRUCTION. NATIONAL CARTOGRAPHIC CENTER,  
FORT WORTH, TEXAS 1991

REVISED MARCH 1991 1004857

### APRIL RUNOFF FROM UNSURFACED FEEDLOTS (CN-90) AS PERCENT OF MEAN MONTHLY PRECIPITATION FIGURE 10C-7

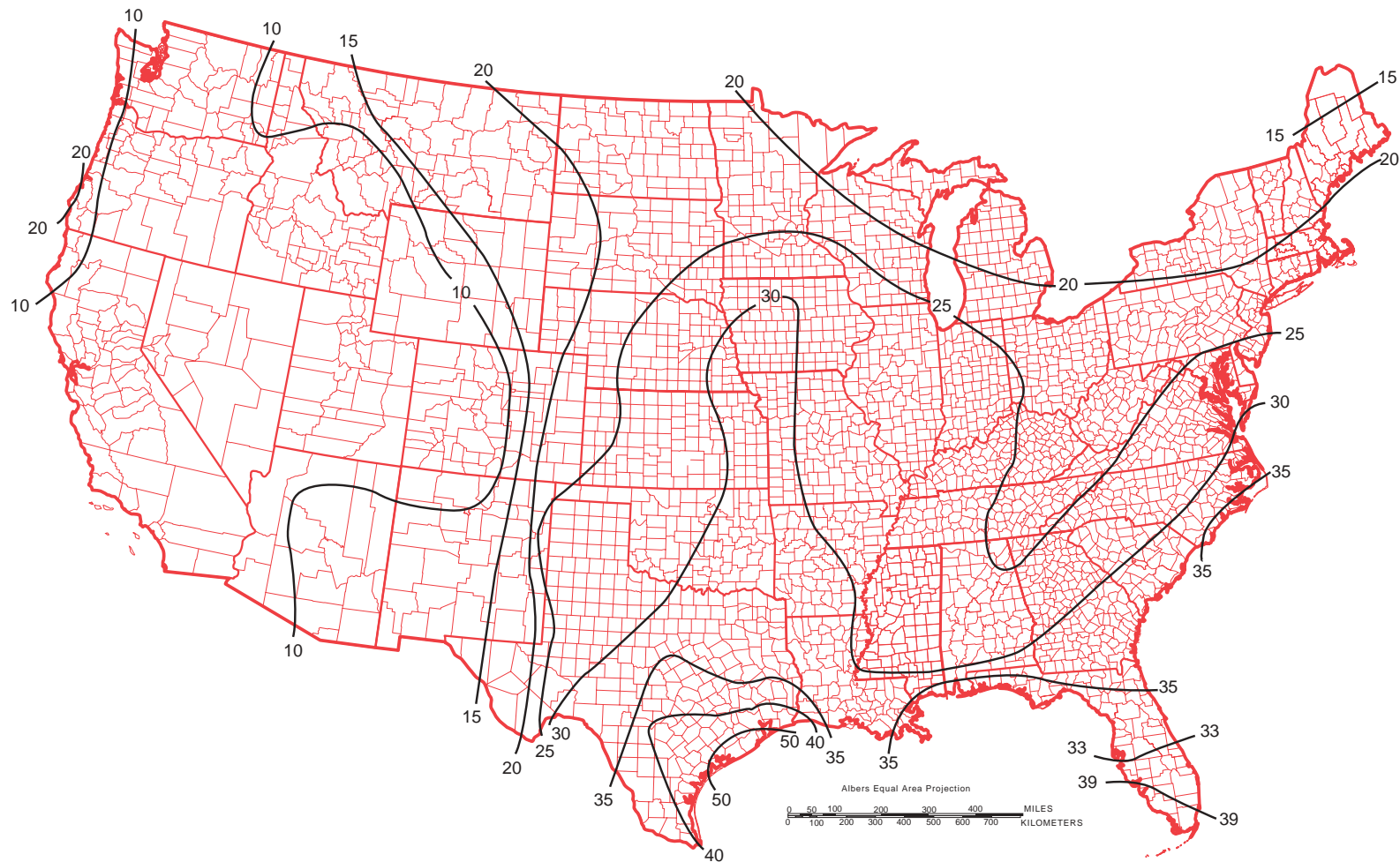


SOURCE:  
DATA PROVIDED BY SCS FIELD PERSONEL. MAP PREPARED USING  
AUTOMATED MAP CONSTRUCTION. NATIONAL CARTOGRAPHIC CENTER,  
FORT WORTH, TEXAS 1991

REVISED MARCH 1991 1004834

### JUNE RUNOFF FROM UNSURFACED FEEDLOTS (CN-90) AS PERCENT OF MEAN MONTHLY PRECIPITATION

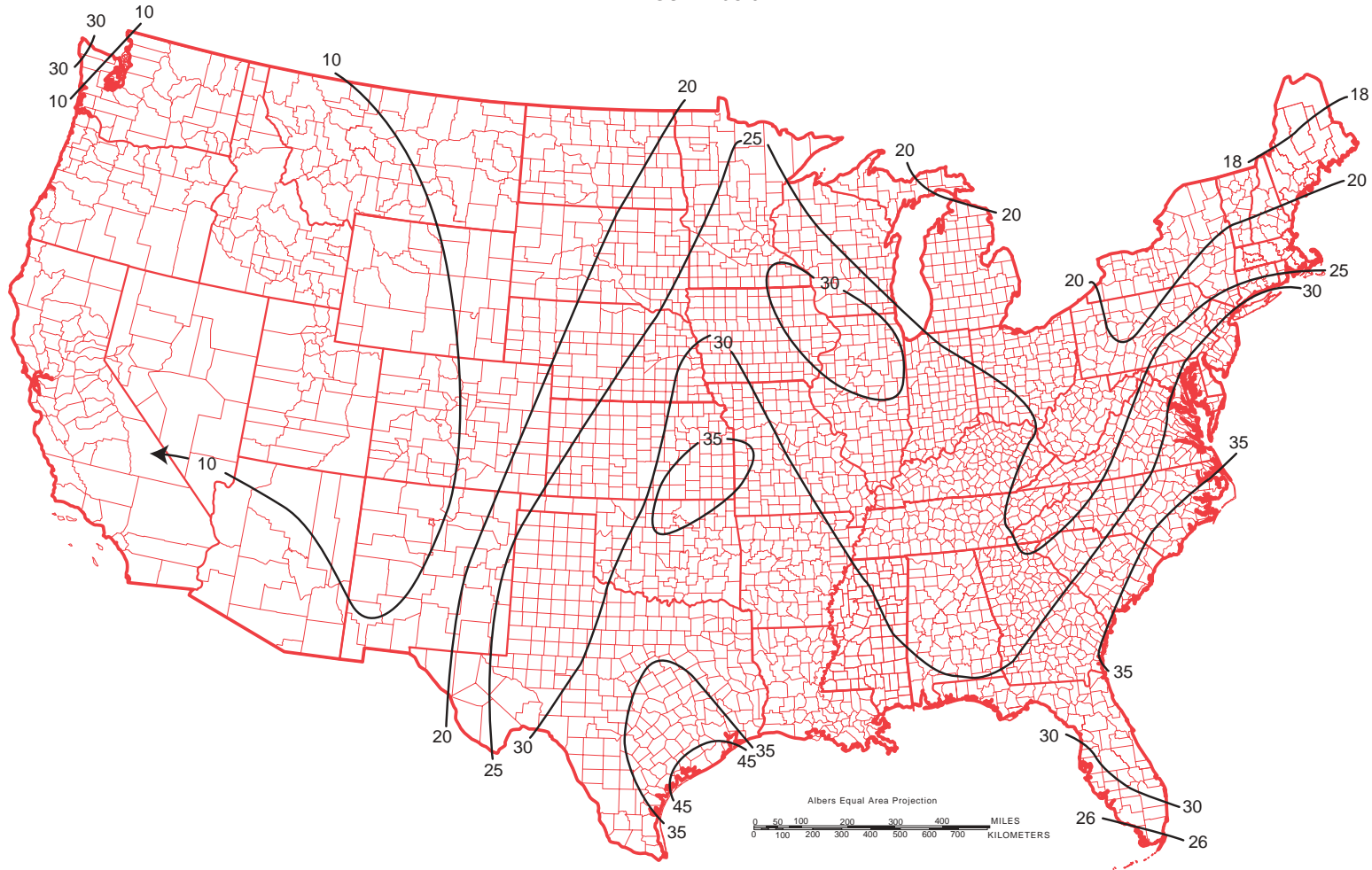
FIGURE 10C-8



SOURCE:  
DATA PROVIDED BY SCS FIELD PERSONEL. MAP PREPARED USING  
AUTOMATED MAP CONSTRUCTION. NATIONAL CARTOGRAPHIC CENTER,  
FORT WORTH, TEXAS 1991

REVISED MARCH 1991 1004835

### JULY RUNOFF FROM UNSURFACED FEEDLOTS (CN-90) AS PERCENT OF MEAN MONTHLY PRECIPITATION FIGURE 10C-9

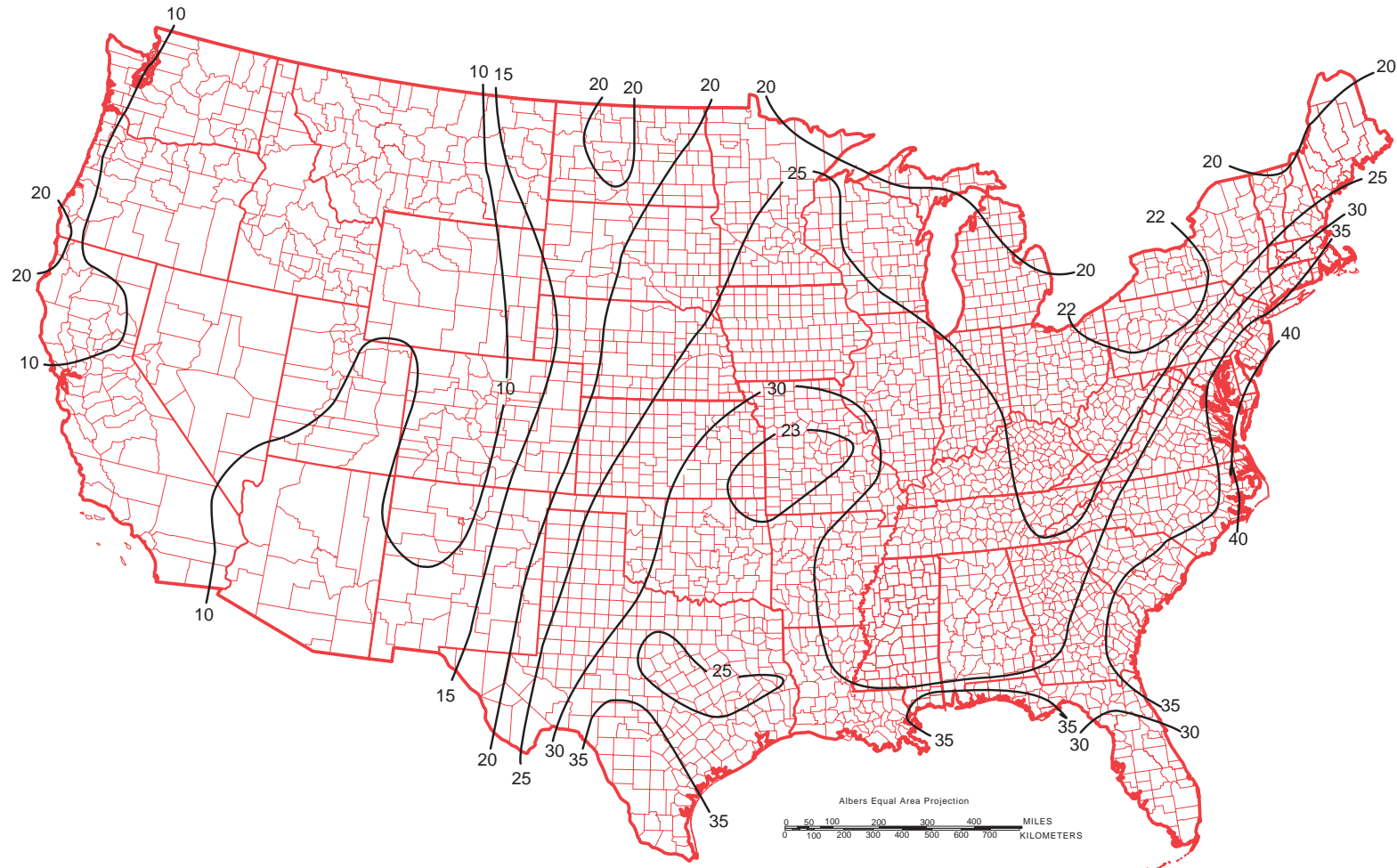


SOURCE:  
DATA PROVIDED BY SCS FIELD PERSONEL. MAP PREPARED USING  
AUTOMATED MAP CONSTRUCTION. NATIONAL CARTOGRAPHIC CENTER,  
FORT WORTH, TEXAS 1991

REVISED MARCH 1991 1004836



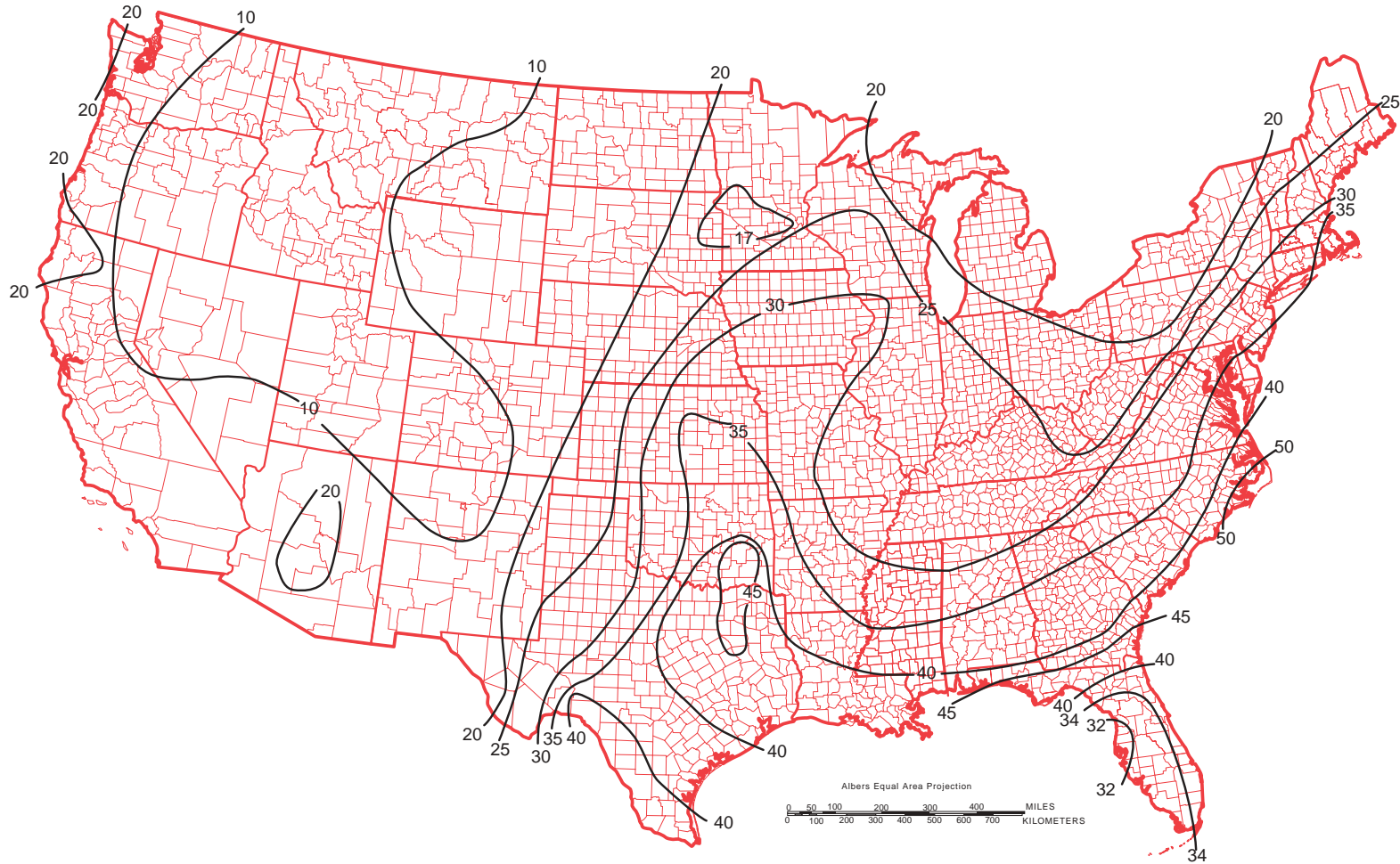
### AUGUST RUNOFF FROM UNSURFACED FEEDLOTS (CN-90) AS PERCENT OF MEAN MONTHLY PRECIPITATION FIGURE 10C-10



SOURCE:  
DATA PROVIDED BY SCS FIELD PERSONEL. MAP PREPARED USING  
AUTOMATED MAP CONSTRUCTION. NATIONAL CARTOGRAPHIC CENTER,  
FORT WORTH, TEXAS 1991

REVISED MARCH 1991 1004828

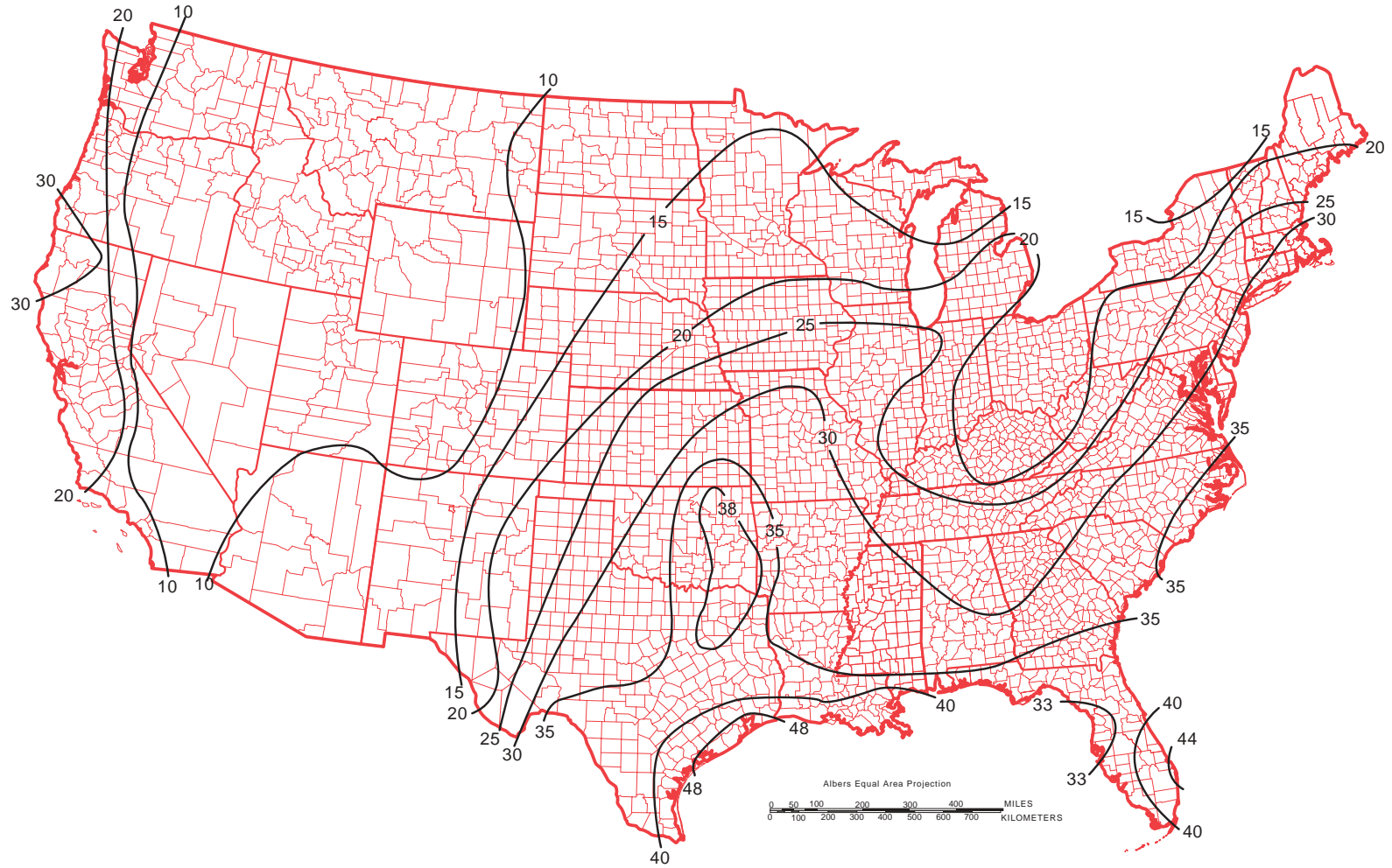
### SEPTEMBER RUNOFF FROM UNSURFACED FEEDLOTS (CN-90) AS PERCENT OF MEAN MONTHLY PRECIPITATION FIGURE 10C-11



SOURCE:  
DATA PROVIDED BY SCS FIELD PERSONEL. MAP PREPARED USING  
AUTOMATED MAP CONSTRUCTION. NATIONAL CARTOGRAPHIC CENTER,  
FORT WORTH, TEXAS 1991

REVISED MARCH 1991 1004837

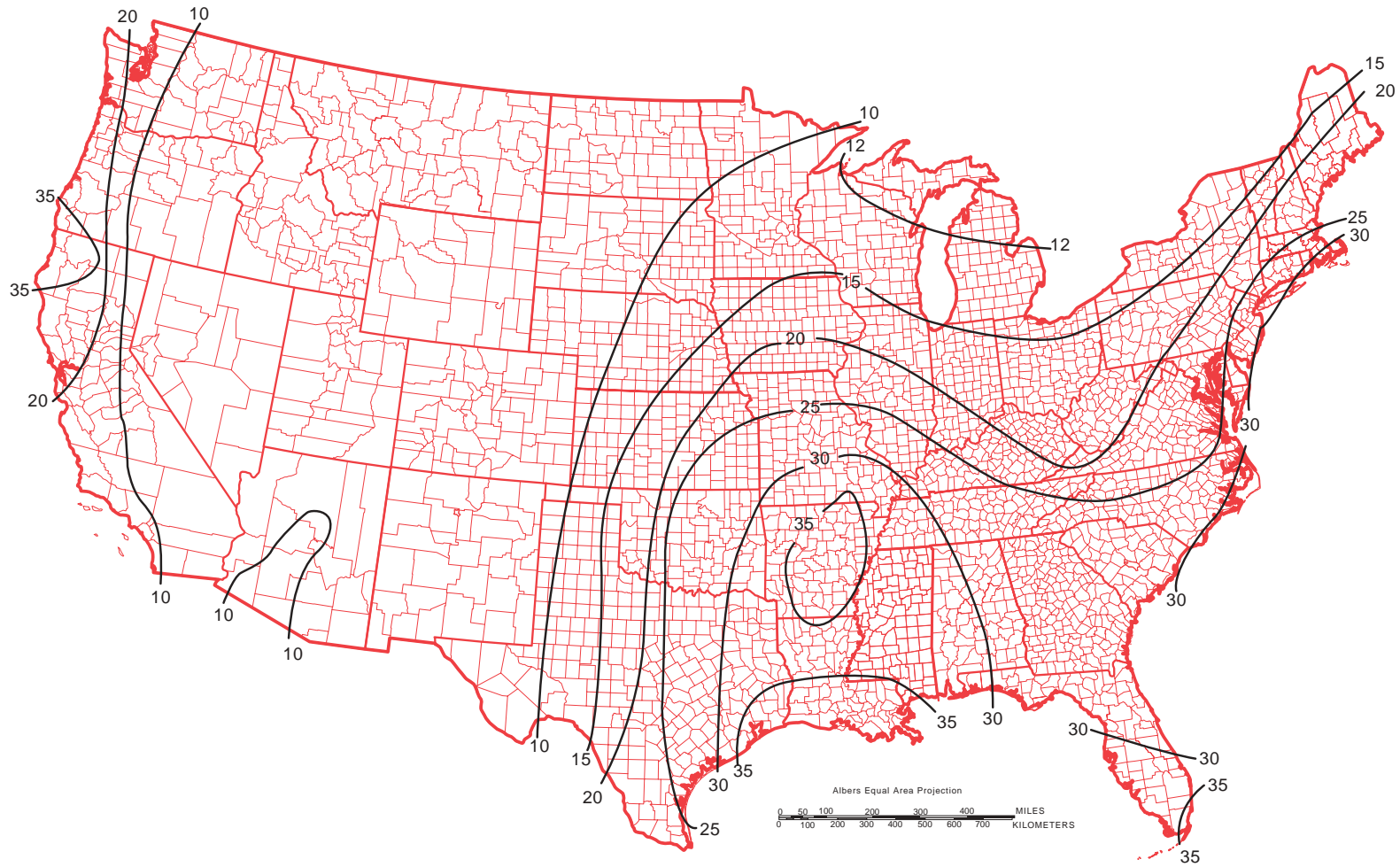
**OCTOBER RUNOFF  
FROM UNSURFACED FEEDLOTS (CN-90) AS  
PERCENT OF MEAN MONTHLY PRECIPITATION**  
FIGURE 10C-12



SOURCE:  
DATA PROVIDED BY SCS FIELD PERSONEL. MAP PREPARED USING  
AUTOMATED MAP CONSTRUCTION. NATIONAL CARTOGRAPHIC CENTER,  
FORT WORTH, TEXAS 1991

REVISED MARCH 1991 1004838

### NOVEMBER RUNOFF FROM UNSURFACED FEEDLOTS (CN-90) AS PERCENT OF MEAN MONTHLY PRECIPITATION FIGURE 10C-13



SOURCE:  
DATA PROVIDED BY SCS FIELD PERSONEL. MAP PREPARED USING  
AUTOMATED MAP CONSTRUCTION. NATIONAL CARTOGRAPHIC CENTER,  
FORT WORTH, TEXAS 1991

REVISED MARCH 1991 1004839

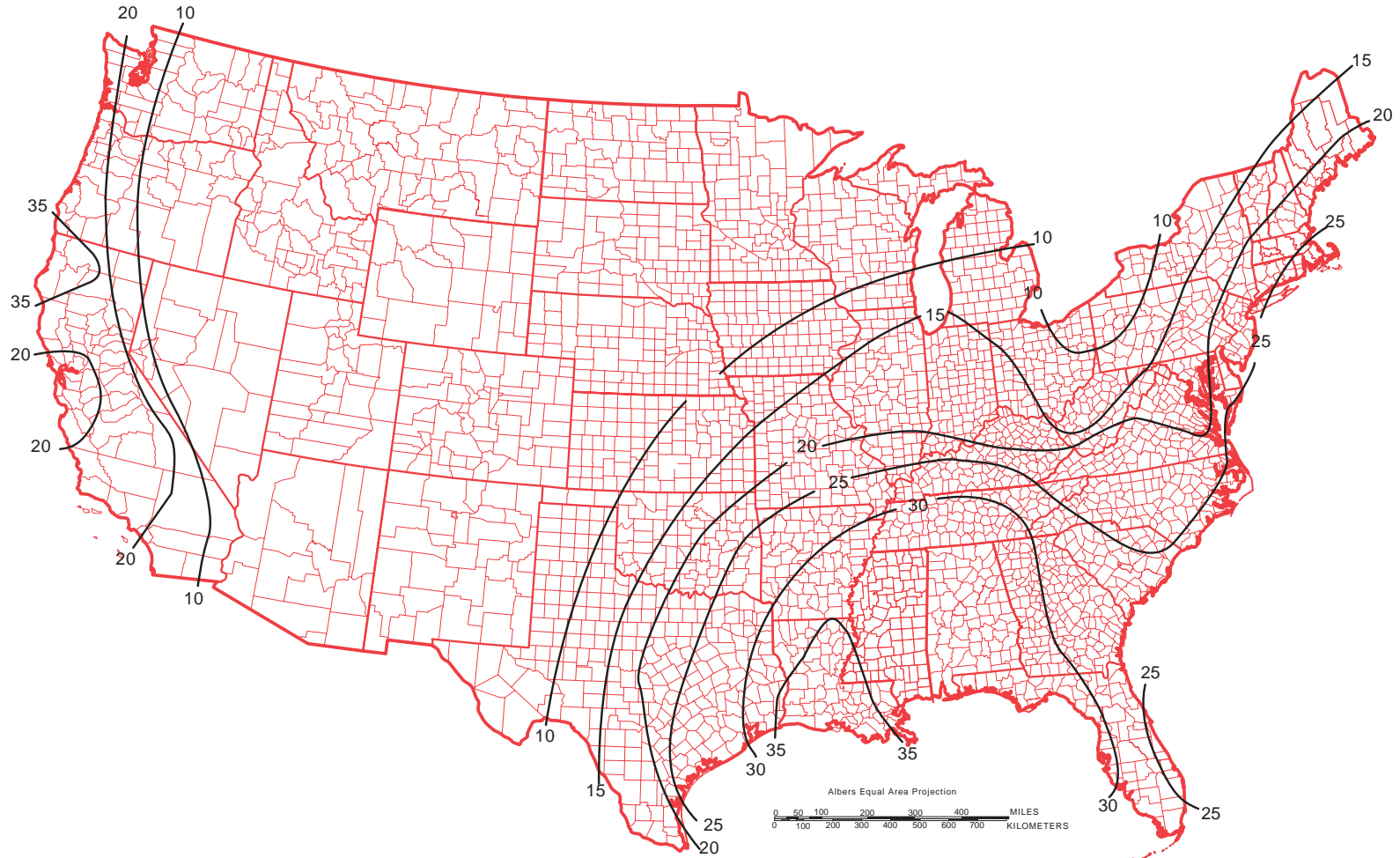


U.S. DEPARTMENT OF AGRICULTURE

SOIL CONSERVATION SERVICE

### DECEMBER RUNOFF FROM UNSURFACED FEEDLOTS (CN-90) AS PERCENT OF MEAN MONTHLY PRECIPITATION

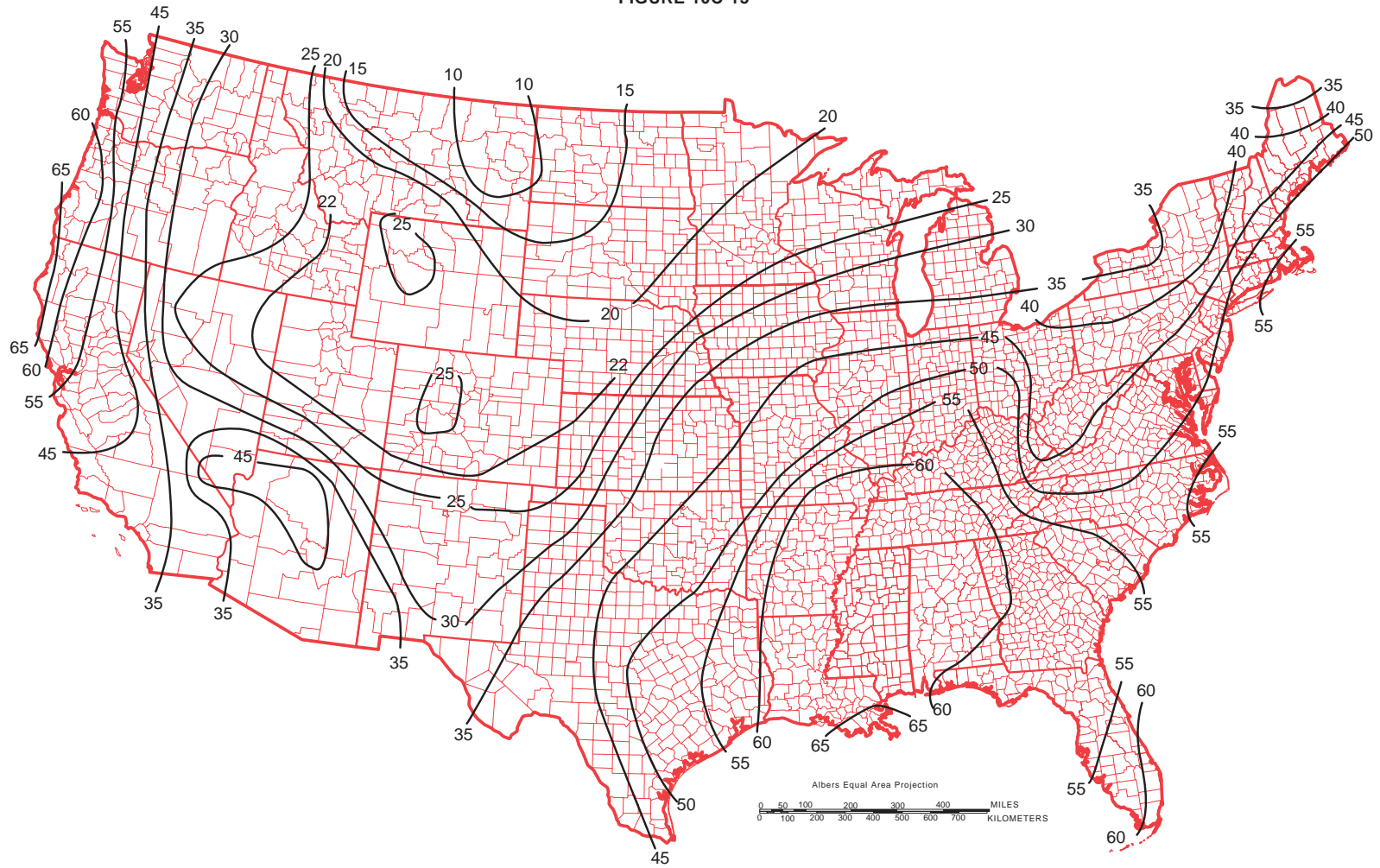
FIGURE 10C-14



SOURCE:  
DATA PROVIDED BY SCS FIELD PERSONEL. MAP PREPARED USING  
AUTOMATED MAP CONSTRUCTION. NATIONAL CARTOGRAPHIC CENTER,  
FORT WORTH, TEXAS 1991

REVISED MARCH 1991 1004840

### JANUARY RUNOFF FROM CONCRETE FEEDLOTS (CN-97) AS PERCENT OF MEAN MONTHLY PRECIPITATION FIGURE 10C-15



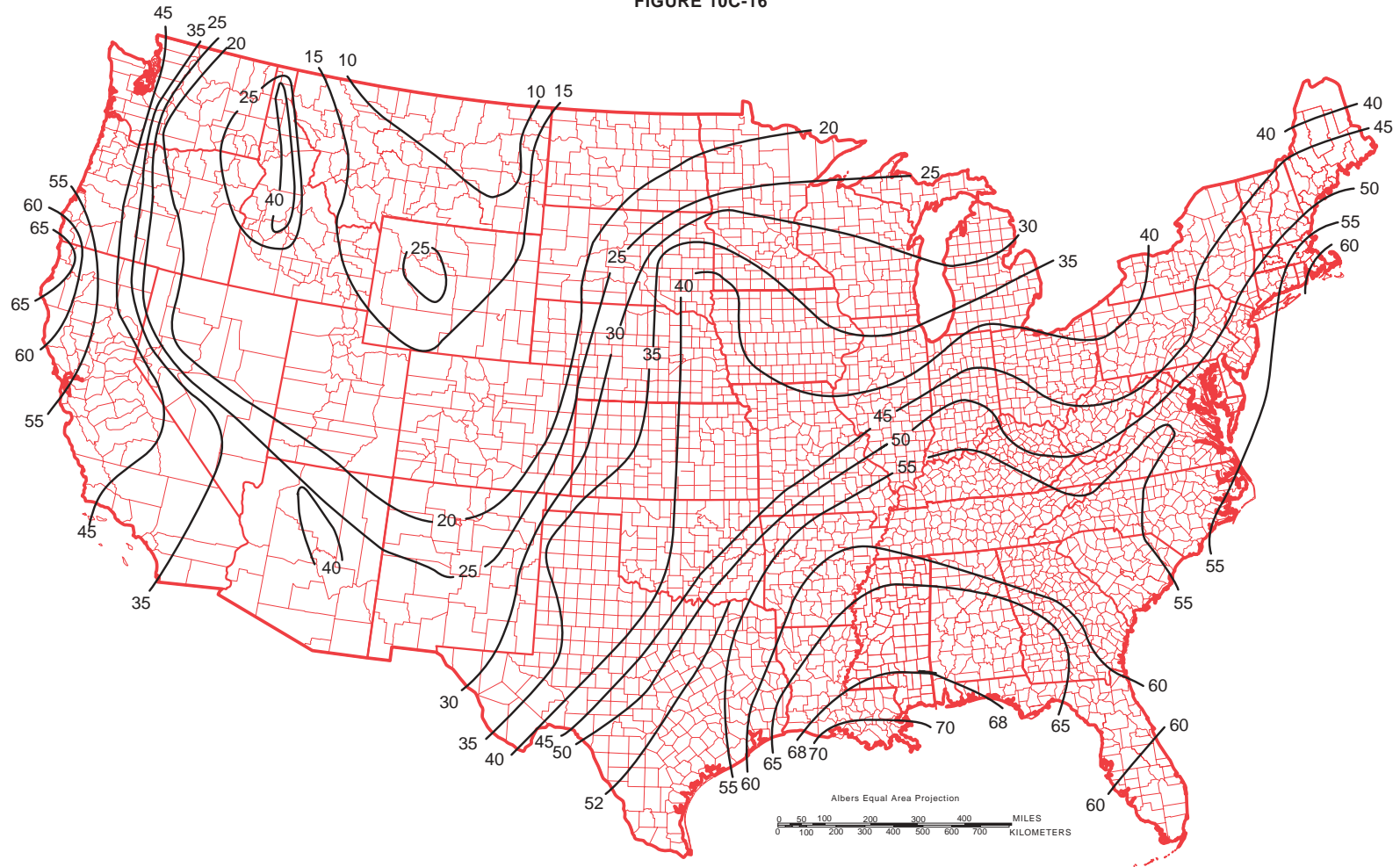
SOURCE:  
DATA PROVIDED BY SCS FIELD PERSONEL. MAP PREPARED USING  
AUTOMATED MAP CONSTRUCTION. NATIONAL CARTOGRAPHIC CENTER,  
FORT WORTH, TEXAS 1991

REVISED MARCH 1991 1004841

U.S. DEPARTMENT OF AGRICULTURE

SOIL CONSERVATION SERVICE

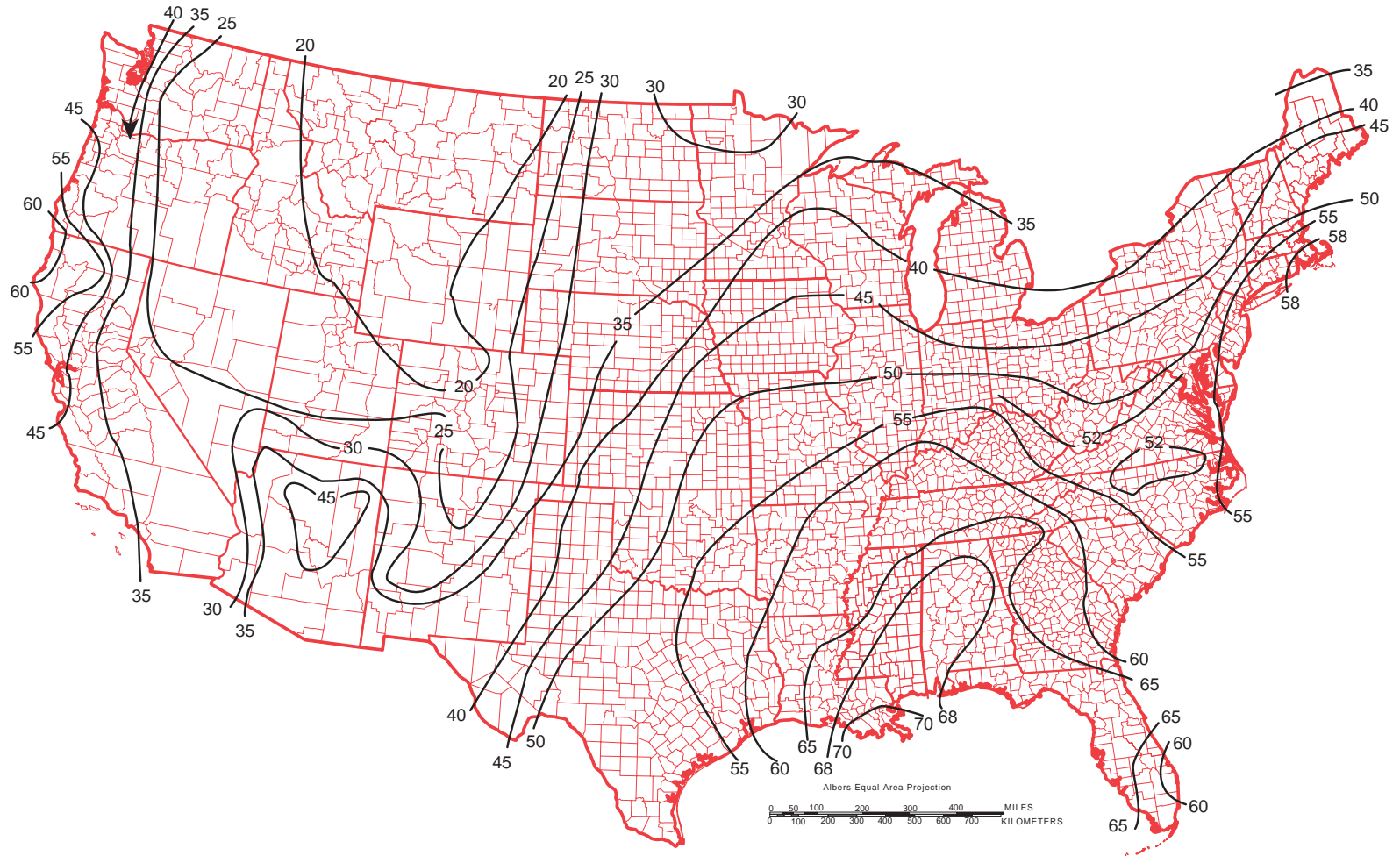
**FEBRUARY RUNOFF  
FROM CONCRETE FEEDLOTS (CN-97) AS  
PERCENT OF MEAN MONTHLY PRECIPITATION**  
FIGURE 10C-16



SOURCE:  
DATA PROVIDED BY SCS FIELD PERSONEL. MAP PREPARED USING  
AUTOMATED MAP CONSTRUCTION. NATIONAL CARTOGRAPHIC CENTER,  
FORT WORTH, TEXAS 1991

REVISED MARCH 1991 1004842

### MARCH RUNOFF FROM CONCRETE FEEDLOTS (CN-97) AS PERCENT OF MEAN MONTHLY PRECIPITATION FIGURE 10C-17



SOURCE:  
DATA PROVIDED BY SCS FIELD PERSONEL. MAP PREPARED USING  
AUTOMATED MAP CONSTRUCTION. NATIONAL CARTOGRAPHIC CENTER,  
FORT WORTH, TEXAS 1991

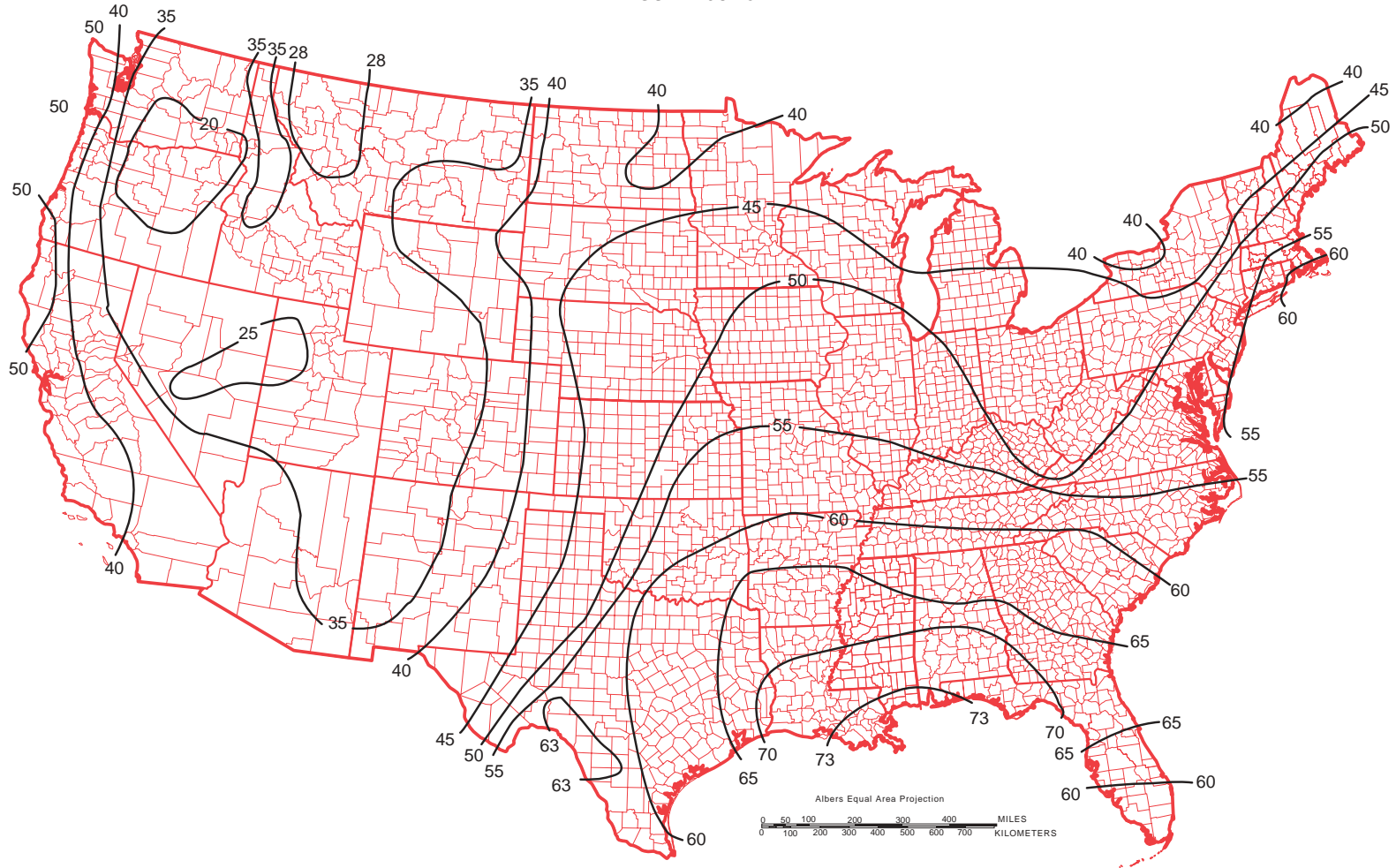
REVISED MARCH 1991 1004843



U.S. DEPARTMENT OF AGRICULTURE

SOIL CONSERVATION SERVICE

**APRIL RUNOFF  
FROM CONCRETE FEEDLOTS (CN-97) AS  
PERCENT OF MEAN MONTHLY PRECIPITATION**  
FIGURE 10C-18

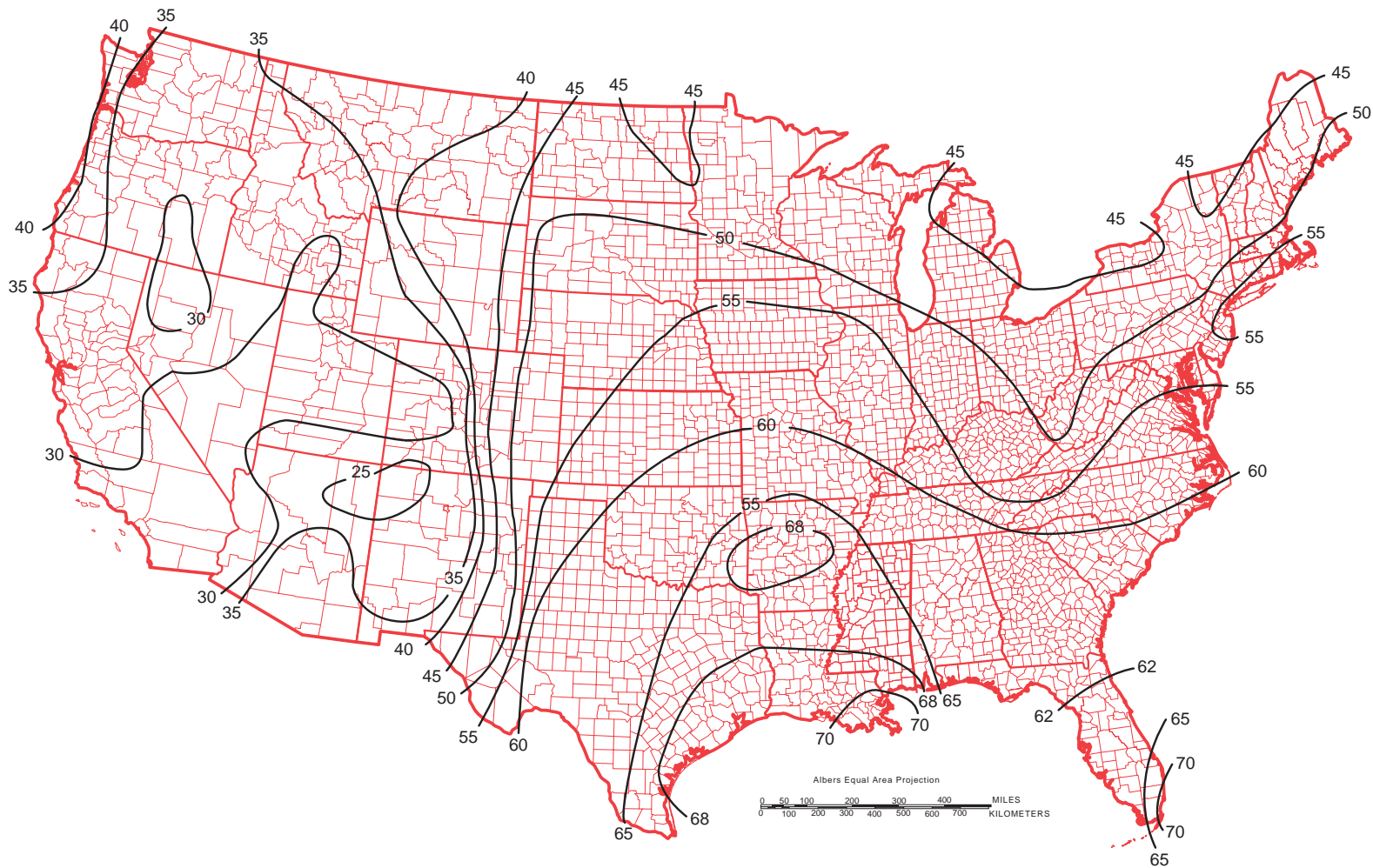


SOURCE:  
DATA PROVIDED BY SCS FIELD PERSONEL. MAP PREPARED USING  
AUTOMATED MAP CONSTRUCTION. NATIONAL CARTOGRAPHIC CENTER,  
FORT WORTH, TEXAS 1991

REVISED MARCH 1991 1004844

### MAY RUNOFF FROM CONCRETE FEEDLOTS (CN-97) AS PERCENT OF MEAN MONTHLY PRECIPITATION

FIGURE 10C-19



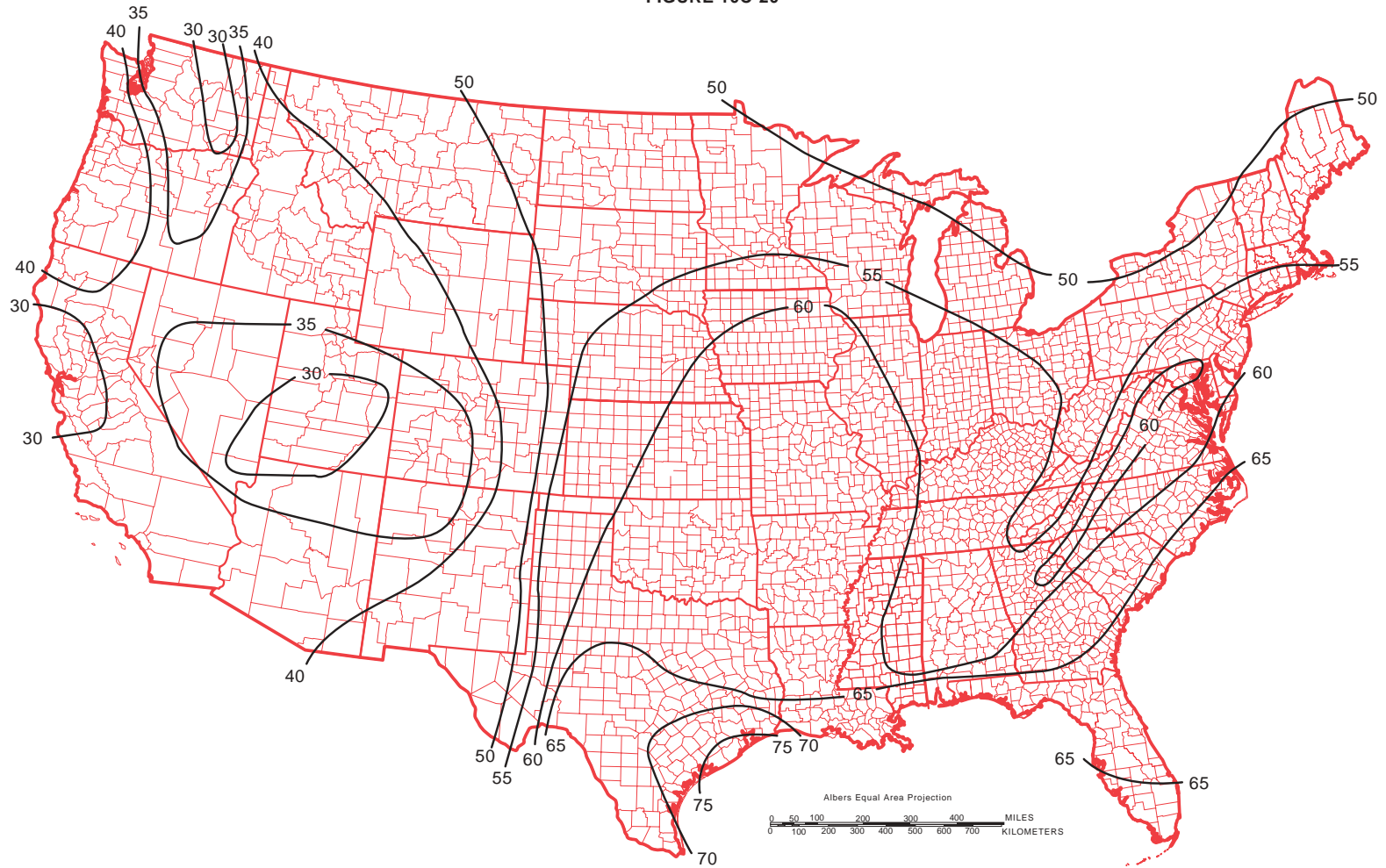
SOURCE:  
DATA PROVIDED BY SCS FIELD PERSONEL. MAP PREPARED USING  
AUTOMATED MAP CONSTRUCTION. NATIONAL CARTOGRAPHIC CENTER,  
FORT WORTH, TEXAS 1991

REVISED MARCH 1991 1004844

U.S. DEPARTMENT OF AGRICULTURE

SOIL CONSERVATION SERVICE

**JUNE RUNOFF  
FROM CONCRETE FEEDLOTS (CN-97) AS  
PERCENT OF MEAN MONTHLY PRECIPITATION**  
FIGURE 10C-20

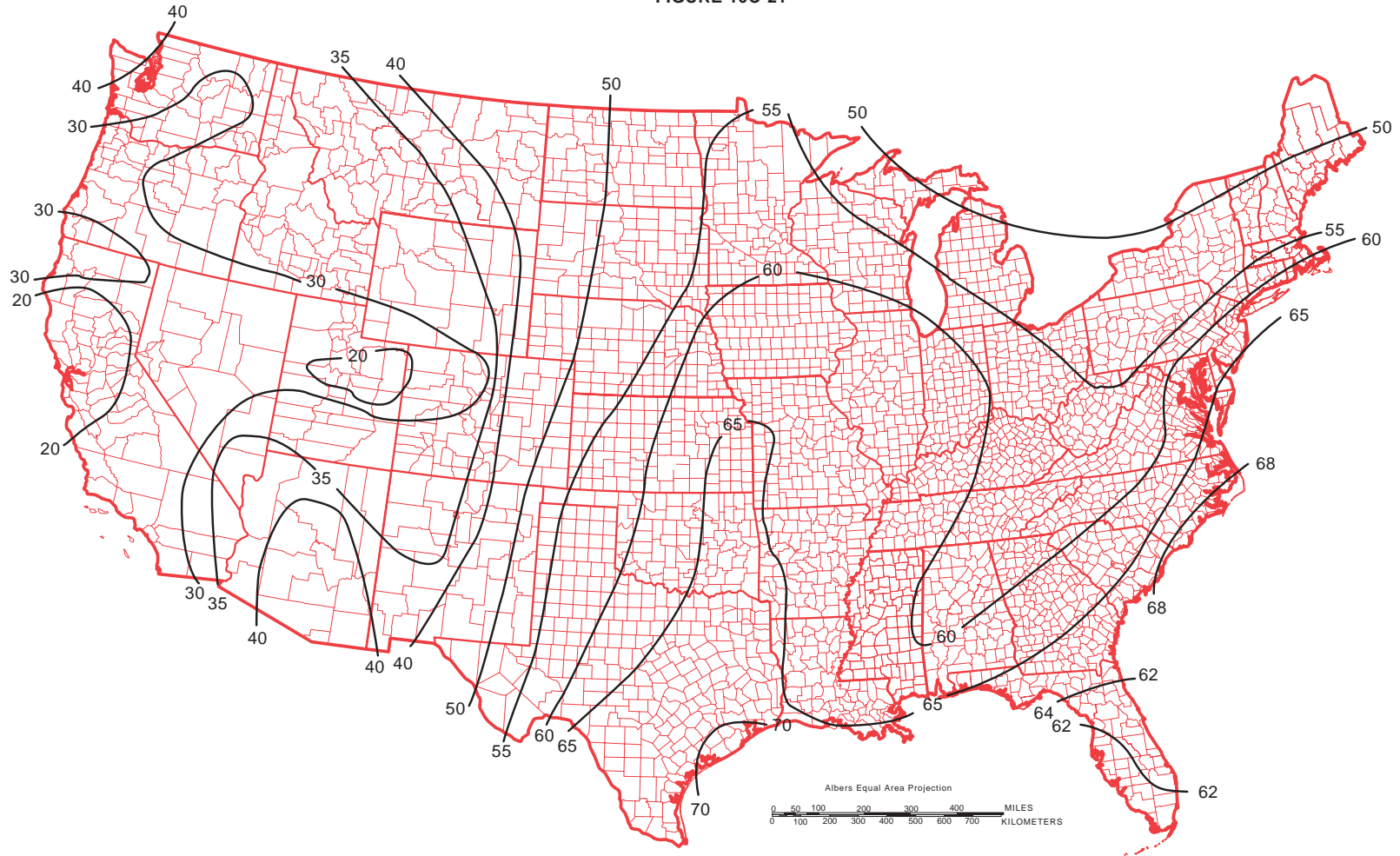


Albers Equal Area Projection  
0 50 100 200 300 400 MILES  
0 100 200 300 400 500 600 700 KILOMETERS

SOURCE:  
DATA PROVIDED BY SCS FIELD PERSONEL. MAP PREPARED USING  
AUTOMATED MAP CONSTRUCTION. NATIONAL CARTOGRAPHIC CENTER,  
FORT WORTH, TEXAS 1991

REVISED MARCH 1991 1004846

### JULY RUNOFF FROM CONCRETE FEEDLOTS (CN-97) AS PERCENT OF MEAN MONTHLY PRECIPITATION FIGURE 10C-21



SOURCE:  
DATA PROVIDED BY SCS FIELD PERSONEL. MAP PREPARED USING  
AUTOMATED MAP CONSTRUCTION. NATIONAL CARTOGRAPHIC CENTER,  
FORT WORTH, TEXAS 1991

REVISED MARCH 1991 1004847

(210-VI-AWMMFH, Amend. 31, 4/92)

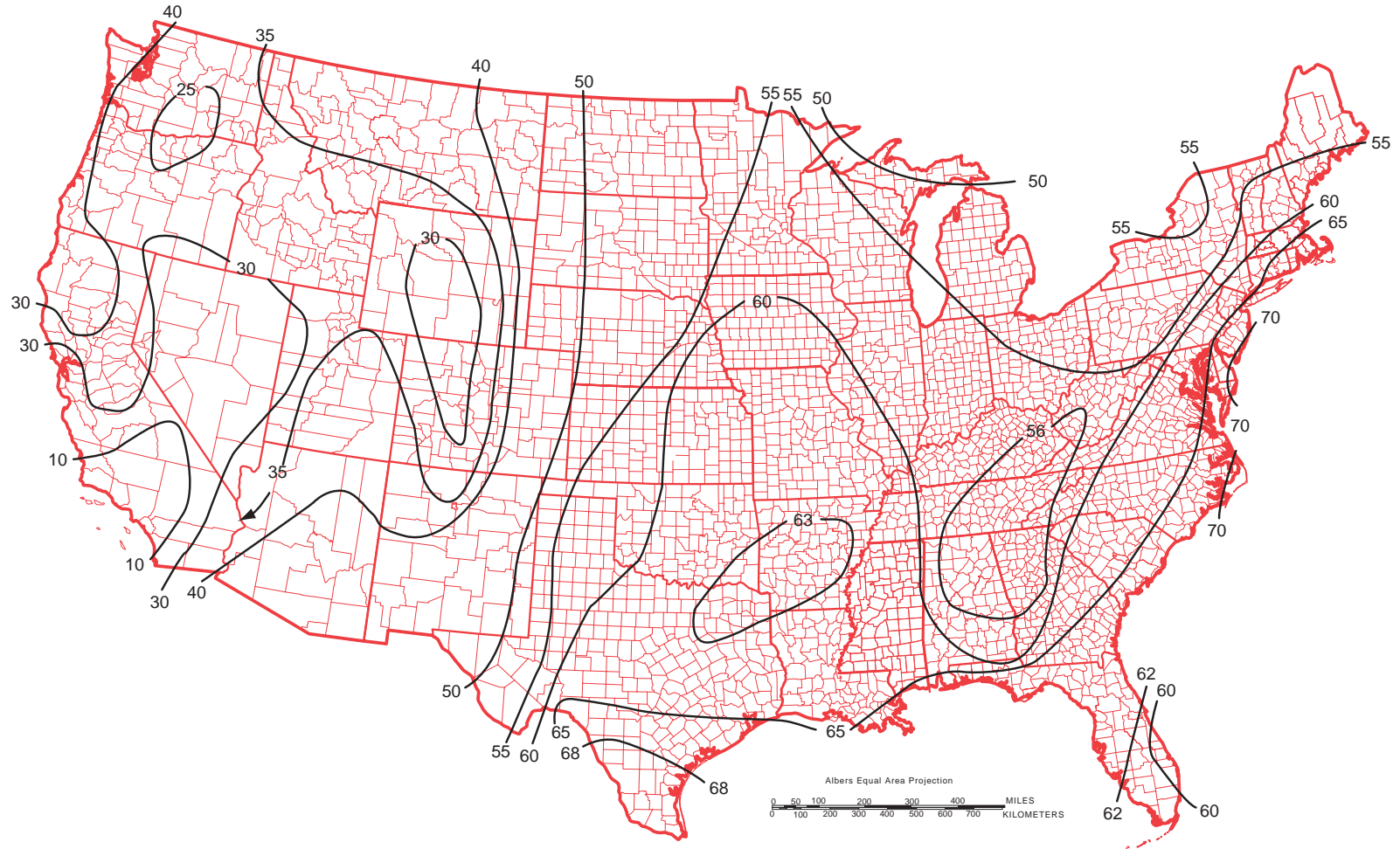
10C-25



U.S. DEPARTMENT OF AGRICULTURE

SOIL CONSERVATION SERVICE

**AUGUST RUNOFF  
FROM CONCRETE FEEDLOTS (CN-97) AS  
PERCENT OF MEAN MONTHLY PRECIPITATION**  
FIGURE 10C-22

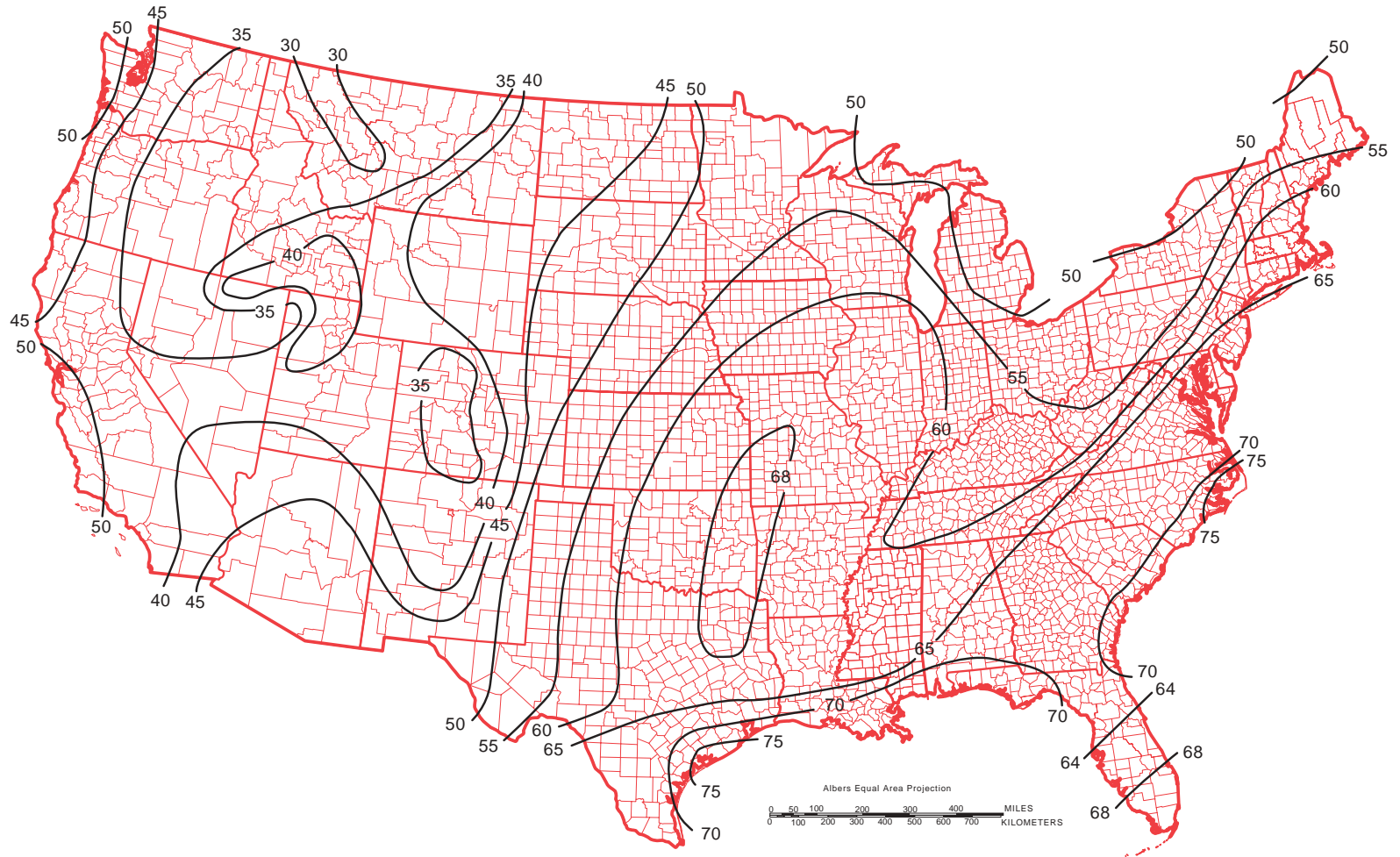


SOURCE:  
DATA PROVIDED BY SCS FIELD PERSONEL. MAP PREPARED USING  
AUTOMATED MAP CONSTRUCTION. NATIONAL CARTOGRAPHIC CENTER,  
FORT WORTH, TEXAS 1991

REVISED MARCH 1991 1004848

### SEPTEMBER RUNOFF FROM CONCRETE FEEDLOTS (CN-97) AS PERCENT OF MEAN MONTHLY PRECIPITATION

FIGURE 10C-23



SOURCE:  
DATA PROVIDED BY SCS FIELD PERSONEL. MAP PREPARED USING  
AUTOMATED MAP CONSTRUCTION. NATIONAL CARTOGRAPHIC CENTER,  
FORT WORTH, TEXAS 1991

REVISED MARCH 1991 1004849

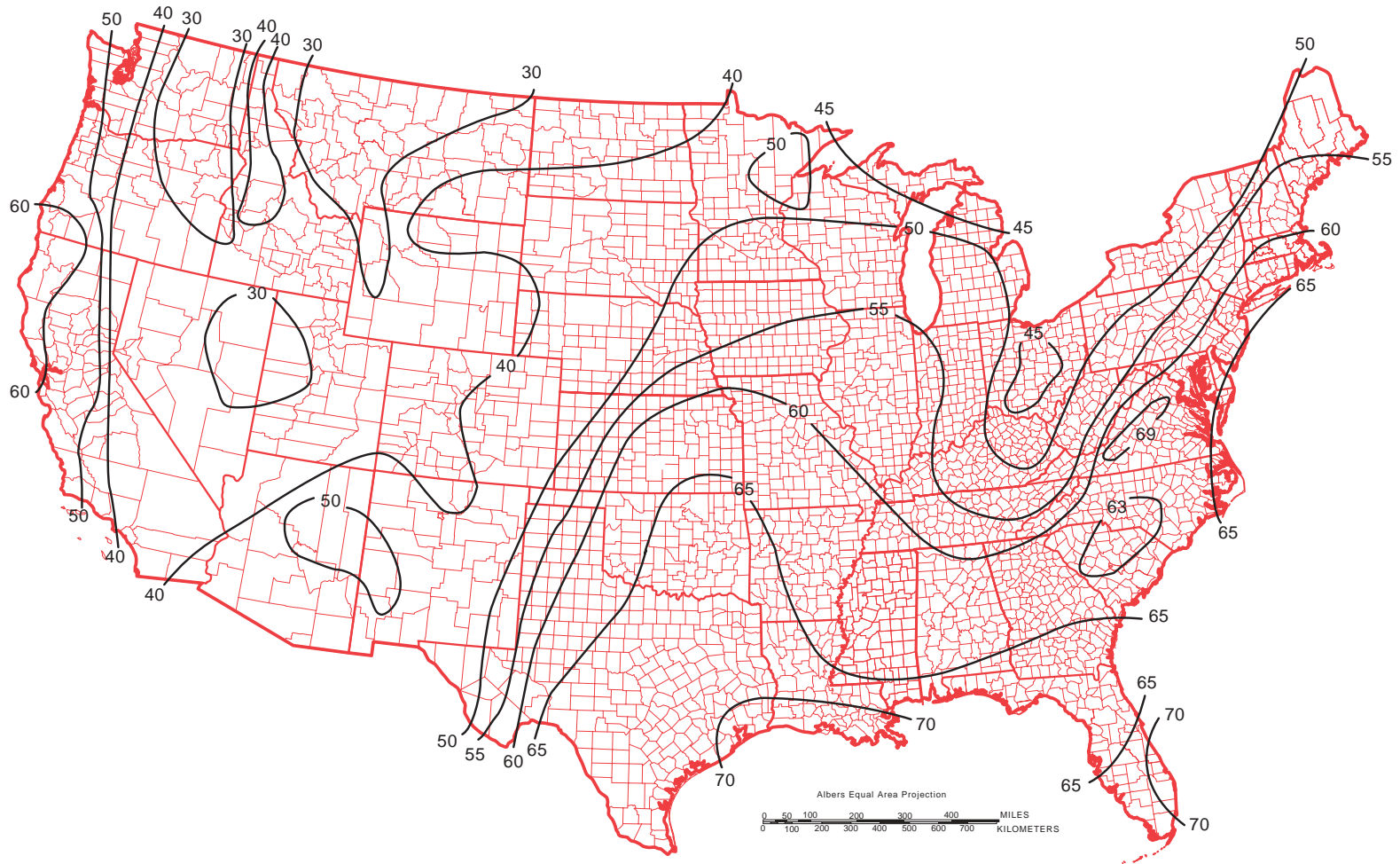
(210-VI-A-WMFF, Amend. 31, 4/92)

10C-27

U.S. DEPARTMENT OF AGRICULTURE

SOIL CONSERVATION SERVICE

**OCTOBER RUNOFF  
FROM CONCRETE FEEDLOTS (CN-97) AS  
PERCENT OF MEAN MONTHLY PRECIPITATION**  
FIGURE 10C-24

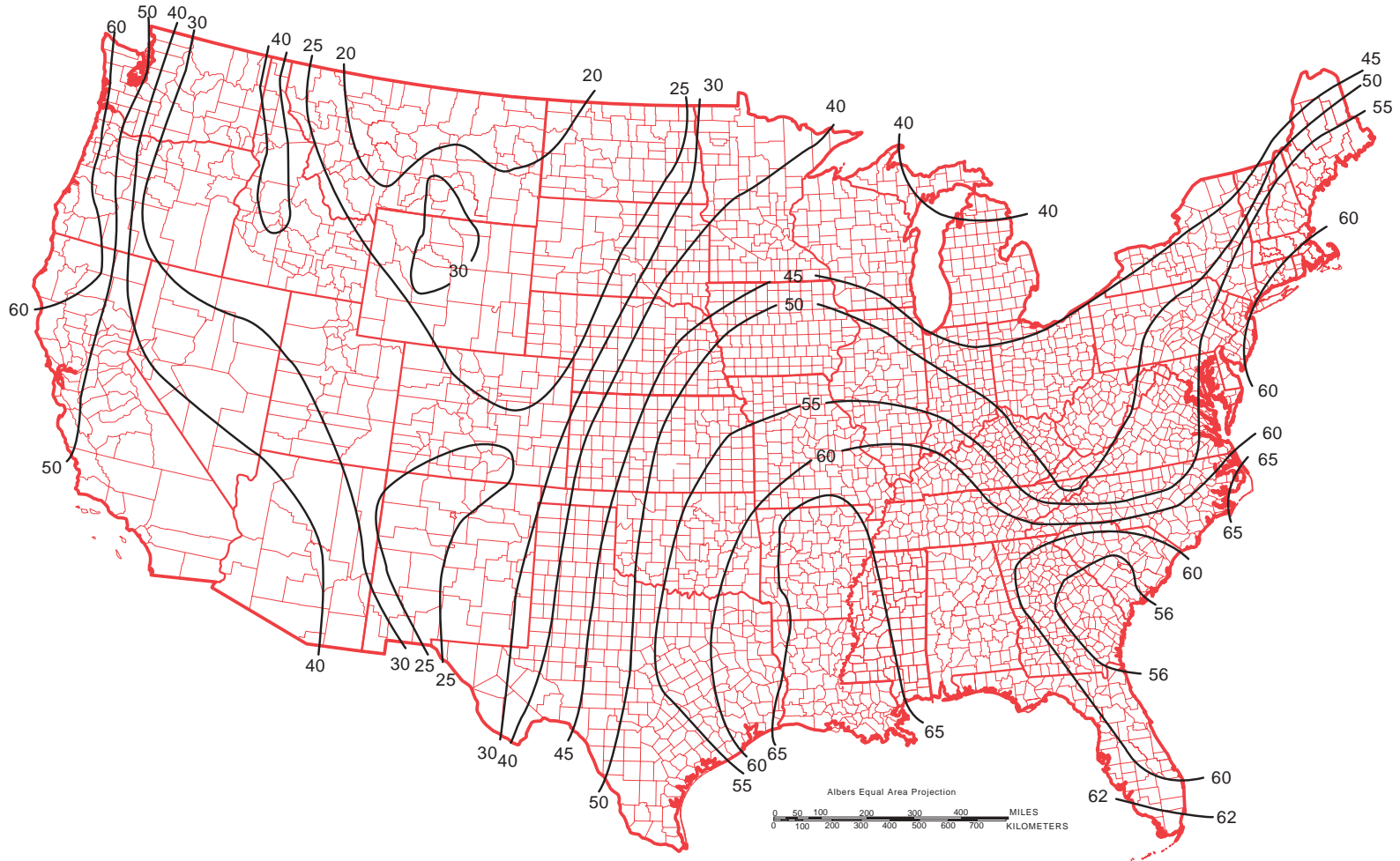


SOURCE:  
DATA PROVIDED BY SCS FIELD PERSONEL. MAP PREPARED USING  
AUTOMATED MAP CONSTRUCTION. NATIONAL CARTOGRAPHIC CENTER,  
FORT WORTH, TEXAS 1991

REVISED MARCH 1991 1004850

### NOVEMBER RUNOFF FROM CONCRETE FEEDLOTS (CN-97) AS PERCENT OF MEAN MONTHLY PRECIPITATION

FIGURE 10C-25



SOURCE:  
DATA PROVIDED BY SCS FIELD PERSONEL. MAP PREPARED USING  
AUTOMATED MAP CONSTRUCTION. NATIONAL CARTOGRAPHIC CENTER,  
FORT WORTH, TEXAS 1991

REVISED MARCH 1991 1004851

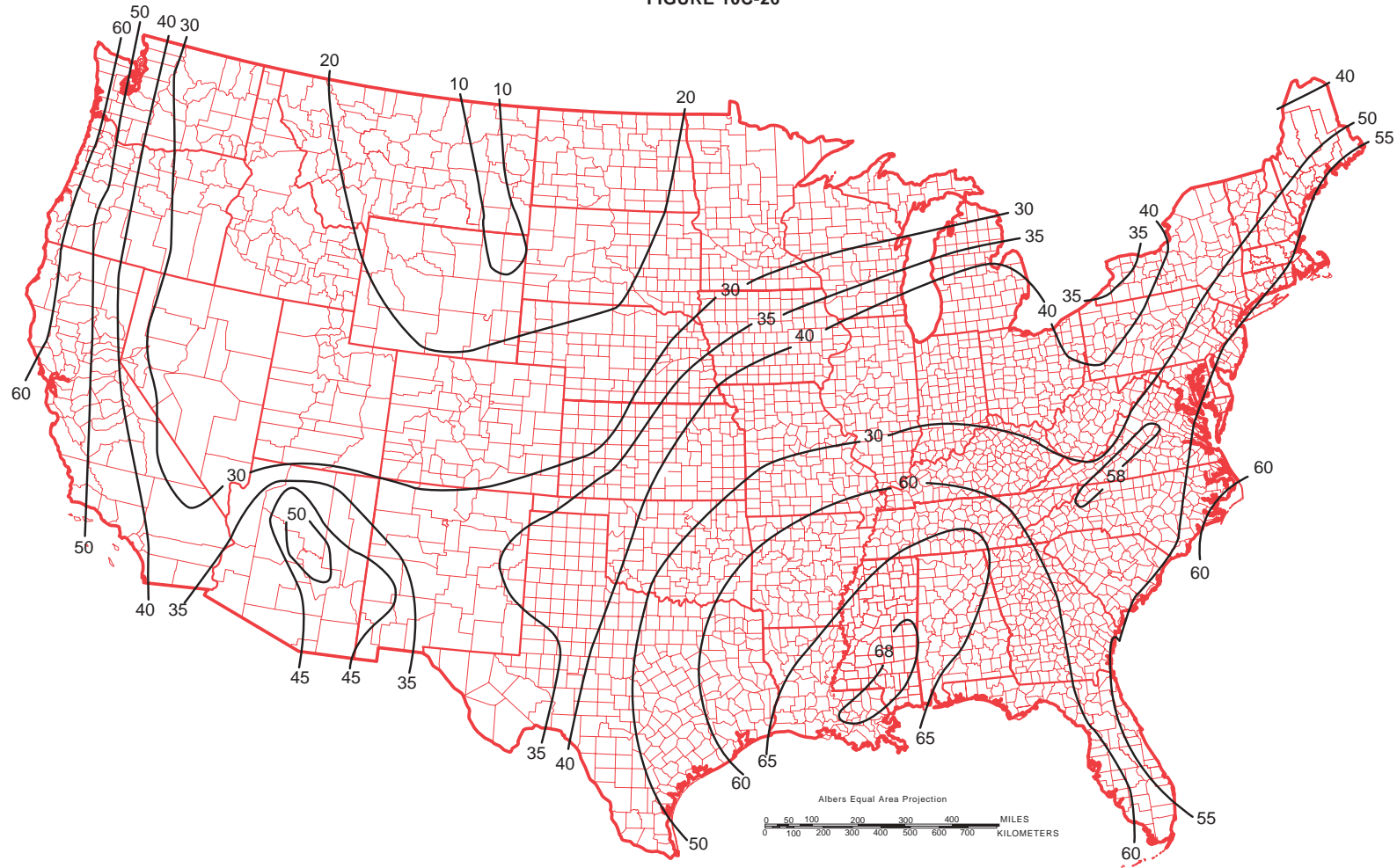
(210-VI-AWMPFH, Amend. 31, 4/92)

10C-29



# DECEMBER RUNOFF FROM CONCRETE FEEDLOTS (CN-97) AS PERCENT OF MEAN MONTHLY PRECIPITATION

FIGURE 10C-26

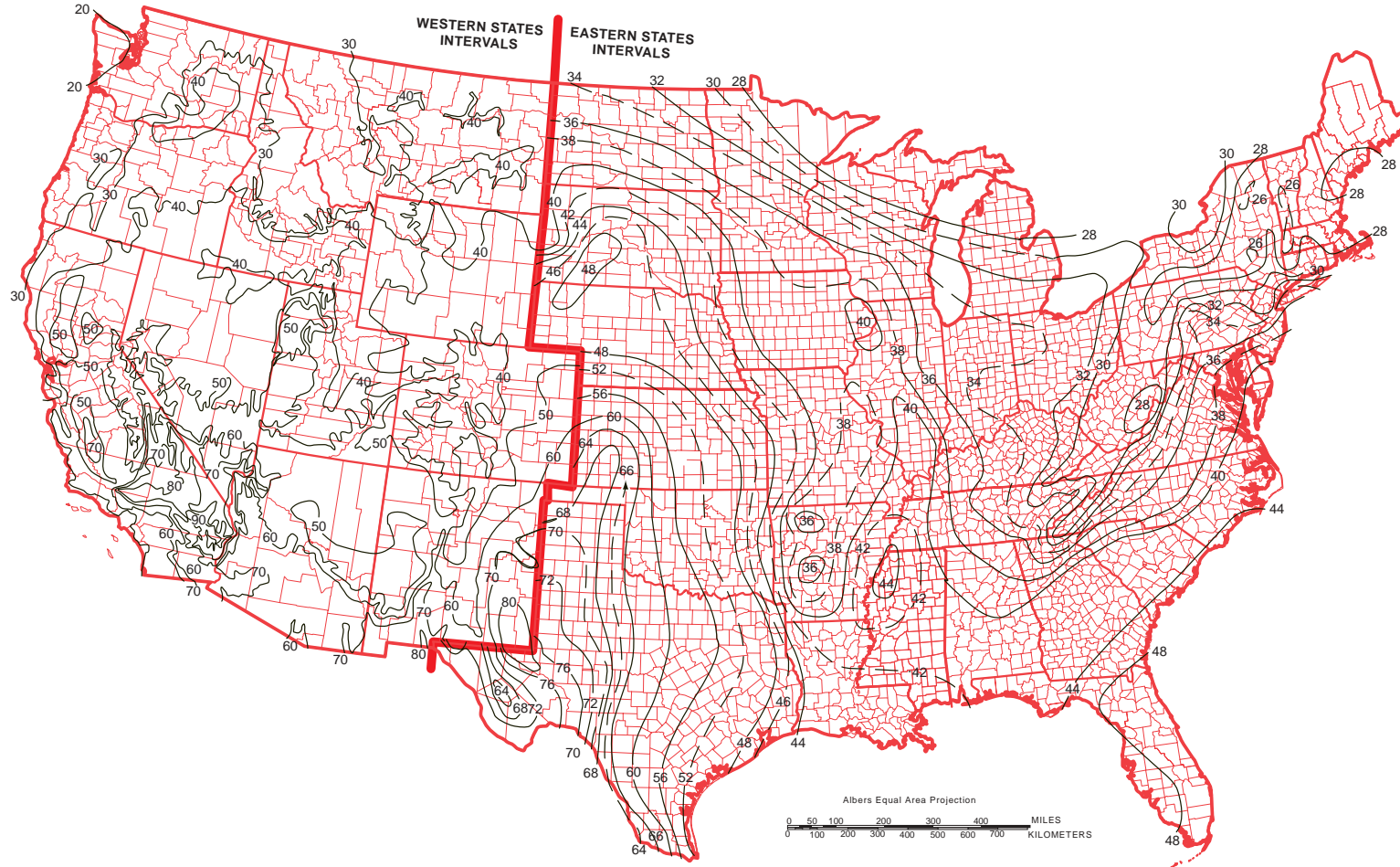


SOURCE:  
DATA PROVIDED BY SCS FIELD PERSONEL. MAP PREPARED USING  
AUTOMATED MAP CONSTRUCTION. NATIONAL CARTOGRAPHIC CENTER,  
FORT WORTH, TEXAS 1991

REVISED MARCH 1991 1004852

# ANNUAL FREE WATER SURFACE EVAPORATION

FIGURE 10C-27



(210-VI-AWMPH, Amend. 31, 4/92)

SOURCE:  
DATA PROVIDED BY SCS FIELD PERSONEL. MAP PREPARED USING  
AUTOMATED MAP CONSTRUCTION. NATIONAL CARTOGRAPHIC CENTER,  
FORT WORTH, TEXAS 1991

REVISED MARCH 1991 1004856

This page intentionally left blank.

# **Appendix 10D Design and Construction Guidelines for Waste Impoundments Lined with Clay or Amendment-treated Soil**





## Introduction

Waste storage ponds and treatment lagoons are used in agricultural waste management systems to protect surface and ground water and as a component in a system for properly utilizing wastes. Seepage from these structures has the potential to pollute surface water and underground aquifers. The principal factors determining the potential for downward and/or lateral seepage of the stored wastes are the:

- permeability of the soil and bedrock horizons near the excavated limits of a constructed waste treatment lagoon or waste storage pond
- depth of liquid in the pond that furnishes a driving hydraulic force to cause seepage
- thickness and permeability of horizons between the boundary of the lagoon bottom and sides to the aquifer or water table

In some circumstances, where permitted by local and/or State regulations, designers may consider whether seepage may be reduced from the introduction of manure solids into the reservoir. Physical, chemical, and biological processes can occur that reduce the permeability of the soil-liquid interface. Suspended solids settle out and physically clog the pores of the soil mass. Anaerobic bacteria produce by-products that accumulate at the soil-liquid interface and reinforce the seal. The soil structure can also be altered in the process of metabolizing organic material.

Chemicals in waste, such as salts, can disperse soil, which may also be beneficial in reducing seepage. Researchers have reported that, under some conditions, the seepage rates from ponds can be decreased by up to an order of magnitude (reduced 1/10th) within a year following filling of the waste storage pond or treatment lagoon with manure. Manure with higher solids content is more effective in reducing seepage than manure with fewer solids content. Research has shown that manure sealing only occurs when soils have a minimal clay content or greater. A rule of thumb supported by research is that manure sealing is not effective unless soils have at least 15 percent clay content for monogastric animal generated waste and 5 percent clay content for ruminant animal generated waste (Barrington, Jutras, and Broughton 1987a, 1987b). Manure sealing is not considered effective

on relatively clean sands and gravels, and these soils always require a liner as described in the following sections.

Animal waste storage ponds designed prior to about 1990 assumed that seepage from the pond would be minimized by the accumulation of manure solids and a biological seal at the foundation surface. Figure 10D–1 shows one of these early sites, where the soils at grade were somewhat permeable sands. Monitoring wells installed at some sites with very sandy soils showed that seepage containing constituents from the pond was still occurring even after enough time had passed that manure sealing should have occurred.

This evidence caused U.S. Department of Agriculture (USDA) Natural Resources Conservation Service (NRCS) engineers to reconsider guidance on suitable soils for siting an animal waste storage pond. In the late 1980s guidance was developed that designs should not rely solely on the seepage reduction that might occur from the accumulation of manure solids in the bottom and on the sides of the finished structure. That initial design document was entitled “South National Technical Center (SNTC) Technical Guide 716.” It suggested that if any of four site conditions were present at a proposed structure location, a clay liner or other method of reducing seepage would be used in NRCS designs. A few revisions were made, and the document was re-issued in September 1993.

---

**Figure 10D–1** Animal waste storage pond constructed before the implementation of modern design guidelines



NRCS was reorganized in 1994, and guidance in old SNTC documents was not part of the revised document system of the Agency. Consequently, the 716 document was revised considerably, and the revised material was incorporated into appendix 10D of the Agricultural Waste Field Management Handbook (AWMFH) in October 1998. This 2008 version of appendix 10D continues to update and clarify the process of designing an animal waste storage pond that will meet NRCS-specified engineering design criteria and stated specified permeability requirements.

## General design considerations

Limiting seepage from an agricultural waste storage pond has two primary goals. The first is to prevent any virus or bacteria from migrating out of the storage facility to an aquifer or water source. The second is to prevent the conversion of ammonia to nitrate in the vadose zone. Nitrates are very mobile once they are formed by the nitrification process. They can then accumulate significantly in ground water. The National drinking water standard for nitrate is 10 parts per million, and excessive seepage from animal waste storage ponds could increase the level of nitrates in ground water above this threshold. Other constituents in the liquid manure stored in ponds may also be potential contaminants if the seepage from the pond is unacceptably high.

Defining an acceptable seepage rate is not a simple task. Appendix 10D recommends an allowable seepage quantity that is based on a historically accepted tenet of clay liner design, which is that a coefficient of permeability of  $1 \times 10^{-7}$  centimeters per second is reasonable and prudent for clay liners. This value, rightly or wrongly, has a long history of acceptability in design of impoundments of various types, including sanitary landfills.

Assuming that a typical NRCS waste impoundment has a maximum liquid depth of 9 feet, a compacted clay liner thickness of 1 foot, and a one order of magnitude reduction in seepage due to manure sealing effects, the resulting seepage associated with this historically accepted permeability rate is about  $1 \times 10^{-6}$  centimeters per second, or about 9,240 gallons per acre per day. However, the NRCS no longer recommends basing design decisions on the assumption that a full one order

of magnitude reduction will be achieved. The following criteria should be used in assessing the adequacy of a compacted clay liner system:

- When credit for a reduction of seepage from manure sealing (described later in the document) is allowed, NRCS guidance considers an acceptable initial seepage rate to be 5,000 gallons per acre per day. This higher value used for design assumes that manure sealing will result in at least a half order of magnitude reduction in the initial seepage. If State or local regulations are more restrictive, those requirements should be followed.
- If State or local regulations prohibit designs from taking credit for future reductions in seepage from manure sealing, then NRCS recommends the initial design for the site be based on a seepage rate of 1,000 gallons per acre per day. Applying an additional safety factor to this value is not recommended because it conservatively ignores the potential benefits of manure sealing.

One problem with basing designs on a unit seepage value is that the approach considers only unit area seepage. The same criterion applies for small and large facilities. More involved three-dimensional type analyses would be required to evaluate the potential impact of seepage on ground water regimes on a whole-site basis. In addition to unit seepage, studies for large storage facilities should consider regional ground water flow, depth to the aquifer likely to be affected, and other factors.

The procedures in appendix 10D to the AWMFH provide a rational approach to selecting an optimal combination of liner thickness and permeability to achieve a relatively economical, but effective, liner design. It recognizes that manipulating the permeability of the soil liner is usually the most cost-effective approach to reduce seepage quantity. While clay liners obviously allow some seepage, the limited seepage from a properly designed site should have minimal impact on ground water quality. Numerous studies, such as those done by Kansas State University (2000), have shown that waste storage ponds located in low permeability soils of sufficient thickness have a limited impact on the quality of ground water.

If regulations or other considerations require that unit seepage be less than 500 gallons per acre per day (1/56 inch per day), synthetic liners such as high-density polyethylene (HDPE), linear low-density polyethylene (LLDPE), ethylene propylene diene monomer (EPDM), or geosynthetic clay liners (GCL), concrete liners, or aboveground storage tanks may be more feasible and economical and should be considered. Figure 10D-2 shows a pond lined with a synthetic liner, figure 10D-3

shows a concrete-lined excavated pond, and figure 10D-4 shows an aboveground concrete tank. Aboveground tanks may be also constructed of fiberglass-lined steel. NRCS has significant expertise in the selection, specification, and construction of sites using these products in addition to clay liners. Guidance on these other technologies is contained in other chapters of the AWMFH.

**Figure 10D-2** Pond with synthetic liner (*Photo credit NRCS*)



**Figure 10D-4** Aboveground storage tank for animal waste (*Photo credit Mitch Cummings, Oregon NRCS*)



**Figure 10D-3** Excavated animal waste storage pond with concrete liner (*Photo credit NRCS*)



## Progressive design

Waste storage ponds and waste treatment lagoons are usually designed with specific objectives that include cost, allowable seepage, aesthetics, and other considerations. Designs are usually evaluated in a progressive manner, with less costly and simple methods considered first, and more costly and complex methods considered next. These design concepts should generally be considered in the order listed to provide the most economical, yet effective, design of these structures. The following descriptions cover details on design and installation of these individual design measures.

- The least expensive and least complex design is to locate a waste impoundment in soils that have a naturally low permeability and where horizons are thick enough to reduce seepage to acceptable levels. The site should also be located where the distance to the water table conforms to requirements of any applicable regulations.
- Soils underlying the excavated boundaries of the pond may not be thick enough or slowly permeable enough to limit seepage to acceptably low values. In this case, the next type of design often considered is a liner constructed of compacted clay or other soils with appropriate amendments. This type of liner may be constructed with soils from the excavation itself or soil may be imported from nearby borrow sources. If the soils require amendments such as bentonite or soil dispersants, the unit cost of the compacted liner will be significantly higher than for a liner that only requires compaction to achieve a satisfactorily low permeability.
- A synthetic liner may be used to line the impoundment to reduce seepage to acceptable levels. Various types of synthetic materials are available.
- A liner may be constructed of concrete, or a concrete or fiberglass-lined steel tank can be constructed above ground to store the wastes.

A useful tool in comparing design alternatives is to evaluate unit costs. Benefits of alternatives may then be compared against unit costs to aid in selecting a design alternative. Benefits may include reduced

seepage, aesthetics, or other considerations. Many geomembrane suppliers may be able to provide rough cost estimates based on the size and locale of the site. In estimating the cost of a compacted clay liner, one should evaluate the volume of compacted fill involved in a liner of given thickness. Table 10D–1 illustrates a cost comparison for different thicknesses of compacted clay liners. If methods other than compacted clay liners are used, higher unit costs may apply (table 10D–2).

**Table 10D–1** Cost comparisons of design options for compacted clay liner

Thickness of compacted liner (ft)	Number of cubic yards of fill per square foot (yd <sup>3</sup> )	Assumed cost of compacted fill, per cubic yard (\$)	Unit cost of stated thickness liner (\$/ft <sup>2</sup> )
1.0	0.037037	3.00–5.00	0.11–0.19
1.5	0.055555	3.00–5.00	0.17–0.28
2.0	0.074074	3.00–5.00	0.22–0.37
3.0	0.111111	3.00–5.00	0.33–0.56

**Table 10D–2** Cost comparison for other design options

Liner type	Unit costs (\$/ft <sup>2</sup> )
Geosynthetic	0.50–1.25
Concrete, reinforced 5 inches thick	7.50–8.00

## Soil properties

The permeability of soils at the boundary of a waste storage pond depends on several factors. The most important factors are those used in soil classification systems such as the Unified Soil Classification System (USCS). The USCS groups soils into similar engineering behavioral groups. The two most important factors that determine a soil's permeability are:

- The percentage of the sample which is finer than the No. 200 sieve size, 0.075 millimeters. The USCS has the following important categories of percentage fines:
  - Soils with less than 5 percent fines are the most permeable soils.
  - Soils with between 5 and 12 percent fines are next in permeability.
  - Soils with more than 12 percent fines but less than 50 percent fines are next in order of permeability.
  - Soils with 50 percent or more fines are the least permeable.
- The plasticity index (PI) of soils is another parameter that strongly correlates with permeability.

When considered together with percent fines, a grouping of soils into four categories of permeability is possible. The following grouping of soils is based on the experience of NRCS engineers. It may be used to classify soils at grade as an initial screening tool. Estimating permeability is difficult because so many factors determine the value for a soil. For *in situ* soils, the following factors, in addition to percent fines and PI, affect the permeability of the natural soils:

- The dry density of the natural soil affects the permeability. Soils with lower dry densities have higher percentage of voids (porosity) than more dense soils.
- Structure strongly affects permeability. Many clay soils, particularly those with PI values above 20, develop a blocky structure from desiccation. The blocky structure creates preferential flow paths that can cause soils to have an unexpectedly high permeability. Albrecht and Benson (2001) and Daniel and Wu (1993)

describe the effect of desiccation on the permeability of compacted clay liners.

- While not considered in the USCS, the chemical composition of soils with clay content strongly affects permeability. Soils with a preponderance of calcium or magnesium ions on the clay particles often have a flocculated structure that causes the soils to be more permeable than expected based simply on percent fines and PI. Soils with a preponderance of sodium or potassium ions on the clay particles often have a dispersive structure that causes the soils to be less permeable than soils with similar values of percent fines and PI. The NRCS publication TR-28, Clay Minerals, describes this as follows:

*In clay materials, permeability is also influenced to a large extent by the exchangeable ions present. If, for example, the Ca (calcium) ions in a montmorillonite are replaced by Na (sodium) ions, the permeability becomes many times less than its original value. The replacement with sodium ions reduces the permeability in several ways. For one thing, the sodium causes dispersion (disaggregation) reducing the effective particle size of the clay minerals. Another condition reducing permeability is the greater thickness of water adsorbed on the sodium-saturated montmorillonite surfaces which diminishes the effective pore diameter and retards the movement of fluid water.*

- Alluvial soils may have thin laminations of silt or sand that cause them to have a much higher horizontal permeability than vertical permeability. This property is termed anisotropy and should be considered in flow net analyses of seepage.
- Other types of deposits may have structure resulting from their mode of deposition. Loess soils often have a high vertical permeability resulting from their structure. Glacial tills may contain fissures and cracks that cause them to have a permeability higher than might be expected based only on their density, percent fines and PI of the fines.

The grouping of soils in table 10D–3 is based on the percent passing the No. 200 sieve and PI of the soils. Table 10D–4 is useful to correlate the USCS groups to one of the four permeability groups.

**Table 10D–3** Grouping of soils according to their estimated permeability. Group I soils are the most permeable, and soils in groups III and IV are the least permeable soils

Group	Description
I	Soils that have less than 20 percent passing a No. 200 sieve and have a PI less than 5
II	Soils that have 20 percent or more passing a No. 200 sieve and have PI less than or equal to 15. Also included in this group are soils with less than 20 percent passing the No. 200 sieve with fines having a PI of 5 or greater
III	Soils that have 20 percent or more passing a No. 200 sieve and have a PI of 16 to 30
IV	Soils that have 20 percent or more passing a No. 200 sieve and have a PI of more than 30

**Table 10D–4** Unified classification versus soil permeability groups <sup>1/</sup>

Unified Soil Classification System Group Name	Soil permeability group number and occurrence of USCS group in that soil			
	I	II	III	IV
CH	N	N	S	U
MH	N	S	U	S
CL	N	S	U	S
ML	N	U	S	N
CL–ML	N	A	N	N
GC	N	S	U	S
GM	S	U	S	S
GW	A	N	N	N
SM	S	U	S	S
SC	N	S	U	S
SW	A	N	N	N
SP	A	N	N	N
GP	A	N	N	N

1/ ASTM Method D–2488 has criteria for use of index test data to classify soils by the USCS.

A = Always in this permeability group

N = Never in this permeability group

S = Sometimes in this permeability group (less than 10 percent of samples fall in this group)

U = Usually in this permeability group (more than 90 percent of samples fall in this group)

## Permeability of soils

Table 10D–5 shows an approximate range of estimated permeability values for each group of soils in table 10D–3. The ranges are wide because the classification system does not consider other factors that affect the permeability of soils, such as the electrochemical nature of the clay in the soils. Two soils may have similar percent finer than the No. 200 sieves and PI values but have very different permeability because of their different electrochemical makeup. The difference can easily be two orders of magnitude (a factor of 100). The most dramatic differences are between clays that have a predominance of sodium compared to those with a preponderance of calcium or magnesium. High calcium soils are more permeable than high sodium soils.

Table 10D–5 summarizes the experienced judgment of NRCS engineers and generally used empirical correlations of other engineers. The correlations are for *in situ* soils at medium density and without significant structure or chemical content. Information shown in figure 10D–5 is also valuable in gaining insight into the probable permeability characteristics of various soil and rock types.

Some soils in groups III and IV may have a higher permeability than indicated in table 10D–5 because they contain a high amount of calcium. High amounts of calcium result in a flocculated or aggregated structure in soils. These soils often result from the weathering

**Table 10D–5** Grouping of soils according to their estimated permeability. Group I soils are the most permeable and soils in groups III and IV are the least permeable soils.

Group	Percent fines	PI	Estimated range of permeability, cm/s	
			Low	High
I	< 20	< 5	$3 \times 10^{-3}$	2
II	$\geq 20$	$\leq 15$	$5 \times 10^{-6}$	$5 \times 10^{-4}$
	< 20	$\geq 5$		
III	$\geq 20$	$16 \leq \text{PI} \leq 30$	$5 \times 10^{-8}$	$1 \times 10^{-6}$
IV	$\geq 20$	> 30	$1 \times 10^{-9}$	$1 \times 10^{-7}$

of high calcium parent rock, such as limestone. Soil scientists and published soil surveys are helpful in identifying these soil types.

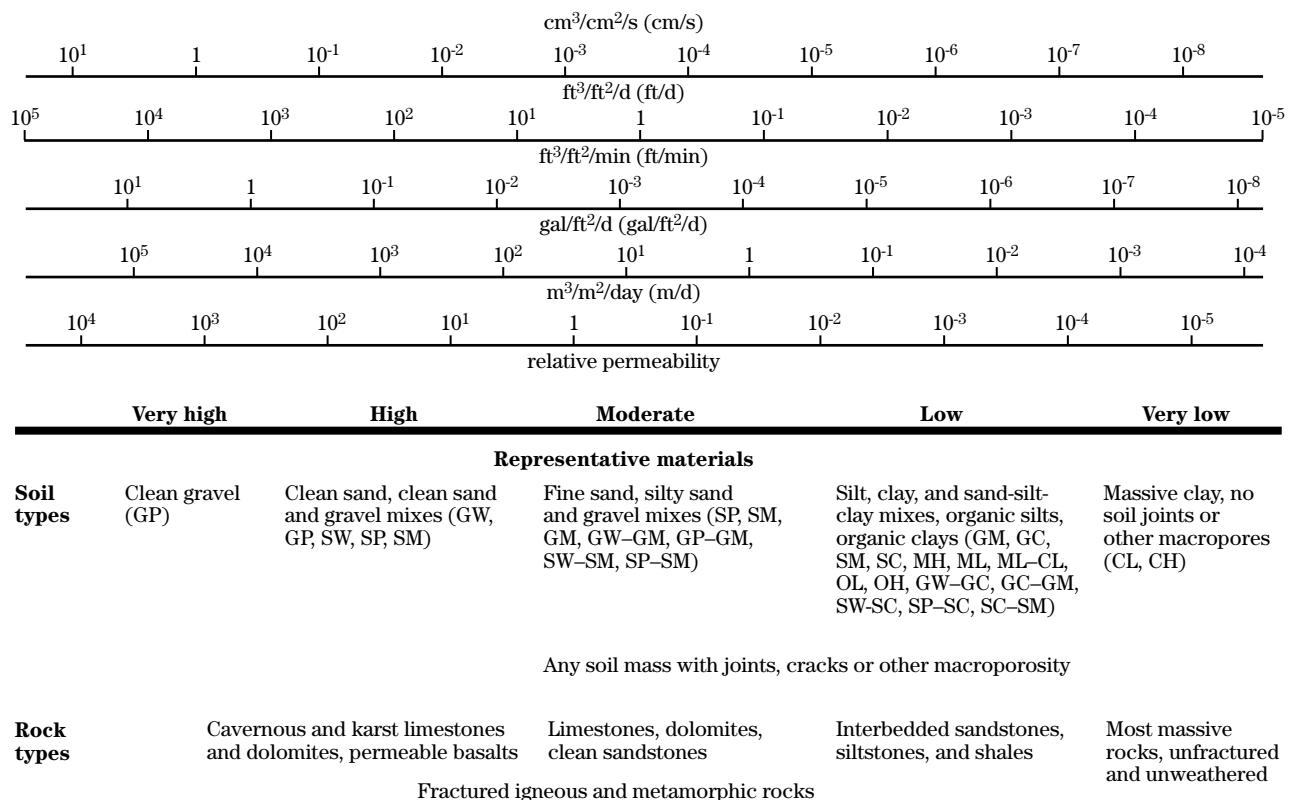
High calcium clays should usually be modified with soil dispersants to achieve the target permeability goals. Dispersants, such as tetrasodium polyphosphate, can alter the flocculated structure of these soils by replacement of the calcium with sodium. Because manure contains salts, it can aid in dispersing the structure of these soils, but design should not rely on manure as the only additive for these soil types.

Soils in group IV usually have a very low permeability. However, because of their sometimes blocky structure, caused by desiccation, high seepage losses can

occur through cracks that can develop when the soil is allowed to dry. These soils possess good attenuation properties if the seepage does not move through cracks in the soil mass. Soils with extensive desiccation cracks should be disked, watered, and recompact to destroy the structure in the soils to provide an acceptable permeability. The depth of the treatment required should be based on design guidance given in the section **Construction considerations for compacted clay liners.**

High plasticity soils like those in group IV should be protected from desiccation in the interim period between construction and filling the pond. Ponds with intermittent storage should also consider protection for high PI liners in their design.

**Figure 10D-5** Permeability of various geologic material (from Freeze and Cherry 1979)





## ***In situ* soils with acceptable permeability**

For screening purposes, NRCS engineers have determined that if the boundaries of a planned pond are underlain on the sides and bottom both by a minimum thickness of natural soil in permeability groups III or IV, the seepage from those ponds is generally low enough to cause no degradation of ground water. This assumes that soils do not have a flocculated structure. Unless State regulations or other requirements dictate a more conservative method of limiting seepage, it is the position of NRCS that special design measures generally are not necessary where agricultural waste storage ponds or treatment lagoons are constructed in these soils, provided that:

- at least 2 feet of natural soil in groups III or IV occur below the bottom and sides of the lagoon
- the soils are not flocculated (high calcium)
- no highly unfavorable geologic conditions, such as karst formations, occur at the site
- the planned depth of storage is less than 15 feet

Ponds with more than 15 feet of liquid should be evaluated by more precise methods. If the permeability and thickness of horizons beneath a structure are known, the predicted seepage quantities may be estimated more precisely. In some cases, even though a site is underlain by 2 feet of naturally low permeability soil, an acceptably low seepage rate satisfactory for some State requirements cannot be documented. In those cases, more precise testing and analyses are suggested. The accumulation of manure can provide a further decrease in the seepage rate of ponds by up to 1 order of magnitude as noted previously. If regulations permit considering this reduction, a lower predicted seepage can be assumed by designers.

## **Definition of pond liner**

**Compacted clay liner**—Compacted clay liners are relatively impervious layers of compacted soil used to reduce seepage losses to an acceptable level. A liner for a waste impoundment can be constructed in several ways. When soil alone is used as a liner, it is often called a clay blanket or impervious blanket. A

simple method of providing a liner for a waste storage structure is to improve a layer of the soils at the excavated grade by disking, watering, and compacting the soil to a thickness indicated by guidelines in following sections. Compaction is often the most economical method for constructing liners if suitable soils are available nearby or if soils excavated during construction of the pond can be reused to make a compacted liner. Soils with suitable properties can make excellent liners, but the liners must be designed and installed correctly. Soil has an added benefit in that it provides an attenuation medium for many types of pollutants. NRCS Conservation Practice Standard (CPS) 521D, Pond Sealing or Lining Compacted Clay Treatment, addresses general design guidance for compacted clay liners for ponds.

If the available soils cannot be compacted to a density and water content that will produce an acceptably low permeability, several options are available, and described in the following section. The options involve soil additives to improve the permeability of the soils and adding liners constructed of materials other than natural soils.

**Treat the soil at grade with bentonite or a soil dispersant**—Designers must be aware of which amendment is appropriate for adding to specific soils at a site. In the past, bentonite has been inappropriately used to treat clay soils and soil dispersants have inappropriately been used to treat sands with a small clay content.

The following guidelines are helpful and should be closely followed.

- **When to use bentonite**—Soils in groups I and II have unacceptably high permeability because they contain an insufficient quantity of clay or the clay in the soils is less active than required. A useful rule of thumb is that soils amenable for treatment with bentonite will have PI values less than 7, or they will have less than 30 percent finer than the No. 200 sieve, or both.

Bentonite is essentially a highly concentrated clay product that can be added in small quantities to a sand or slightly plastic silt to make it relatively low in permeability. CPS 521C, Pond Sealing or Lining Bentonite Treatment, covers this practice. NRCS soil mechanics laboratories have found it important to use the same type

and quality of bentonite planned for construction in the laboratory permeability tests used to design the soil-bentonite mixture. Both the quality of the bentonite and how finely ground the product is before mixing with the soil will strongly affect the final permeability rate of the mixture. It is important to work closely with both the bentonite supplier and the soil testing facility when designing treated soil liners.

- **When to use soil dispersants**—Soils in groups III and IV may have unacceptably high permeability because they contain a preponderance of calcium or magnesium on the clay particles. Unfortunately, field or lab tests to determine when soils are likely to have this problem are not available. High calcium soils often occur when parent materials have excessive calcium. Many soils developed from weathering of limestone and gypsum may have this problem. See the section Design and construction of clay liners treated with soil dispersants, for more detail. Some States require the routine use of soil dispersants in areas that are known to have high calcium clay soils.

**Use of concrete or synthetic materials such as geomembranes and geosynthetic clay liners (GCLs)**—Concrete has advantages and disadvantages for use as a liner. A disadvantage is that it will not flex to conform to settlement or shifting of the earth. In addition, some concrete aggregates may be susceptible to attack by continued exposure to chemicals contained in or generated by the waste. An advantage is

that concrete serves as an excellent floor from which to scrape solids. It also provides a solid support for equipment such as tractors or loaders.

Geomembranes and GCLs are the most impervious types of liners if designed and installed correctly. Care must be exercised both during construction and operation of the waste impoundment to prevent punctures and tears. The most common defects in these liners arise from problems during construction. Forming seams in the field for geomembranes can require special expertise. GCLs have the advantage of not requiring field seaming, but overlap is required to provide a seal at the seams. Geomembranes must contain ultraviolet inhibitors if exposed to sunlight. Designs should include provision for protection from damage during cleaning operations. Concrete pads, double liners, and soil covering are examples of protective measures. Figure 10D–6 shows an agricultural waste storage facility with a geomembrane liner with ultraviolet inhibitors.

## When a liner should be considered

A constructed liner may be required if any of the conditions listed are present at a planned impoundment.

**Proposed impoundment is located where any underlying aquifer is at a shallow depth and not confined and/or the underlying aquifer is a domestic or ecologically vital water supply**—State or local regulations may prevent locating a waste storage impoundment within a specified distance from such features. Even if the pond bottom and sides are underlain by 2 feet of naturally low permeability soil, if the depth of liquid in the pond is high enough, computed seepage losses may be greater than acceptable. The highest level of investigation and design is required on sites like those described. This will ensure that seepage will not degrade aquifers at shallow depth or aquifers that are of vital importance as domestic water sources.

**Excavation boundary of an impoundment is underlain by less than 2 feet of suitably low permeability soil, or an equivalent thickness of soil with commensurate permeability, over bedrock**—Bedrock that is near the soil surface is often fractured or jointed because of weathering and stress relief.

**Figure 10D–6** Agricultural waste storage impoundment lined with a geomembrane (*Photo credit NRCS*)



Many rural domestic and stock water wells are developed in fractured rock at a depth of less than 300 feet. Some rock types, such as limestone and gypsum, may have wide, open solution channels caused by chemical action of the ground water. Soil liners may not be adequate to protect against excessive leakage in these bedrock types. Concrete or geomembrane liners may be appropriate for these sites. However, even hairline openings in rock can provide avenues for seepage to move downward and contaminate subsurface water supplies. Thus, a site that is shallow to bedrock can pose a potential problem and merits the consideration of a liner. Bedrock at a shallow depth may not pose a hazard if it has a very low permeability and has no unfavorable structural features. An example is massive siltstone.

**Excavation boundary of an impoundment is underlain by soils in group I**—Coarse grained soils with less than 20 percent low plasticity fines generally have higher permeability and have the potential to allow rapid movement of polluted water. The soils are also deficient in adsorptive properties because of their lack of clay. Relying solely on the sealing resulting from manure solids when group I soils are encountered is not advisable. While the reduction in permeability from manure sealing may be one order of magnitude, the final resultant seepage losses are still likely to be excessive, and a liner should be used if the boundaries of the excavated pond are in this soil group.

**Excavation boundary of an impoundment is underlain by some soils in group II or problem soils in group III (flocculated clays) and group IV (highly plastic clays that have a blocky structure)**—Soils in group II may or may not require a liner. Documentation through laboratory or field permeability testing and computations of specific discharge (unit seepage quantities) is advised. Higher than normal permeability can occur when soils in group III or IV are flocculated or have a blocky structure. These are special cases, and most soils in groups III and IV will not need a liner provided the natural formation is thick enough to result in acceptable predicted seepage quantities.

These conditions do not always dictate a need for a liner. Specific site conditions can reduce the potential risks otherwise indicated by the presence of one of these conditions. For example, a thin layer of soil over

high quality rock, such as an intact shale, is less risky than if the thin layer occurs over fractured or fissured rock. If the site is underlain by many feet of intermediate permeability soil, that site could have equivalent seepage losses as one underlain by only 2 feet of low permeability soil.

Some bedrock may contain large openings caused by solutioning and dissolving of the bedrock by ground water. Common types of solutionized bedrock are limestone and gypsum. When sinks or openings are known or identified during the site investigation, these areas should be avoided and the proposed facility located elsewhere. However, when these conditions are discovered during construction or alternate sites are not available, concrete or geosynthetic liners may be required, but only after the openings have been properly cleaned out and backfilled with concrete.

## Specific discharge

### Introduction

One way to require a minimal design at a site is to require a minimum thickness of a given permeability soil for a natural or constructed liner. An example of this would be to require that a clay liner constructed at a waste storage pond should be at least 1 foot thick, and the soil should have a coefficient of permeability of  $1 \times 10^{-7}$  centimeters per second or less.

However, using only permeability and thickness of a boundary horizon as a criterion ignores the effect of the depth of liquid on the predicted quantity of seepage from an impoundment. Using this approach would mean that the same design would be used for a site with 30 feet of water as one with 8 feet of water, for instance. A more rational method for stating a limiting design requirement is to compute seepage using Darcy's law for a unit area of the pond bottom.

A rational method of comparing design alternatives at a given site is needed. Such a method allows designers to evaluate the effect of changing one or more of the design elements in a site on the predicted seepage quantities. This document presents methods for computing the term "specific discharge" to use in comparing alternatives and to document a given design goal for a site. Specific discharge is defined as unit seepage.

It does not reflect the total seepage from a site, but rather provides a value of seepage per square unit area of pond bottom.

This document uses calculations of specific discharge to compare design alternatives and to determine if a given design meets regulatory requirements and guidelines. In some cases, the total seepage from a pond may be of interest, particularly for larger ponds in highly environmentally sensitive environments.

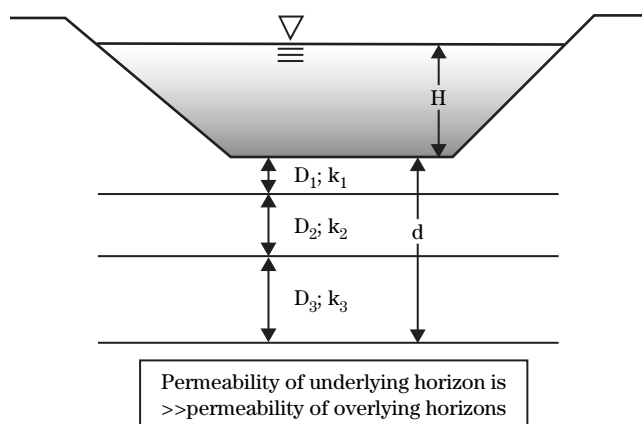
In those cases, more elaborate three-dimensional seepage computations using sophisticated finite-element computer programs may be warranted. It is outside the scope of this document to describe these types of analyses. Specialists who are experienced in using the complex software used for these computations should be consulted.

The parameters that affect the seepage from a pond with a natural or constructed clay liner are:

- The size of the pond—The total bottom area and area of the exposed sides of the pond holding the stored waste solids and liquids.

- The thickness of low permeability soil at the excavation limits of the pond—For design, the thickness of the soil at the bottom of the pond is often used because that is where seepage is likely to be highest. In some cases, however, seepage from the sides of the pond may also be an important factor. Seepage from the sides of ponds is best analyzed using finite element flow net programs. In some cases, rather than a single horizon, multiple horizons may be present.
- The depth of liquid in the pond—The depth of liquid at the top of the reservoir when pumping should commence is normally used.
- The coefficient of permeability of the soil forming the bottom and sides of the pond—In layered systems, an average or weighted permeability may be determined as shown in figure 10D-7.

**Figure 10D-7** Conversion of permeability in layered profile to single value



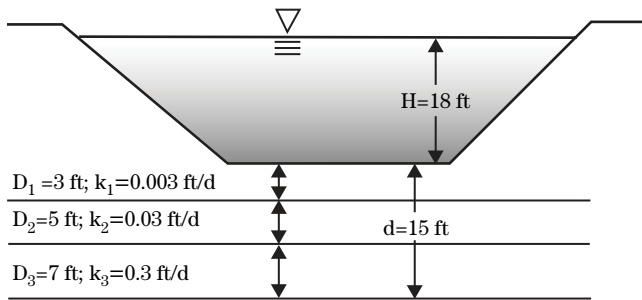
$$k_{\text{average}} = \frac{d}{\frac{D_1}{k_1} + \frac{D_2}{k_2} + \frac{D_3}{k_3}}$$

Example 10D-1 shows how to convert a multiple layer system into a single equivalent permeability. Using this method allows a designer to compute specific discharge when several horizons of constructed or natural soils occur below a site.

**Example 10D-1**

The excavated pond is underlain by 15 feet of soil consisting of three different horizons (fig. 10D-8). The thickness and permeability of each horizon is shown in the sketch. Compute the average vertical permeability of the 15 feet of soil.

**Figure 10D-8** Idealized soil profile for example 10D-1



**Solution**

$$k_{\text{average}} = \frac{d}{\frac{D_1}{k_1} + \frac{D_2}{k_2} + \frac{D_3}{k_3}}$$

$$k_{\text{average}} = \frac{15}{\frac{3}{0.003} + \frac{5}{0.03} + \frac{7}{0.3}} = 0.0126 \text{ ft/d}$$

**Definition of specific discharge**

The term “specific discharge” has been coined to denote the unit seepage that will occur through the bottom of a pond with a finite layer of impervious soil. Specific discharge is the seepage rate for a unit cross-sectional area of a pond. It is derived from Darcy’s law as follows. First, consider Darcy’s law.

$$Q = k \times i \times A$$

For a pond with either a natural or constructed liner, the hydraulic gradient is the term *i* in the equation, and it is defined in figure 10D-9 as equal to (H+d)/d.

Given:

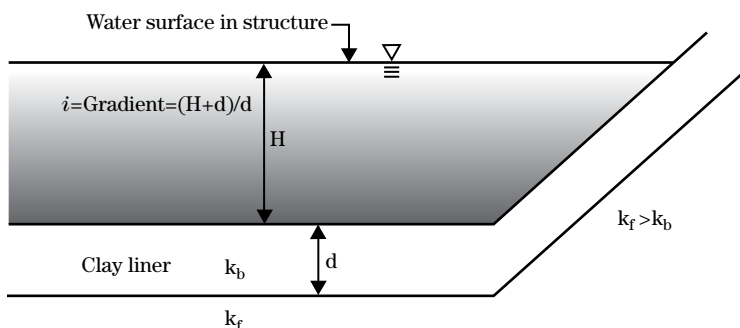
The Darcy’s law for this situation becomes:

$$Q = k \times \frac{H+d}{d} \times A$$

where:

- Q = total seepage through area A (L<sup>3</sup>/T)
- k = coefficient of permeability (hydraulic conductivity) (L<sup>3</sup>/L<sup>2</sup>/T)
- i = hydraulic gradient (L/L)
- H = vertical distance measured between the top of the liner and top of the liquid storage of the waste impoundment (fig. 10D-9) (L)
- d = thickness of the soil liner (fig. 10D-9) (L)
- A = cross-sectional area perpendicular to flow (L<sup>2</sup>)
- L = length
- T = time

**Figure 10D-9** Definition of terms for clay liner and seepage calculations



Rearrange terms:

$$\frac{Q}{A} = \frac{k(H+d)}{d} \quad (L/T)$$

By definition, unit seepage or specific discharge, is  $Q \div A$ . The symbol  $v$  is used for specific discharge:

$$v = \frac{k(H+d)}{d} \quad (L^3/L^2/T)$$

Specific discharge may be confused with permeability because the units are the same. In the metric system, specific discharge and permeability are often expressed in units of centimeters per second. The actual units are cubic centimeters of flow per square centimeter of cross section per second, but this reduces to centimeters per second. Specific discharge is different than permeability because specific discharge is an actual flow rate of liquid through a cross section of a soil mass, whereas permeability is a property of the soil mass itself. Permeability is independent of the hydraulic gradient in a particular site, whereas specific discharge accounts for both permeability of the soil and the gradient causing the flow, as illustrated in figure 10D-9. Because hydraulic gradient is dimensionless, the units of specific discharge and permeability are then the same.

Because specific discharge expressed as  $L/T$  has the same units as velocity, specific discharge is often misunderstood as representing the average rate or velocity of water moving through a soil body rather than a quantity rate flowing through the soil. Because the water flows only through the soil pores, the actual cross-sectional area of flow is computed by multiplying the soil cross section ( $A$ ) by the porosity ( $n$ ). The seepage velocity is then equal to the unit seepage or specific discharge,  $v$ , divided by the porosity of the soil,  $n$ . Seepage velocity =  $(v/n)$ . In compacted liners, the porosity usually ranges from 0.3 to 0.5. The result is that the average linear velocity of seepage flow is two to three times the specific discharge value. The units of seepage velocity are  $L/T$ .

To avoid confusion between specific discharge and permeability, one possibility is to use different units for specific discharge than for the coefficient of permeability. Common units for permeability are recommended to be in feet per day or centimeters per second. Units for specific discharge should be in gallons

per acre per day, acre-feet per acre per day, or acre-inches per acre per day.

To illustrate a typical computation for specific discharge, assume the following:

- A site has a liquid depth of 12 feet.
- The site is underlain by 2 feet of soil that has a coefficient of permeability of  $1 \times 10^{-6}$  centimeters per second (assume that a sample was obtained at the grade of the pond and sent to a laboratory where a flexible wall permeability test was performed on it).
- Compute the specific discharge,  $v$ . First, the coefficient of permeability may be converted to units of feet per day by multiplying the given units of centimeters per second by 2,835.

$$k = (1 \times 10^{-6} \text{ cm/s}) \times 2,835 = 0.002835 \text{ ft/d}$$

Then, the specific discharge  $v$  is computed as follows:

$$\begin{aligned} v &= k \times \frac{H+d}{d} \\ &= 0.002835 \times \frac{12+2}{2} \\ &\cong 0.02 \text{ ft}^3/\text{ft}^2/\text{d} \\ &\cong 0.02 \text{ ft/d} \end{aligned}$$

Conversion factors for specific discharge are given in table 10D-6.

**Table 10D-6** Conversion factors for specific discharge

To convert from	To units of	Multiply by
$\text{ft}^3/\text{ft}^2/\text{d}$	$\text{in}^3/\text{in}^2/\text{d}$	12
$\text{ft}^3/\text{ft}^2/\text{d}$	gal/acre/d	325,829
$\text{in}^3/\text{in}^2/\text{d}$	gal/acre/d	27,152.4
$\text{in}^3/\text{in}^2/\text{d}$	$\text{cm}^3/\text{cm}^2/\text{s}$	$2.94 \times 10^{-5}$
$\text{cm}^3/\text{cm}^2/\text{s}$	gal/acre/d	$9.24 \times 10^8$
$\text{cm}^3/\text{cm}^2/\text{s}$	$\text{in}^3/\text{in}^2/\text{d}$	34,015
$\text{cm}^3/\text{cm}^2/\text{s}$	$\text{ft}^3/\text{ft}^2/\text{d}$	2,835

To convert the computed specific discharge in the example into units of gallons per acre per day and cubic inches per square inch per day (in/d), use conversion factors given in table 10D–6.

- 0.02 foot per day  $\times 325,829 \cong 6,500$  gallons per acre per day
- 0.02 foot per day  $\times 12 = 0.24$  cubic inch per square inch per day

A variety of guidelines have been used and regulatory requirements stated for specific discharge. Usually, guidelines require the specific discharge for a given waste storage structure to be no higher than a stated value. The following example demonstrates the unit seepage that will result from a typical size animal waste storage lagoon or storage pond with 2 feet of either very good natural soil or a very well constructed, 2-foot-thick clay liner in the bottom of the lagoon. A practical lower limit for the assumed permeability of a compacted clay or a very good natural liner is a coefficient of permeability equal to  $5 \times 10^{-8}$  centimeters per second. This is based on considerable literature on field and laboratory tests for compacted clay liners used in sanitary landfills.

The specific discharge for this ideal condition follows, assuming:

- The pond has a liquid depth of 15 feet.
- The site is underlain by 2 feet of soil (either a natural layer or a constructed clay liner) that has a coefficient of permeability of  $5 \times 10^{-8}$  centimeters per second
- Compute the specific discharge,  $v$ . First, the coefficient of permeability is converted to units of feet per day by multiplying the given units of centimeters per second by 2,835. Then,

$$k = (1 \times 10^{-6} \text{ cm/s}) \times 2,835 = 0.002835 \text{ ft/d}$$

Then, the specific discharge  $v$  is computed as follows:

$$\begin{aligned} v &= k \times \frac{H + d}{d} \\ &= 1.42 \times 10^{-4} \text{ ft/d} \times \frac{15 \text{ ft} + 2 \text{ ft}}{2 \text{ ft}} \\ &\cong 0.0012 \text{ ft}^3/\text{ft}^2/\text{d} \\ &\cong 0.0012 \text{ ft/d} \end{aligned}$$

Converting this into units of gallons per acre per day:

$$0.0012 \text{ ft/d} \times 325,829 \cong 393 \text{ gal/acre/d}$$

Table 10D–7 lists typical specific discharge values used by State regulatory agencies. Requirements vary from State to State. Individual designers may regard minimum requirements as too permissive. Some States permit a designer to assume that the initial computed seepage rate will be reduced in the future by an order of magnitude by taking credit for a reduction in permeability resulting from manure sealing. Although the State or local regulations should be used in design for a specific site, the NRCS no longer recommends assuming that manure sealing will result in one order of magnitude reduction. A more conservative assumption described previously allows an initial seepage rate of 5,000 gallons per acre per day, which for the assumed typical site dimensions of 9 feet of liquid and 1 foot thickness of liner, assumes a one half order of magnitude reduction.

## Design of compacted clay liners

If a site does not have a sufficient thickness of *in situ* low permeability soil horizons to limit seepage to an acceptably low value, a clay liner may be required. Some State regulations may also require a constructed clay liner regardless of the nature of the *in situ* soils at a site. Regulations sometimes require a specific thickness of a compacted soil with a documented permeability of a given value. An example of this is a State requirement that a waste storage pond must have in the bottom and sides of the pond at least 2 feet of compacted clay with a documented coefficient of permeability of  $1 \times 10^{-7}$  centimeters per second.

**Table 10D–7** Typical requirement for specific discharge used by State regulatory agencies

Example specific discharge value	Equivalent value in gallons per acre per day
$1/56 \text{ in}^3/\text{in}^2/\text{d}$	485
$1/8 \text{ in}^3/\text{in}^2/\text{d}$	3,394
$1/4 \text{ in}^3/\text{in}^2/\text{d}$	6,788
$1 \times 10^{-6} \text{ cm}^3/\text{cm}^2/\text{s}$	924

Clay liners may also be designed based on a stated allowable specific discharge value. Computations may be performed as detailed in following sections to determine a design that will meet a design specific discharge goal.

## Detailed design steps for clay liners

The suggested steps for design of a compacted clay or amendment-treated liner are:

*Step 1*—Size the impoundment to achieve the desired storage requirements within the available construction limits and determine this depth or the height, H, of storage needed.

*Step 2*—Determine (from a geologic investigation) the thickness and permeability of horizons of natural clay underlying the bottom of the planned excavated pond. Investigate to a minimum of 2 feet below the planned grade of the pond or to depths required by State regulations, if greater. If natural low permeability horizons at least 2 feet thick or an equivalent thickness of soil with different permeability do not underlie the site, assume that a compacted clay liner (with or without amendments) will be constructed. The liner may be constructed of soils from the excavation if they are suitable for use, or soil may be imported from a nearby borrow source.

*Step 3*—Measure or estimate the permeability of the natural horizons or the compacted liner planned at the site. Use procedures shown in example 10D-1 to obtain a weighted permeability for the natural horizons.

*Step 4*—Compute the specific discharge using the values of head in the pond and thickness of natural horizons and their equivalent permeability in the specific discharge equation. If State or local regulations provide a required value for allowable specific discharge, design on the basis of those regulations. Currently, State regulations for specific discharge range from a low of about 500 gallons per acre per day (1/56 inch per day) to a high of about 6,800 gallons per acre per day (1/4 inch per day). If no regulations exist, a value of 5,000 gallons per acre per day may be used. If a designer feels that more conservative limiting

seepage is advisable, that rate should be used in computations. It is seldom technically or economically feasible to meet a design specific discharge value of less than 500 gallons per acre per day using compacted clay liners or amendment-treated soil liners. To achieve lower values of unit seepage usually requires synthetic liners, concrete liners, or aboveground storage tanks.

*Step 5*—If the computed specific discharge meets design objectives, the site is satisfactory without additional design and may be designed and constructed.

*Step 6*—If the computed specific discharge at the site does not meet design objectives, use either method A or method B shown in following sections to design a compacted clay liner or a liner with soil amendment.

### Notes to design steps:

- The calculated thickness of the soil liner required is sensitive to the relative values of soil permeability and the assumed allowable specific discharge value.
- The best and most economical way to reduce the required liner thickness is by reducing the soil's permeability. Liner permeability may be reduced by compacting soils to a higher degree, compacting them at a higher water content, and by using an appropriate additive such as bentonite or soil dispersants.
- By using higher compaction water contents and compacting soils to a high degree of saturation, permeability often can be reduced by a factor of 1/100.
- The liner soil must be filter compatible with the natural foundation upon which it is compacted. Filter compatibility is determined by criteria in NEH 633, chapter 26. As long as the liner soil will not pipe into the foundation, the magnitude of hydraulic gradient across the liner need not be limited.
- Filter compatibility is most likely to be a significant problem when a liner is constructed directly on top of very coarse soil, such as poorly graded gravels and gravelly sands.
- The minimum recommended thickness of a compacted clay liner is given in CPS 521D. The



minimum thickness varies with the depth of liquid in the pond.

- Clay liners constructed by mixing bentonite with the natural soils at a site should have a minimum thickness shown in CPS 521C. These minimum thicknesses are based on construction considerations rather than calculated values for liner thickness requirement from the specific discharge equations. In other words, if the specific discharge equations indicate a 7-inch thickness of compacted bentonite-treated liner is needed to meet suggested seepage criteria, the CPS 521C could dictate a thicker liner. That guidance should be considered in addition to the specific discharge computations.
- Natural and constructed liners must be protected against damage by mechanical agitators or other equipment used for cleaning accumulated solids from the bottom of the structure. Liners should also be protected from the erosive forces of waste liquid flowing from pipes during filling operations. CPSs provide guidance for protection.
- Soil liners may not provide adequate confidence against ground water contamination if foundation bedrock beneath the pond contains large, connected openings. Collapse of overlying soils into the openings could occur. Structural liners of reinforced concrete or geomembranes should be considered because the potential hazard of direct contamination of ground water is significant.
- Liners should be protected against puncture from animal traffic and roots from trees and large shrubs. The subgrade must be cleared of stumps and large angular rocks before construction of the liner.
- If a clay liner (or a bentonite-treated liner) is allowed to dry, it may develop drying cracks or a blocky structure. Desiccation can occur during the initial filling of the waste impoundment and later when the impoundment is emptied for cleaning or routine pumping. Disking, adding water, and compaction are required to destroy this structure created by desiccation. A protective insulating blanket of less plastic soil may be effective in protecting underlying more plastic soil from desiccation during these times the

liner is exposed. CPSs address this important consideration.

- Federal and State regulations may be more stringent than the design guidelines given, and they must be considered in the design. Examples later in this section address consideration of alternative guidelines.

## Two methods for designing constructed clay liner

Two methods for designing a clay liner are available. In method A, designers begin with an assumed or required value for allowable specific discharge. Using the depth of liquid storage in the pond and known or estimated values of the liner's coefficient of permeability, a required thickness of liner is computed. If the value obtained is unrealistic, different values for the liner permeability are evaluated to determine what values produce a desirable thickness of liner. CPSs also determine minimum liner thicknesses.

In method B, designers begin with a desired thickness of liner and an assumed or required value for specific discharge. Using the depth of liquid storage in the pond and the desired thickness of liner, a required coefficient of permeability for the liner is computed. If the value obtained is unrealistic, different values for the liner thickness are evaluated to determine what values produce an achievable permeability. Coordinating with soil testing laboratories is helpful in evaluating alternatives that can provide the required permeability for the liner.

Each of these methods is illustrated with detailed design examples as follows:

**Method A**—Using assumed values for the coefficient of permeability of a compacted clay based on laboratory tests of the proposed liner soil, compute the required thickness of a liner to meet the given specific discharge design goal. In the absence of more restrictive State regulations, assume an acceptable specific discharge of 5,000 gallons per acre per day.

The required thickness of a compacted liner can be determined by algebraically rearranging the specific discharge equation, as follows. Terms have been previously defined.

$$d = \frac{k \times H}{v - k}$$

**Note:** If the  $k$  value assumed for the liner is equal to or greater than the assumed allowable specific discharge, meaningless results are attained for  $d$ , the calculated thickness of the liner in the last equation. The reason is that the denominator would be zero, or a negative number. Another way of stating this is that the allowable specific discharge goal cannot be met if the liner soils have  $k$  values equal to or larger than the assumed allowable specific discharge, in consistent units. Note also that CPS 521D has requirements for minimum thickness of compacted clay liners. If the computed value for the required thickness is less than that given in CPS 521D, then the values in the CPS must be used.

#### Example 10D–2—Design a clay liner using method A

##### *Given:*

Site design has a required depth of waste liquid,  $H$ , in the constructed waste impoundment of 12 feet. A soil sample was obtained and submitted to a soil mechanics laboratory for testing. A permeability test on a sample of proposed clay liner soil resulted in a permeability value of  $6.5 \times 10^{-7}$  centimeters per second (0.00184 ft/d) for soils compacted to 95 percent of maximum Standard Proctor dry density at a water content 2 percent wet of optimum. The State requirement for the site requires a specific discharge no greater than an eighth of an inch per day. Compute the required thickness of liner to be constructed of soil having the stated permeability that will achieve this specific discharge.

##### *Solution:*

First, convert the required specific discharge into the same units as will be used for the coefficient of permeability. Using values for permeability of feet per day, convert the stated eighth of an inch per day specific discharge requirement into feet per day. To convert, divide an eighth by 12 to obtain a specific discharge requirement of 0.010417 foot per day. It is given that the  $k$  value at the design density and water content is 0.00184 foot per day. Calculate the required minimum thickness of compacted liner as follows:

The equation for required  $d$  is:

$$d = \frac{k \times H}{v - k}$$

Using English system units, substituting the given values for  $H$  and  $k$ , assuming an allowable specific discharge,  $v$ , of 0.010417 foot per day, then

$$d = \frac{0.00184 \text{ ft/d} \times 12 \text{ ft}}{0.010417 \text{ ft/d} - 0.00184 \text{ ft/d}} = 2.6 \text{ ft}$$

CPS 521D requires a pond with a depth of water of 12 feet to have a minimum thickness liner of 1 foot, so the 2.6 foot requirement governs.

**Method B**—Using a given value for depth of liquid in the pond, assumed values for the thickness of a compacted clay based on construction considerations, CPS 521D requirements, State regulations, or the preference of the designer, compute the required permeability of a liner to meet the given specific discharge design goal. In the absence of more restrictive State regulations, assume an acceptable specific discharge of 5,000 gallons per acre per day. The required permeability of a compacted liner can be determined by algebraically rearranging the specific discharge equation as follows. Terms have been previously defined.

$$k = \frac{v \times d}{H + d}$$

If the computed value for the required permeability is less than  $5 \times 10^{-8}$  centimeters per second ( $1.4 \times 10^{-4}$  ft/d), NRCS engineers' experience is that lower values are not practically obtainable and a thicker liner or synthetic liners should be used to achieve design goals.

#### Example 10D–3—Design a clay liner using method B

##### *Given:*

Site design has a required depth of waste liquid,  $H$ , in the constructed waste impoundment of 19 feet. CPS 521D requires a liner that is at least 18 inches (1.5 feet) thick. The site is in a State that allows NRCS design guidance of 5,000 gallons per acre per day to be used in the design. The NRCS guidance assumes that manure sealing will reduce this seepage value further and no additional credit should be taken.

##### *Solution:*

**Step 1** First, convert the required specific discharge into the same units as will be used for the coefficient of permeability. Using values for permeability of feet per day, convert the stated 5,000

gallons per acre per day specific discharge requirement into feet per day. To convert using conversions shown in table 10D–6, divide 5,000 by 325,829 to obtain a specific discharge requirement of 0.0154 foot per day. The thickness of liner is given to be 1.5 feet. Calculate the required coefficient of permeability of the compacted liner as follows:

$$k = \frac{v \times d}{H + d}$$

Using English system units, substituting the given values for H of 19 feet and for d of 1.5 feet, assuming an allowable specific discharge, v, of 0.0154 foot per day, then:

$$\begin{aligned} k &= \frac{.0154 \text{ ft/d} \times 1.5 \text{ ft}}{19 \text{ ft} + 1.5 \text{ ft}} \\ &= 1.1 \times 10^{-3} \text{ ft/d} \end{aligned}$$

Convert to centimeters per second by dividing by 2,835.

$$\begin{aligned} k &= \frac{1.1 \times 10^{-3} \text{ ft/d}}{2,835} \\ k &= 4.0 \times 10^{-7} \text{ cm/s} \end{aligned}$$

*Step 2*—The designer should coordinate testing with a laboratory to determine what combinations of degree of compaction and placement water content will result in this value of permeability or less. Design of the 1.5-foot-thick liner may proceed with those recommendations.

## Construction considerations for compacted clay liners

### Thickness of loose lifts

The permissible loose lift thickness of clay liners depends on the type of compaction roller used. If a tamping or sheepsfoot roller is used, the roller teeth should fully penetrate through the loose lift being compacted into the previously compacted lift to achieve bonding of the lifts. A loose lift thickness of 9 inches is commonly used by NRCS specifications. If the feet on rollers cannot penetrate the entire lift during compaction, longer feet or a thinner lift should be specified.

A loose layer thickness of 6 inches may be needed for some tamping rollers that have larger pad type feet that do not penetrate as well.

### Method of construction

Several methods are available for constructing a clay liner in an animal waste impoundment. Each has its advantages and disadvantages as described in following sections. A designer should consider the experience of local contractors and the relative costs of the methods in selecting the most appropriate design for a given site. The thickness of the planned soil liner, haul distance, planned side slopes for the pond, and other factors also guide a designer's decision on the best method to use.

### Bathtub construction

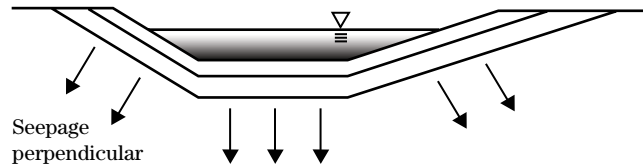
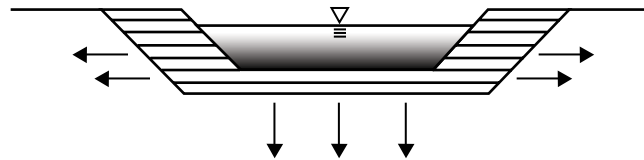
This method of construction consists of a continuous thickness of soil compacted up and down or across the slopes. Figure 10D–10 shows the orientation of the lifts of a compacted liner constructed using this method, as contrasted to the stair step method, which is covered next. Figure 10D–11 shows two sites where the bathtub method of construction is being used.

This construction method has the following advantages over the stair-step method:

- The layers of compacted clay are oriented perpendicular to flow through the liner in this method. If the lifts making up the liner are not bonded well, the effect on seepage is minor, compared to the stair-step method.
- This method lends itself to constructing thinner lifts, which is more economical.

The bathtub construction method has the following disadvantages compared to the stair-step method:

- Side slopes must be considerably flatter than for the stair-step method, creating a pond with a larger surface area. A pond with a larger surface area has to store more precipitation falling on it, which could be considered an extra cost of the method.
- To permit equipment traversing up and down the slopes, slopes must be an absolute minimum of 3H:1V. Shearing of the soil by the equipment on steeper slopes is a concern. To prevent shearing of the compacted soil, the slopes of

**Figure 10D–10** Methods of liner construction (after Boutwell 1990)**Bathtub construction****Stair-step construction****Figure 10D–11** Bathtub construction of clay liner (*photo courtesy of NRCS Virginia (top) and NRCS Nebraska (bottom)*)

many compacted liners in ponds constructed using this method use 4H:1V slopes so that equipment will exert more normal pressure on the slope than downslope pressure.

**Stair-step construction**

The stair-step method of construction is illustrated in figure 10D–10. Construction of the liner consists of compacting lifts of soil around the perimeter of the liner in a stair-step fashion, finishing the job by shaving off some of the side liner and placing it in the bottom of the pond. This method of construction is required if the side slopes of the pond are any steeper than about 3H:1V. Advantages of this method of construction are:

- A thicker blanket, measured normal to the slope, will result compared to the bathtub method of construction (fig. 10D–10). This is a positive factor in seepage reduction.
- It allows steeper side slopes, and thus the surface area of the pond exposed to rainwater accumulation is smaller than a bathtub construction would permit.
- The thicker blanket reduces the impact of shrinkage cracks, erosive forces, and potential mechanical damage to the liner.
- Ponds constructed with this method are deeper for a given volume of waste than ponds constructed with the bathtub method, which favors anaerobic processes in the pond.

Disadvantages of the method are:

- This method may be more expensive than the bathtub method because the liner on the sides of the pond are thicker.
- Flow is parallel to the orientation of the layers forming the compacted liner on the pond sides. If care is not taken to obtain good bonding between lifts, seepage through the interface between lifts could be higher than expected.
- Contractors may be less familiar with this method of operation of equipment.

In the stair-step method of construction, the pond is first excavated. Borrow soil is then imported with a truck or scraper and spread in thin lifts (8 to 9 in thick) prior to compaction. Figure 10D–12a shows the first layer being constructed on the sides of the pond. This pond used a bentonite application. Each lift of

soil is compacted with a sheepsfoot roller to obtain the desired dry density at the specified water content (fig. 10D–12b). The interior liner is constructed by bringing up lifts the full depth of the pond. Photo 10D–12c provides an overview of the stair-step process of constructing a clay liner in an animal waste storage pond. After the sides are constructed, some of the liner is shaved off and used to construct a liner in the bottom of the pond (fig. 10D–12c).

### Soil type

Soils in groups III and IV are the most desirable for constructing a clay liner (table 10D–3). Some soils in group II may also be good materials for a clay liner, but definitely require laboratory testing to document their permeability characteristics. Soils in group I always require bentonite to form a liner with acceptably low permeability. Some soils in group II may also require bentonite to be an acceptable material for a liner. Some soils in groups III and IV require a soil dispersant to create an acceptably low permeability.

### Classification

The most ideal soils for compacted liners are those in group III. The soils have adequate plasticity to provide a low permeability, but the permeability is not excessively high to cause poor workability. Group IV soils can be useful for a clay liner, but their higher plasticity index (PI greater than 30) means they are more susceptible to desiccation. If clay liners are exposed to hot dry periods before the pond can be filled, desiccation and cracking of the liner can result in an increase in permeability of the liner. A protective layer of lower PI soils is often specified for protection of higher PI clay liners to prevent this problem from developing.

Highly plastic clays like those in group IV are also difficult to compact properly. Special effort should be directed to processing the fill and degrading any clods in high plasticity clays to prevent this problem.

### Size of clods

The size and dry strength of clay clods in soil prior to compaction have a significant effect on the final quality of a clay liner. Soil containing hard clayey clods is difficult to break down and moisten thoroughly. Adding water to the soil is difficult because water penetrates the clods slowly. High speed rotary pulverizers are sometimes needed if conditions are especially unfavorable. If soils containing large clay clods are

**Figure 10D–12** Stair-step method (Photo credit John Zaginaylo, PA, NRCS)

(a)



(b)



(c)

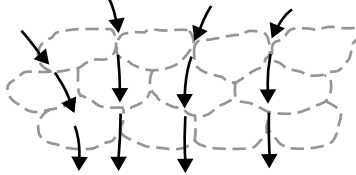




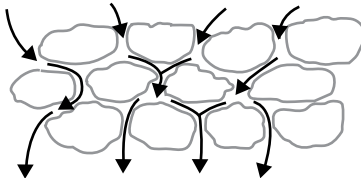
not treated properly, the resultant permeability will be much higher than might otherwise be true. Figure 10D–13 shows the structure that results from compacting soils containing clods that are not adequately broken down.

**Figure 10D–13** Macrostructure in highly plastic clays with poor construction techniques (from Hermann and Elsbury 1987)

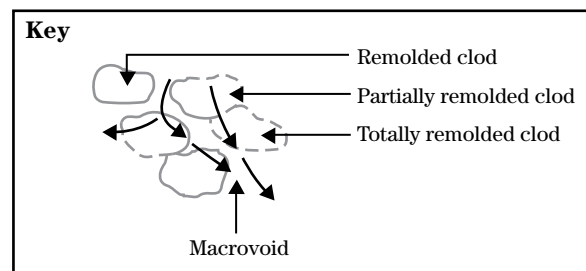
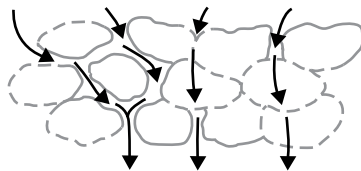
#### Micropermeability



#### Macropermeability



#### Intermediate situation



## Natural water content of borrow

The water content of soils used to construct a clay liner is the most important factor in obtaining a low permeability liner for a given soil. If soils are too dry, they cannot effectively be compacted to a condition where their structure is acceptable and their permeability may be higher than desirable. Compacting a soil at the proper water content creates a structure that is most favorable to a low permeability. Adding water to compacted clay liners is an additional expense that must be considered. A good rule of thumb is that it requires about 3.2 gallons of water to increase the water content of a cubic yard of compacted soil by 1 percent.

### Dry conditions in the borrow

If soils in the borrow area are dry, several problems may need to be addressed. If the soils are clays with relatively high plasticity (PI values greater than about 20), they are likely to be very cloddy when excavated. Water is slow to penetrate the clods and compaction is less likely to degrade clods if enough time has not elapsed between adding the water and compaction. More descriptions follow in subsequent sections, and figure 10D–13 illustrates how clods left in the compacted fill will likely cause the soil to have a higher than expected permeability.

If the water content of borrow soils is more than 3 or 4 percent drier than required for specified compaction conditions, consideration should be given to wetting the soils in the borrow prior to construction. Adding large amounts of water during processing on the fill is difficult and inefficient. Sprinklers can be set up in the borrow some time before construction is planned and then time will allow water to soak into the soils more thoroughly.

### Wet conditions in the borrow

If the natural water content of the borrow soil is significantly higher than optimum water content, achieving the required degree of compaction may be difficult. A good rule of thumb is that a soil will be difficult to compact if its natural water content exceeds about 90 percent of the theoretical saturated water content at the dry density to be attained. The following procedure can help to determine if the soils in the borrow are too wet for effectively compacting them.

*Step 1* Measure the natural water content of the soil to be used as a borrow source for the clay liner being compacted.

*Step 2* Compute the highest dry density to which the soil can be compacted at this water content using the following equation, which assumes that the highest degree of saturation achievable is 90 percent:

$$\text{Achievable } \gamma_{\text{dry}} \text{ lb/ft}^3 = \frac{62.4}{\frac{w_n \%}{90} + \frac{1}{G_s}}$$

where:

$w_n$  (%) = natural water content of borrow soils, %  
 $G_s$  = specific gravity of the soil solids (dimensionless)

Specific gravity values are obtained by ASTM Standard Test Method D854. An average value for specific gravity is often assumed to be 2.68. However, soils with unusual mineralogy may have values significantly different. Soils with volcanic ash may have specific gravity values as low as 2.3, and soils with hematite in them may have values as high as 3.3, based on NRCS laboratory results.

*Step 3* Perform a Standard Proctor (ASTM D698) compaction test on the same soil and determine the maximum dry density value. Compute the achievable degree of compaction by dividing the computed value of achievable dry density by the maximum Standard Proctor dry density.

*Step 4* If the computed achievable degree of compaction is less than 95 percent, then drying of the sample will probably be required. In rare cases, compaction to a lower degree, such as 90 percent of Standard Proctor, at higher water contents will achieve an acceptably low permeability. Laboratory tests should be performed to evaluate whether a lower degree of compaction will result in an acceptable permeability value.

Note: The experience of NRCS engineers is that when the natural water content of a soil is more than 4 percent above optimum water content, it is not possible to achieve 95 percent compaction. Computations should always be performed, as this rule of thumb sometimes has exceptions. In most cases, drying clay soils by only disking is somewhat ineffective, and it is difficult to reduce

their water content by more than 2 or 3 percent with normal effort. It may be more practical to delay construction to a drier part of the year when the borrow source is at a lower water content. In some cases, the borrow area can be drained several months before construction. This would allow gravity drainage to decrease the water content to an acceptable level.

*Step 5* Another way of examining this problem is to assume that soils must be compacted to 95 percent of their Standard Proctor (ASTM D698) dry density and then compute the highest water content at which this density is achievable. Commonly, soils are difficult to compact to a point where they are more than 90 percent saturated. The following equation is used to determine the highest feasible placement water content at which the dry density goal is achievable:

$$\text{Highest placement } w(\%) = \frac{90(\%)}{100} \times \left[ \frac{62.4}{\gamma_{\text{dry}} \text{ lb/ft}^3} - \frac{1}{G_s} \right]$$

#### Example 10D-4—Compute the achievable dry density of a potential borrow source

*Given:*

A borrow source is located and found to be in a desirable group III type soil. The soil has 65 percent finer than the No. 200 sieve and a PI of 18. The soil was sampled and placed in a water tight container and shipped to a soils laboratory. The natural water content of the soil was measured to be 21.8 percent. The lab also performed a specific gravity ( $G_s$ ) test on the soil, and measured a value of 2.72. A Standard Proctor Test was performed on the sample and values for maximum dry density of 108.5 pounds per cubic foot and an optimum water content of 17.0 percent were measured.

*Solution:*

The maximum degree of compaction of this soil at the measured water content. If the soil is too wet to be compacted to 95 percent of maximum standard Proctor dry density, how much will it have to be dried to achieve compaction to 95 percent of maximum density?

$$\text{Achievable } \gamma_{\text{dry}} \text{ lb/ft}^3 = \frac{62.4}{\frac{w_n \%}{90} + \frac{1}{G_s}}$$

$$\text{Achievable } \gamma_{\text{dry}} \text{ lb/ft}^3 = \frac{62.4}{\frac{21.8\%}{90} + \frac{1}{2.72}} = 102.3 \text{ lb/ft}^3$$

Next, compute the achievable degree of compaction by dividing the achievable dry density by the maximum Standard Proctor dry density, expressed as a percentage. The achievable degree of compaction is then equal to 102.3 divided by 108.5×100=94.3 percent.

Now, determine how wet the sample could be and still achieve 95 percent compaction. Ninety-five percent of the maximum Standard Proctor dry density is 0.95×108.5=103.1 pounds per cubic foot. Substitute this value into the equation given:

$$\text{Highest placement } w\% = \frac{90}{100} \times \left[ \frac{62.4}{\gamma_{\text{dry}} \text{ lb/ft}^3} - \frac{1}{G_s} \right]$$

$$\text{Highest placement } w\% = \frac{90}{100} \times \left[ \frac{62.4}{103.1 \text{ lb/ft}^3} - \frac{1}{2.72} \right] = 21.4\%$$

This computation confirms the rule of thumb given that it is difficult to achieve 95 percent degree of compaction if the natural water content is greater than 4 percent above optimum. The stated value for optimum water content is 17.0 percent, so the rule of thumb says that if the natural water content exceeds 21.0 percent, achieving 95 percent degree of compaction will be difficult.

## Methods of excavating and processing clay for liners

### Clods in borrow soil

If borrow soils are plastic clays at a low water content, the soil will probably have large, durable clods. Disking may be effective for some soils at the proper water content, but pulverizer machines may also be required. To attain the highest quality liner, the transported fill should be processed by adding water and then turned with either a disk or a high-speed rotary mixer before using a tamping roller. Equipment requirements depend on the strength and size of clods and the water content of the soil.

### Placement of lifts

Individual lifts of soil usually consist of an equipment width (often about 8 to 10 feet wide) layer of soil about 6 inches thick, after compaction. These lifts should be staggered to prevent preferential flow along the inter-lift boundaries. Figure 10D–14(a) shows the preferred way of offsetting the lifts. Figure 10D–14(b) shows a method that should be avoided. Bonding between the 6-inch lifts is also important so that if water does find its way down the boundary between two lanes of compacted soil that it cannot flow laterally and find the offset boundary.

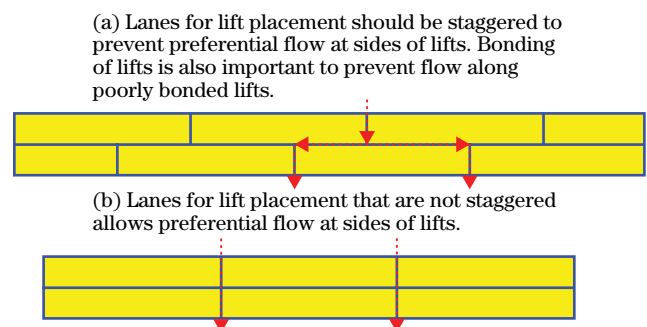
### Macrostructure in plastic clay soils

Clods can create a macrostructure in a soil that results in higher than expected permeability because of preferential flow along the interfaces between clods. Figure 10D–13 illustrates the structure that can result from inadequate wetting and processing of plastic clay. The permeability of intact clay particles may be quite low, but the overall permeability of the mass is high because of flow between the intact particles.

### Dry density and optimum water content

Compaction specifications for most earthfill projects normally require a minimum dry density (usually referenced to a specified compaction test procedure) and an accompanying range of acceptable water contents (referenced to the same compaction test procedure). This method of fill specification is usually based on en-

**Figure 10D–14** Construction methods to limit interlift preferential flow paths





engineering property tests such as shear strength, bearing capacity, and permeability. When permeability is the primary engineering property of interest, as would be the case for a compacted clay liner, an alternative type of compaction specification should be considered. The reason for this is a given permeability value can be attained for many combinations of compacted density and water contents (Daniels and Benson 1990). Figure 10D-15 illustrates a window of compacted dry density and water content in which a given permeability could be obtained for an example soil. The principles involved can be illustrated as follows.

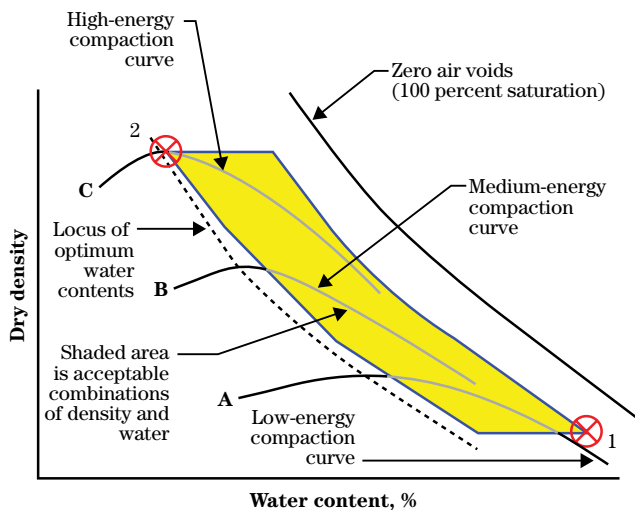
Assume that a given soil is being used to construct a clay liner for an animal waste impoundment. A moderately plastic silty clay classifying as CL in the USCS is used. In case 1, the soil being obtained from a nearby borrow area has a relatively high natural water content. The contractor elects to use lighter construction equipment that applies a relatively low energy in compacting the soil. The result is the soil is compacted to a condition where the compacted density is relatively low and the placement water content is relatively high. This is labeled as point 1 in the figure 10D-15. In case 2, the same soil is being used, but the site is being constructed in a drier time of year. The contractor elects to use a larger sheepsfoot roller and apply more passes of the equipment to achieve the desired product.

This time the same soil is compacted to a significantly higher density at a significantly lower water content. This is labeled point 2 in the figure 10D-15.

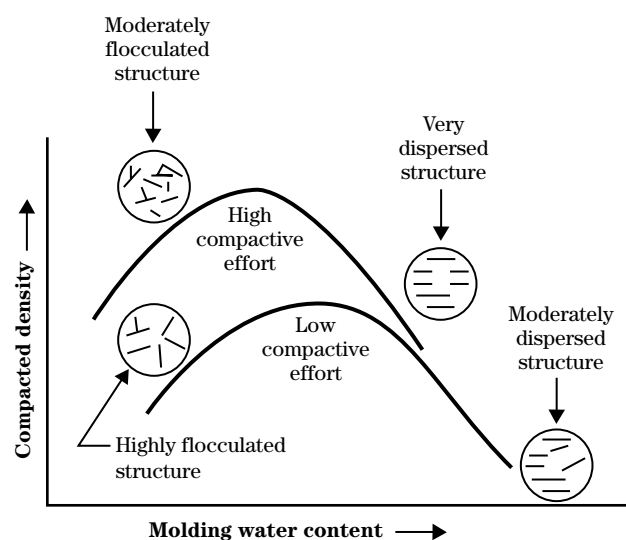
Laboratory tests can be used to establish the boundary conditions and arrive at a window of acceptable densities and water contents for a clay liner. Figure 10D-16 shows how a different structure results between soils compacted wet of optimum and those compacted dry of optimum water content. It also illustrates that soils compacted with a higher compactive effort or energy have a different structure than those compacted with low energy.

Mitchell (1965) was instrumental in explaining how the permeability of clay soils is affected by the conditions under which they were compacted. Figure 10D-17 illustrates results of one series of experiments summarized in the study. Two samples of a soil were compacted using different energy at different water contents and their permeability was measured. Soil C was compacted using higher energy, like that used when a heavy sheepsfoot roller passed over each compacted lift multiple times. Soil B was compacted using a lower energy, equating to a smaller roller with a smaller number of passes used in the compaction process.

**Figure 10D-15** Range at acceptable moisture/density for a typical clay liner



**Figure 10D-16** Effect of water content and compactive effort on remodeling of soil structure in clays (from Lambe 1958)



The curves show the relationship between the permeability of the compacted soil and the compaction water content, for the two energies used. The following general principles are seen:

- The permeability of the low energy soil (curve B) is high unless the compaction water content is significantly wet of optimum. Very high permeability results for compaction dry of optimum.
- The permeability of the higher energy soil (curve C) is relatively high for water contents less than optimum.

Lambe (1958) explains how the energy used and the water content of the soil at the time of compaction affect the permeability of the soil by creating structure in the soil. Figure 10D–16 summarizes his explanation of how different soil structures result from these two factors. Soils compacted with higher energy (heavier equipment and numerous passes of the equipment) at a higher water content have a dispersed structure. This structure creates very small plate-shaped voids that are resistant to water flow. Soils that are compacted with lower energy and/or lower water contents have a flocculated structure. This structure involves larger voids that are more conducive to water flow.

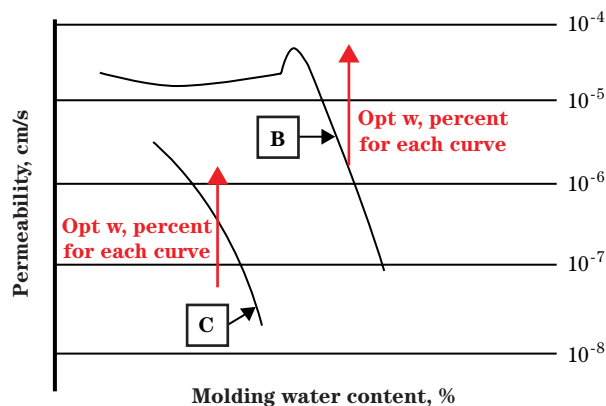
### Percent saturation importance

Benson and Boutwell (2000) studied the correlation between field measured permeability values on compacted liners with laboratory measured values. The study found that when soils were compacted at drier water contents, even if a high density were obtained, that correlation between field and lab permeability test values was poor. The study found good correlation when soils were compacted at relatively higher water contents. Clods in clay soils are probably not broken down as well at lower compaction water contents which explains the higher permeability in the field. In lab tests, breaking down clods and obtaining test specimens without a structure is easier than done with field compaction procedures.

The conclusions of Benson and Boutwell's research were that if a designer is going to rely on laboratory permeability tests to predict the permeability of a compacted clay liner, the following rules of thumb apply.

- Soils should generally be compacted wet of the line of optimums. The line of optimums is illustrated in figure 10D–15. It is the locus of optimum water content values for a given soil for a range of compactive energy. A soil compacted with a low energy (like that resulting from a small sheepfoot roller), curve A in figure 10D–15, will have a relatively low maximum density and high optimum water content. A soil compacted with a high energy (like that resulting from using a large heavy tamping roller), curve C in figure 10D–15, will have a high value for maximum density and a low value of optimum water content. The line of optimums is the locus of points connecting the values of optimum water content. Remember that optimum water content depends on the energy used and that Standard Proctor (ASTM D698) is only one standard type of compaction test. ASTM D1557, the modified energy test is also used for design of some clay liners.
- Eighty percent of field tests of dry density and water content should plot to the right of the line of optimums if the field permeability is expected to reflect the same values obtained in laboratory testing.
- The average water content of all quality control tests should be from 2 to 4 percent wetter than the line of optimums as defined.

**Figure 10D–17** Plot showing effect of molding water content on permeability (Mitchell 1965)



## Energy level of compaction

The relationship of maximum dry density and optimum water content varies with the compactive energy used to compact a soil. Higher compactive energy results in higher values of maximum dry unit weight and lower values of optimum water content. Lower compactive energy results in lower values of maximum dry unit weight and higher values of optimum water content. Because optimum water content varies with the energy used in compaction, its nomenclature can be misleading. The optimum water content of a soil varies with the particular energy used in the test to measure it.

Compactive energy is a function of the weight of the roller used, thickness of the lift, and number of passes of the roller over each lift. Rollers should be heavy enough to cause the projections (teeth or pads) on the roller to penetrate or almost penetrate the compacted lift. Enough passes must be used to attain coverage and break up any clods. Additional passes do not compensate for rollers that are too light.

Roller size is often specified in terms of contact pressure exerted by the feet on sheepfoot or tamping rollers. Light rollers have contact pressures less than 200 pounds per square inch, while heavy rollers have contact pressures greater than 400 pounds per square inch.

Limited data are available for various sizes of equipment to correlate the number of passes required to attain different degrees of compaction. Typically, from 4 to 8 passes of a tamping roller with feet contact pressures of 200 to 400 pounds per square inch are required to attain degrees of compaction of from 90 to 100 percent of maximum Standard Proctor dry density. However, this may vary widely with the soil type and weight of roller used. Specific site testing should be used when possible.

## Equipment considerations

### Size and shape of teeth on roller

Older style sheepfoot-type projections on rollers are best suited for compacting clay soils to achieve the lowest possible permeability. They are better suited than the modern style rollers called tamping rollers

that have more square, larger area projections. The longer teeth on the older style sheepfoot rollers are better at remolding plastic clay soils that are wet of optimum water content, and they are better at degrading clods in the soils (fig. 10D–18). The modern tamping-type rollers are effective in compacting soils at a drier water content when high bearing capacity is needed, like soils being compacted for highway subgrades (fig. 10D–19). The older style of sheepfoot roller compactors are better suited for compaction to achieve low permeability.

### Total weight of roller

To attain penetration of the specified loose lift, the roller weight must be appropriate to the specified thickness and the shape of the roller projections. Many modern rollers are too heavy to compact soils that are more than 1 or 2 percent wet of optimum water content. When the specified compaction water content is 2 percent or more wet of optimum water content, lighter rollers are essential. Permeability of clays is minimized by compaction at water contents wet of optimum.

### Speed of operation

Heavy rollers operated at excessive speed can shear the soil lifts being compacted, which may result in higher permeability. Close inspection of construction operations should indicate if this problem is occurring, and adjustments to equipment or the mode of operation should then be made.

### Vibratory versus nonvibratory sheepfoot and tamping rollers

Some sheepfoot and tamping rollers have an added feature, a vibratory action. This feature can usually be activated or deactivated while soils are being compacted. Vibratory energy adds little to the effectiveness of these rollers when the soils being compacted are clays. At the same time, the vibration of the equipment is not usually detrimental. One condition in which the vibratory energy of this type of equipment might be detrimental is when a clay liner is being constructed on a subgrade of low plasticity silts or sands that are saturated. The vibration of the equipment often causes these types of foundation soils to become dilatant as they densify, and the water expelled in this process can create a trafficability problem. For this reason, when subgrade soils are saturated low plasticity silts

and sands, the vibratory action of the compaction equipment should be disabled.

### Vibratory smooth-wheeled rollers

Vibratory smooth-wheeled rollers are well suited to compacting bentonite-treated liners. They should not be used for compacting clay liners, however. The smooth surface of the roller results in poor bonding between lifts and can cause problems like those shown in figure 10D-14. The load distribution of the rollers also causes the top of a lift to be compacted well but the bottom of the lift not as well, when fine-grained soils are being compacted. A vibratory smooth wheeled roller is shown in figure 10D-20.

**Figure 10D-18** Longer style of teeth preferable for compacting soils for clay liner



**Figure 10D-19** Modern type of tamping roller less well suited for compacting soils for clay liner



## Freeze-thaw and desiccation

### Freeze-thaw

Compacted clay liners may become damaged when the liner is exposed during freezing weather. Articles by Kim and Daniel (1992) and Benson and Othman (1993) describe the effects of freezing on clay liners and how the damage resulting from freezing may be permanent. Laboratory tests show that permeability rates may increase by 2 to 3 orders of magnitude (100–1,000 times). Freeze-thaw damage is more likely to affect the side slopes of a clay-lined pond than it will the bottom of the pond after it is filled. If freeze-thaw damage is regarded as likely to increase the permeability of the

**Figure 10D-20** Smooth-wheeled steel roller compactor



soils on the side slopes of the pond, a thicker liner or protective cap of cover soil should be considered. The extra cost of freeze-thaw protection may cause a designer to consider a synthetic liner alternative for reasons of economy and confidence in the low permeability of the synthetic liner. For instance, Minnesota designs often include the use of GCL liners for this reason.

### Desiccation

Compacted clay liners may also be damaged when the liner is exposed during hot, dry weather after construction and before the pond is filled. Desiccation may also occur during periods the pond is emptied. Articles by Daniel and Wu (1993) and Kleppe and Olson (1985) describe factors that affect desiccation. Using the sandiest soil available that will be adequately impermeable is helpful. Compacting the soil as dense and dry as practical while still achieving the design permeability goal is also helpful. Protective layers must be at least 12 inches thick to be effective, and even thicker layers may be needed for more plastic clay liners, those with PI values of 30 or higher.

## Design and construction of bentonite amended liners

When soils at grade of an excavated pond are low plasticity sands and silts in groups I or II of table 10D–3, an unlined pond will result in unacceptably high seepage losses. Several design options are normally considered for this situation. The options are listed as follows in order of increasing cost:

- Clay soils suitable for a clay liner are located in a nearby borrow area and imported to the site to construct a compacted clay liner. CPS 521D applies to this practice.
- Soils from the excavation and at the excavated subgrade are treated with bentonite to create a compacted liner with the required permeability and thickness. CPS 521C applies to this practice.
- The pond may be lined with geosynthetic, a GCL, or lined with concrete. An aboveground storage tank is also an option.

## Bentonite type and quality

Several types of bentonite are mined and marketed for use in treating soils to produce a low permeability liner. The most effective type of bentonite (less volume required per cubic foot of treated soil) is finely ground sodium bentonite that is mined in the area of northeast Wyoming, southeast Montana, and western South Dakota. This sodium bentonite is derived from weathered volcanic ash. Sodium bentonite is a smectite clay composed primarily of the mineral montmorillonite (Bentofix 2007). It has the ability to swell up to 10 to 15 times its dry natural volume when exposed to water. Other types of bentonite, usually calcium bentonite are also mined and marketed for treating soils. These types of bentonites are less active (less free swell potential) and more volume of bentonite per treated cubic yard of soil will be required to produce a target permeability than would be required if sodium bentonite were used.

Two methods of evaluating a bentonite source being considered for use as an additive for a liner has high swell properties exist. They are:

- Determine the level of activity based on its Atterberg limit values as determined in a soil testing laboratory. High-quality sodium bentonite has LL values greater than 600 and PI values greater than 550.
- High-quality sodium bentonite has a free swell value of 22 milliliter or higher, based on experience of NRCS engineers and generally accepted guidance. An ASTM Standard test method to evaluate the free swell potential of bentonite is used to verify the quality of bentonite used in GCL liners and is also suitable for evaluating bentonite proposed for a liner being constructed using CPS 521C. The ASTM method is D5890. A summary of the method follows.
  - Prepare a sample for testing that consists of material from the total sample that is smaller than a No. 100 sieve.
  - Partially fill a 100-milliliter graduated cylinder with 90 milliliters of distilled water.
  - Add 2 grams of bentonite in small increments to the cylinder. The bentonite will sink to the bottom of the cylinder and



swell as it hydrates. Wash the sides of the cylinder and fill to the 100-milliliter level.

- After 2 hours, inspect the hydrating bentonite column for trapped air or water separation in the column. If present, gently tip the cylinder at a 45-degree angle and roll slowly to homogenize the settled bentonite mass.
- After 16 hours from the time the last of sample was added to the cylinder, record the volume level in milliliters at the top of the settled bentonite. Record the volume of free swell, for example, 22 milliliters free swell in 24 hours.

Figure 10D–21 shows an excellent quality bentonite reaction to the test. It has a free swell of about 27 milliliters.

Bentonite is furnished in a range of particle sizes for different uses. Fineness provided by the bentonite industry ranges from very finely ground, with most particles finer than a No. 200 sieve, to a granular form, with particles about the size of a No. 40 sieve. Laboratory permeability tests have shown that even though the same bentonite is applied at the same volumetric rate to a sample, a dramatic difference in the resulting permeability can occur between a fine and a coarse bentonite. It is important to use in construction the same quality and fineness as was used by the soils laboratory for the permeability tests to arrive at rec-

**Figure 10D–21** Free swell test for bentonite ASTM D5890



ommendations. Fineness for use in treating liners for waste impoundment can also be specified by an acceptable bentonite by supplier and designation, or equivalent. An example specification is Wyo Ben type Envirogel 200, CETCO type BS–1, or equivalent.

### Design details for bentonite liner

The criteria given in CPS 521C, Pond Sealing or Lining, Bentonite Treatment, provide minimum required liner thicknesses for various depth of liquids.

CPS 521C provides guidance on rates of application of bentonite for preliminary planning purposes or where the size and scope of the project does not warrant obtaining samples and having laboratory tests performed. These preliminary recommended rates of application are based on using high-quality sodium bentonite that is finely ground. The CPS 521C includes a table that shows a range of recommended application rates which vary with the type of soil being treated. Higher rates of application are needed for coarse, clean sands and lower rates for silts. The table shows a recommended application rate expressed in pounds of bentonite per square foot per inch of liner to be built. For example, a typical rate of application for a relatively clean sand would be about 0.625 pounds per square foot per inch of compacted bentonite-treated liner. The most up-to-date CPS 521C should always be consulted for recommended rates, in case they have changed since this document was written.

For planning purposes, using these recommended rates, the amount of bentonite needed for a job can be estimated. For example, assume that a pond is to be constructed with an area of the sides and bottom totaling one acre. Assume that considering the planned depth of water in the pond, a design has been formulated that calls for a 1-foot-thick bentonite-treated liner and that an application rate of 0.625 pounds per square foot per inch is needed. The total amount of bentonite required per square foot will be

$$0.625 \text{ lb/ft}^2 \times 12 \text{ in/ft} = 7.5 \text{ lb}$$

of bentonite per square foot. For an acre of pond area, the total amount needed will be

$$7.5 \text{ lb/ft}^2 \times 43,560 \text{ ft}^2/\text{acre} = 326,700 \text{ lb} \\ = 163 \text{ tons}$$

The cost of bentonite is affected strongly by freight, and the further a site is from the area of the United States where bentonite is produced, the more costly it will be. Better unit prices are available for larger quantities.

Remember that the preliminary rates of application provided in CPS 521C assume that finely ground high-swell sodium bentonite is used. If plans anticipate that a lower quality bentonite with a free swell less than about 22 milliliters or a coarsely ground bentonite may be used, laboratory testing is required to establish a rate of application that will create a suitably low permeability. Design using the specific discharge approach will establish what the target permeability value should be.

The recommended procedure to arrive at a design for a bentonite-treated liner then is as follows:

*Step 1* Obtain a sample of the soil to which the bentonite is to be added. Have the sample tested in a soils laboratory to determine its basic index properties, including percent fines and plasticity.

*Step 2* Have a standard Proctor (ASTM D698) test performed to determine the maximum dry density and optimum water content.

*Step 3* From the preliminary design of the site, determine the depth of water in the structure. Use CPS 521C to determine the minimum thickness of liner required.

*Step 4* Using given or assumed values for allowable specific discharge, compute the required permeability of the bentonite-treated liner.

*Step 5* Coordinate with a soils laboratory on testing to determine what degree of compaction, water content, and rate of application of the proposed additive is required to obtain this permeability. Consider whether high quality (free swell > 22 mL) is being used and whether finely ground or coarsely ground bentonite is proposed.

*Step 6* Design the final liner based on the results of step 5.

### Example 10D–5—Design of a bentonite-treated liner

*Given:*

A waste storage pond is planned with a depth of liquid

of 21 feet. The State requirement for the location is a specific discharge no greater than one-fifty-sixth of an inch per day of seepage. Assume the soils at grade have been tested and found to be suitable for bentonite treatment. Find the minimum thickness liner required according to CPS 521C, and determine the required permeability to meet this specific discharge requirement.

First, consult CPS 521C to determine the minimum required thickness. Assume the current CPS requires a liner that is 18 inches thick (1.5 ft).

Convert the specified unit seepage rate (specific discharge) of one-fifty-sixth of an inch per day into the same units as will be used for permeability (centimeters per second). To convert, use conversion values shown in table 10D–6, multiply:

$$v = \frac{1}{56} \text{ in/d} \times 2.94 \times 10^{-5} = 5.25 \times 10^{-7} \text{ cm/s}$$

The thickness of the liner and depth of liquid in the pond must also be converted to metric units. To convert the liner thickness of 18 inches to centimeters, multiply by 2.54, which equals a liner thickness,  $d$ , of 45.72 centimeters. The liquid depth,  $H$ , of 21 feet is equal to

$$H = 21 \text{ ft} \times 12 \text{ in/ft} \times 2.54 \text{ cm/in} = 640.1 \text{ cm}$$

Using the equation described previously, solve for the required permeability:

$$k = \frac{v \times d}{H + d}$$

$$k = \frac{5.25 \times 10^{-7} \text{ cm/s} \times 45.72 \text{ cm}}{640.1 \text{ cm} + 45.72 \text{ cm}} = 3.5 \times 10^{-8} \text{ cm/s}$$

The designer should coordinate with a soils laboratory to determine how much bentonite of given quality is required to obtain this low a permeability. In the experience of NRCS engineers, relying on this low a permeability means that construction quality control must be excellent and all the procedures and materials used are of highest quality. Seldom should designs for clay liners rely on a design permeability much lower than  $5 \times 10^{-8}$  centimeters per second. A designer might want to proceed with this design but require a slightly thicker liner (24 in) to provide additional assurance of obtaining the design specific discharge.

## Considerations for protective cover

CPS 521C recommends considering the addition of a protective soil cover over the bentonite-treated compacted liner in waste impoundments. There are several reasons why a soil cover should be provided:

- Desiccation cracking of the liner after construction and prior to filling is a significant problem because the bentonite used in treatment is highly plastic.
- Desiccation cracking of the liner on the side slopes may occur during periods when the impoundment is drawn down for waste utilization or sludge removal. Desiccation cracking would significantly change the permeability of the liner. Rewetting generally does not completely heal the cracks.
- Bentonite-treated liners are generally thinner than compacted clay liners. Because the liner is thin, it can be more easily damaged by erosion from rainfall and runoff while the pond is empty. Rills in a thin liner provide a direct pathway for seepage.
- Over excavation by mechanical equipment during sludge removal can damage the liner. A minimum thickness of 12 inches measured normal to the slope and bottom is recommended for a protective cover. The protective cover should be compacted to reduce its erodibility.

## Construction specifications for bentonite liner

The best equipment for compacting bentonite-treated liners is smooth-wheeled steel rollers, as shown in figure 10D–20. Crawler tractor treads are also effective. Sheepsfoot rollers that are often used in constructing clay liners are not as effective. CPS 521C specifies that for mixed layers, the material shall be thoroughly mixed to the specified depth with disk, rototiller, or similar equipment. In addition, intimate mixing of the bentonite is essential to constructing an effective liner. If a standard disk is used, several passes should be specified. A high-speed rotary mixer is the best method of obtaining the desired mix (fig. 10D–22). A minimum of two passes of the equipment is recommended to assure good mixing. When multiple passes of equipment are used for applying and mixing the bentonite, the

passes should be in directions perpendicular to each other. This encourages a more homogeneous mixture.

Another construction consideration is the moisture condition of the soil into which the bentonite is to be mixed. Unless the soil is somewhat dry, the bentonite will most likely ball up and be difficult to thoroughly mix. Ideally, bentonite should be spread on a relatively dry soil, mixed thoroughly, then watered and compacted.

Depending on the type of equipment used, tearing of the liner during compaction can occur on slopes of 3H:1V or steeper. Compacting along, rather than up and down slopes, could be unsafe on 3H:1V or steeper side slopes. For most sites, slopes of 3.5H:1V or 4H:1V should be considered.

Bentonite-treated liners are often constructed in lifts that are 4-inch compacted thickness. Liners should be designed in multiples of 4 inches for this reason. Often, the first layer of bentonite-treated soil is the soil exposed in the bottom of the excavation. By applying bentonite to the exposed grade, diking it in to a depth of about 6 inches, and compacting it, the first layer is formed. Subsequent lifts are formed by importing loose fill adequate to form additional 4-inch-thick lifts.

**Figure 10D–22** Pulvermixer (high-speed rotary mixer)  
(Photo credit Stacy Modelski, NRCS)





## Design and construction of clay liners treated with soil dispersants

Previous sections of this appendix caution that soils in groups III and IV containing high amounts of calcium may be more permeable than indicated by the percent fines and PI values. Groups III and IV soils predominated by calcium usually require some type of treatment to serve as an acceptable liner. The most common method of treatment to reduce the permeability of these soils is use of a soil dispersant additive containing sodium.

### Types of dispersants

The dispersants most commonly used to treat high calcium clays are soda ash ( $\text{Na}_2\text{CO}_3$ ) and polyphosphates. The two most common polyphosphates are tetrasodium pyrophosphate (TSPP), and sodium tripolyphosphate (STPP). Common salt (NaCl) has been used in the past, but it is considered less permanent than other chemicals and is not permitted in the current CPS 521B. NRCS experience has shown that usually about twice as much soda ash is required to effectively treat a given clay when compared to the other two dispersants. However, because soda ash is often less expensive, it may be the most economical choice in many applications.

### Design details for dispersant-treated clay liner

CPS 521B, Pond Sealing or Lining, Soil Dispersant, provides minimum thicknesses of liners using the dispersant-treated layer method, based on the depth of liquid in the pond. CPS 521B provides guidance on approximate rates of application of soil dispersants based on testing performed by the NRCS laboratories. Rates provided in the CPS are in terms of pounds of dispersant required per 100 square feet for each 6-inch layer of liner. The total amount of dispersant per 100 square feet is then equal to the number of 6-inch lifts in the completed liner multiplied by the rate per lift.

### Example 10D–6—Steps in design of a dispersant-treated liner

Assume for the purposes of this example that a soil has been tested at a site and found to be a flocculated clay with an unacceptably high permeability. The designer chooses to evaluate a soda ash-treated liner. Consult the current CPS 521B for guidance on application rates for soda ash. Assume that the current CPS suggests an application rate of 15 pounds of soda ash per 100 square feet of liner for each 6-inch-thick lift of finished liner. Next, assume that based on the depth of water in the pond that the CPS 521B requires a total liner thickness of 12 inches. Then, because each 6-inch-thick lift requires 15 pounds of soda ash per 100 square feet, the total amount of soda ash required for this example would be 30 pounds of soda ash per 100 square feet. The most up-to-date CPS 521B should always be consulted for recommended rates, in case they have changed since this document was written.

The recommended rates of application of dispersants in CPS 521B are based on the most up-to-date information from the NRCS soils testing laboratories. The rates are in general conservative, and if a designer wanted to evaluate lower rates of application, samples should be obtained and sent to a laboratory for documenting the efficacy of lower rates. If this procedure is followed, the following steps are usually implemented.

*Step 1* Obtain a sample of the soil to which the dispersant is to be added. Have the sample tested in a soils laboratory to determine its basic index properties, including percent fines and plasticity.

*Step 2* A standard Proctor (ASTM D698) test is performed to determine the maximum dry density and optimum water content.

*Step 3* From the preliminary design of the site, determine the depth of water in the structure and use CPS 521B to determine the minimum thickness of liner required.

*Step 4* Using given or assumed values for allowable specific discharge, compute the required permeability of the dispersant-treated liner.

*Step 5* Coordinate with a soils laboratory on testing to determine what degree of compaction, water content, and rate of application of the proposed additive is required to obtain this permeability. Consider local practice and consult sup-

pliers to determine the relative costs of soda ash versus polyphosphates.

*Step 6* Design the final liner based on the results from previous steps.

### Example 10D-7—Comprehensive example for a dispersant-treated liner

*Given:*

A waste storage pond is planned with a depth of liquid of 18 feet. The State requirement for the location is a specific discharge no greater than 2,000 gallons per acre per day of seepage. Assume the soils at grade have been tested and found to require dispersant treatment. Assume that the current CPS 521B requires a minimum liner thickness of 1.5 feet. The example problem is to determine what permeability is required to meet the stated specific discharge requirement.

*Solution:*

First, the required specific discharge value, which is given in units of gallons per acre per day has to be converted the same units that will be used for required permeability. Assume that permeability will be expressed in centimeters per second, so use table 10D-6 to convert the value of 2,000 gallons per acre per day to centimeters per second as follows:

$$v = \frac{2,000 \text{ gal/acre/d}}{9.24 \times 10^8} = 2.2 \times 10^{-6} \text{ cm/s}$$

Next, convert the liner thickness and depth of liquid from units of feet to centimeters:

$$d = 18 \text{ in} \times 2.54 \text{ cm/in} = 45.72 \text{ cm}$$

$$H = 18 \text{ ft} \times 12 \times 2.54 \text{ cm/ft} = 548.64 \text{ cm}$$

Using the equation described previously, solve for the required permeability:

$$\begin{aligned} k &= \frac{v \times d}{H + d} \\ &= \frac{2.2 \times 10^{-6} \text{ cm/s} \times 45.72 \text{ cm}}{548.64 \text{ cm} + 45.72 \text{ cm}} \\ &= 1.7 \times 10^{-7} \text{ cm/s} \end{aligned}$$

The designer should coordinate with a soils laboratory to determine how much soil dispersant of the desired type is required to obtain this low a permeability. In the experience of NRCS engineers, obtaining this value of permeability using a soil dispersant should not re-

quire special effort or unusual amounts of additive. At the same time, seldom should designs for dispersant-treated clay liners rely on a design permeability much lower than  $5 \times 10^{-8}$  centimeters per second. A designer should proceed with this design specifying the application rate recommended by the soils lab and a 1.5-foot-thick liner to obtain the design specific discharge.

### Construction specifications for a dispersant-treated clay liner

The best equipment for compacting clays treated with dispersants is a sheepsfoot or tamping type of roller. CPS 521B specifies that the material shall be thoroughly mixed to the specified depth with a disk, high speed rotary mixer, or similar equipment. Because small quantities of soil dispersants are commonly used, uniform mixing of the dispersants is essential to constructing an effective liner. If a standard disk plow is used, several passes should be specified. A high-speed rotary mixer is also essential to obtain a thorough mixture of the dispersant with the clay being amended. Figure 10D-23 shows this type of equipment. At least two passes of the equipment is recommended to assure good mixing.

Other construction considerations are also important. Using the bathtub method of construction on slopes of 3H:1V or steeper can cause tearing of the liner during compaction and reduce the effectiveness of compac-

**Figure 10D-23** High-speed rotary mixer used to mix dispersants into clays (Photo credit Jody Kraenzel, NRCS)



tion equipment. Slopes as flat as 3.5H:1V or 4H:1V should be considered for this factor alone, for bathtub type construction.

Current CPSs usually require a liner thicker than 6 inches. A liner generally can be satisfactorily constructed in a series of lifts by mixing in the required amount of soil dispersant to a 9-inch-thick loose depth and then compacting it to the 6 inches. Thicker liners should be constructed in multiple lifts, with the final compacted thickness of each lift being no greater than 6 inches.

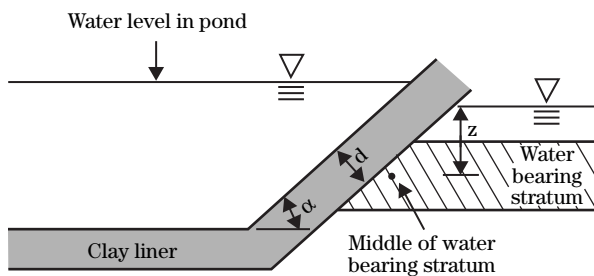
## Uplift pressures beneath clay blankets

A clay blanket may be subject to uplift pressure from a seasonal high water table in the foundation soil underneath the clay liner. The uplift pressure in these cases can exceed the weight of the clay liner, and failure in the clay blanket can occur (fig. 10D–24). This problem is most likely to occur during the period before the waste impoundment is filled and during periods when the impoundment may be emptied for maintenance and cleaning. Figure 10D–25 illustrates the parameters involved in calculating uplift pressures for a clay blanket. The most critical condition for analysis typically occurs when the pond is emptied. Thicker blankets to attain a satisfactory safety factor should be used if they are required.

**Figure 10D–24** Failure of compacted liner from uplift forces below clay blanket (*Photo credits NRCS, TX*)



**Figure 10D–25** Uplift calculations for high water table and clay blanket (from Oakley 1987)



The factor of safety against uplift is the ratio of the pressure exerted by a column of soil to the pressure of the ground water under the liner. It is given by the equation:

$$FS = \frac{\gamma_{\text{sat}} \times d \times \cos(\alpha)}{z \times \gamma_{\text{water}}}$$

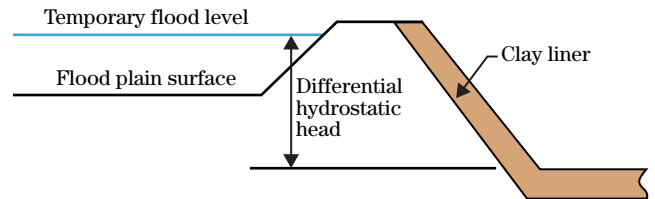
where:

- d = thickness of liner, measured normal to the slope
- $\alpha$  = slope angle
- $\gamma_{\text{water}}$  = unit weight or density of water
- $\gamma_{\text{sat}}$  = saturated unit weight of clay liner
- z = vertical distance from middle of clay liner to the seasonal high water table

A factor of safety of at least 1.1 should be attained. The safety factor can be increased by using a thicker blanket or providing some means of intercepting the ground water gradient and lowering the potential head behind the blanket. Often, sites where seasonal high water tables are anticipated designs include a perimeter drain to collect the water and prevent this type of damage. Another option is a concrete structure above ground.

Another situation where a clay liner may be damaged from hydrostatic pressure is one where a site is located in a flood plain of a stream or river. The site may have to be built above ground level in this location to avoid a seasonal high water table. Figure 10D-26 illustrates the problem that may occur that must be considered by designers. A temporary flood condition in the flood plain can subject the agricultural waste impoundment to a differential head when the pond is empty. The pond could be empty shortly following construction or it could be empty to apply waste to crops. Uplift pressure may cause piping of sandy horizons underlying the site and boils, and sloughing of side slopes can occur as shown in figure 10D-26. The photo shows a clay-lined animal waste impoundment where the clay liner was damaged from excessive hydrostatic uplift forces caused by temporary storage of flood waters outside the embankment. The liner must be thick enough to resist predicted buoyant forces if it is possible for the pond to be empty or near empty during a flood. Drains will be ineffective because in a flood, outlets will be submerged.

**Figure 10D-26** Uplift conditions caused by temporary flood stage outside lagoon (Photo credit NRCS, WA)





## Perimeter drains for animal waste storage ponds

When a high water table is anticipated and uplift pressures are anticipated, one approach to solving the problem is to install a drain around the pond. The drain may completely encircle the pond if a designer anticipates a general elevated water table in the site vicinity. At other sites with a more sloping ground surface, the perimeter drain may only be installed on the side(s) of the impoundment where the elevated water table is anticipated. Drains may be used both for clay liners and geosynthetic liners.

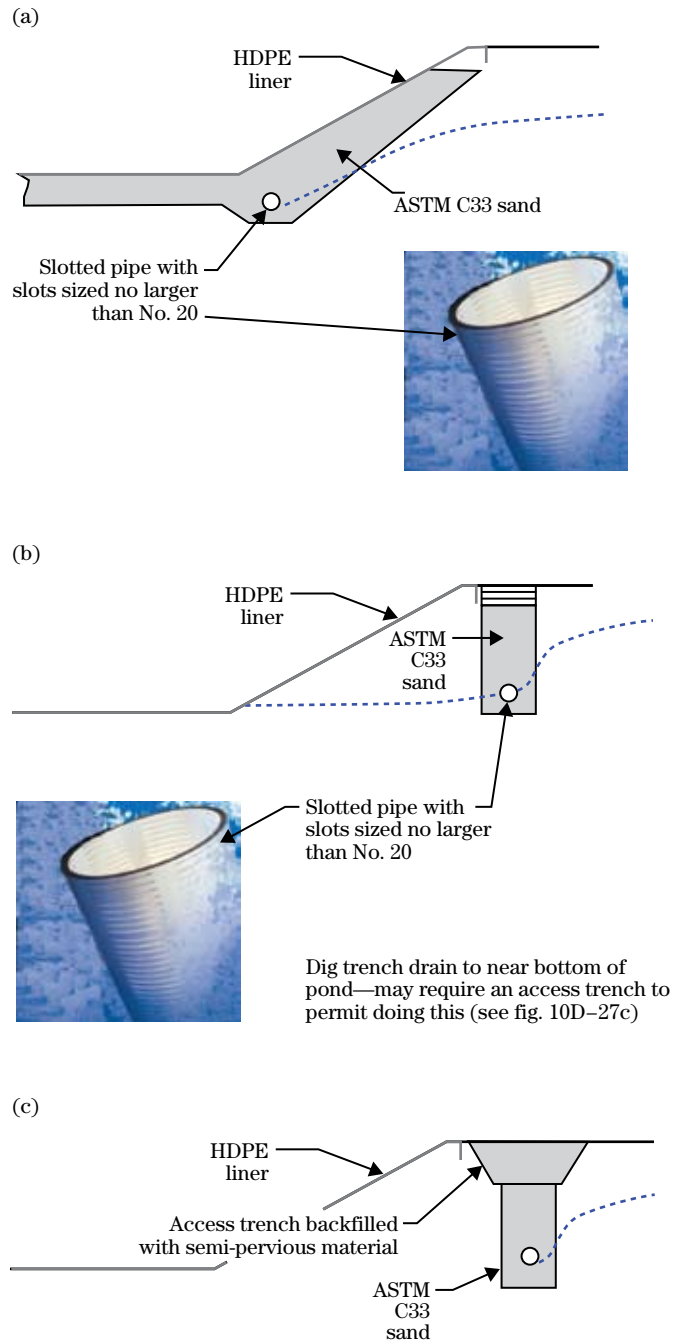
Drains usually are constructed by

- digging a trench to the depth needed to draw down the water table
- placing a perforated or slotted drainage pipe
- surrounding the drain with granular material that is compatible with both the slot size in the pipe and the gradation of the surrounding foundation soils

Pipes with small slots that are compatible with a filter sand like ASTM C-33 are preferred to avoid having to use two filter gradations. If pipes with larger perforations are used, they should be surrounded with gravel to prevent particles from moving into the pipe. Figure 10D-27 (a, b, and c) show typical installations where a single filter and perforated pipe is used. Another approach to installing a drain is to dig a trench, line it with geotextile, and after putting a slotted collector pipe in the trench, filling it with gravel. Figure 10D-28 shows this type of installation.

Several types of drain pipe may be used. One type is a low strength corrugated pipe with slots or perforations surrounded by a filter envelope of granular material. Figure 10D-29 is an example of this type of collector pipe. If a higher strength pipe is required, figure 10D-30 shows another type of pipe that is sometimes used for these types of installations.

**Figure 10D-27** Typical drain installations using single filter with well-screened collector pipe



Illustrated access trench construction to permit installing deeper trench drain. Access trench filled with semi-pervious soil to limit infiltration of surface runoff.

**Figure 10D-28** Perforated collector pipe installed the gravel envelope with trench lined with geotextile



**Figure 10D-30** Corrugated drainage pipe with slots, doubled walled pipes may be specified if higher strengths are needed



**Figure 10D-29** Low-strength perforated drainage tubes



## Soil mechanics testing for documentation

Laboratory soil testing may be required by regulations for design, or a designer may not choose to rely on correlated permeability test values. The NRCS National Soil Mechanics Center Laboratories have the capability to perform the necessary tests. Similar testing is also available at many commercial labs. The

accepted method of permeability testing is by ASTM Standard Test Method D5084, Measurement of Hydraulic Conductivity of Saturated Porous Materials Using a Flexible Wall Permeameter. Figure 10D–31 shows the equipment used for performing the test.

Contact the labs for more detailed information on documentation needed and for procedures for submitting samples.

**Figure 10D–31** Equipment used for performing ASTM D5084



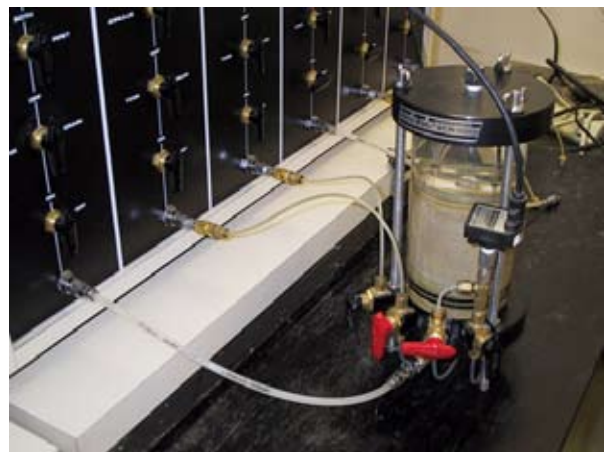
Molding a sample for a flexible wall permeability test



Disassembled mold with compacted specimen



Preparing sample in cell for flexible wall permeability test



Molded sample after dissembling mold



If the only tests requested are gradation and Atterberg limit tests, smaller samples are needed. The size of sample that should be submitted depends on the gravel content. The following recommendations should be adhered to:

Estimated gravel content of the sample <sup>1/</sup> (%)	Sample moist weight (lb)
0–10	5
10–50	20
>50	40

1/ The sample includes the gravel plus the soil material that passes the No. 4 sieve (approx. 1/4-inch mesh).

If gradation analysis, Atterberg limits, compaction, and permeability testing are requested, considerably larger samples are required. When all these tests are needed, the sample size should be as follows:

Estimated gravel content of the sample <sup>1/</sup> (%)	Sample moist weight (lb)
0–10	50
10–50	75
>50	100

1/ The sample includes the gravel plus the soil material that passes the No. 4 sieve (approx. 1/4-inch mesh).

Submitting samples at their natural water content is important so designers can compare the natural water content to reference compaction test values. Samples should always be shipped in moisture proof containers for this reason. The best container for this purpose is a 5-gallon plastic pail commonly obtained in hardware stores. These pails have tight fitting lids with a rubber gasket that ensures maintenance of the water content in the samples during shipping. These 5-gallon pail containers are much more robust and less likely to be damaged during shipment than cardboard containers.

If designs rely on a minimum degree of compaction and water content to achieve stated permeability goals in a clay liner, testing of the clay liner during construction may be advisable to verify that design goals have been achieved. Field density and water content measurements are routinely made using procedures shown in NEH, Section 19, Construction Inspection.

## Other methods for documenting liner seepage

Performing density/water content tests during construction is a generally accepted method of documenting that a clay liner has been constructed according to specifications. If the liner is found to meet the requirements of the compaction specifications, the assumption is that the permeability values documented from laboratory testing on samples that were compacted at the specified density and water content will be achieved. In some cases, no additional documentation is required. In other cases, regulations require obtaining samples of the completed liner and performing permeability tests on them. Figure 10D–32 shows one way that a Shelby tube type of sample may be obtained without mobilizing a drilling rig. The Shelby tube used is typically a standard tube with a 3-inch outside diameter and 2 7/8-inch inside diameter. This size sample can be placed directly in a flexible wall permeameter for testing, after extrusion in the laboratory.

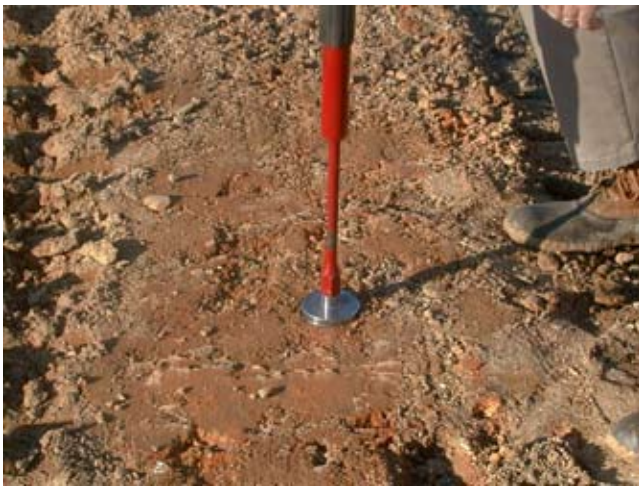
Another method for obtaining a sample of a compacted clay liner is with a drive sampler like that shown in figure 10D–33.

**Figure 10D–32** Shelby tube sample being obtained with backhoe bucket used to force tube into clay liner (Photo credit Jody Kraenzel, NRCS, NE)





**Figure 10D-33** Obtaining undisturbed sample of compacted clay liner using thin-walled drive cylinder



In the situation where a storage pond was constructed several years before documentation on quality of construction and permeability was required, studies are sometimes made in an attempt to measure seepage losses directly. One approach that has been used was developed by researchers at Kansas State University. This approach involves installing precise water level monitoring devices and evaporation stations. Seepage losses can be estimated by carefully monitoring the levels in the pond during periods when no waste is introduced into the pond and no rainfall occurs. After estimating the amount of evaporation, and subtracting that from the total decline in the level of the pond during that period, seepage loss can be estimated. Figure 10D-34 shows equipment for measuring evaporation in a pond.

**Figure 10D-34** Equipment used to monitor evaporation at an agriculture waste storage lagoon. Measurements are used in total lagoon seepage evaluations.



## Summary

- The reduction in the quantity of seepage that occurs as manure solids accumulate in the bottom and on the sides of storage ponds and treatment lagoons is well documented. However, manure sealing is not effective for soils with a low clay content. Its effectiveness is not accepted by all designers and cannot be used in the designs of storage ponds by some State and local regulations.
- Soils can be divided into four permeability groups based on their percent fines (percent finer than the No. 200 sieve) and plasticity index (PI). Soils in groups III and IV may be assumed to have a coefficient of permeability of  $1 \times 10^{-6}$  centimeters per second or lower unless they have an unusual clay chemistry (high calcium), or they have a very blocky structure.
- Group I soils will generally require a liner. Soils in group II will need permeability tests or other documentation to determine whether a desirable permeability rate can be achieved for a particular soil.
- If natural clay blankets are present at a site below planned grade of an excavated pond, the seepage rate should be estimated based on measured or estimated permeability values of the low permeability horizons beneath the liner and above an aquifer. If the estimated seepage rate is less than that given in NRCS guidance or State regulations, no special compacted liner may be required. If the soils at grade are not of sufficient thickness and permeability to produce a desirably low seepage rate, a liner should be designed to achieve the seepage rate that is the design goal.
- Guidance is given on factors to consider whether a constructed liner may be required. Four conditions are listed in which a liner should definitely be considered.
- Allowable specific discharge values are discussed and guidance is provided on reasonable values to use for design when other regulatory requirements are not specified.
- Flexibility is built into the design process. The depth of the liquid, the permeability, and thick-

ness of the soil liner can be varied to provide an acceptable specific discharge.

- The guidelines provided for design of clay liners in this appendix provide designers with the tools to evaluate the probable unit seepage or specific discharge through a clay liner. The methods presented allow a designer to determine what treatment is required to achieve specific discharge or permeability goals.
- Methods provide designers with the ability to evaluate the effect of changes in a proposed design on the estimated unit seepage rate.
- As additional research becomes available, practice standards and guidance in this document may warrant revision.

## References

- Albrecht, B.A., and C.H. Benson. 2001. Effect of desiccation on compacted natural clays. *In J. of Geotechnical and Geoenvironmental Engineering*. pp. 67–75.
- Barrington, S.F., P.J. Jutras, and R.S. Broughton. 1987a. The sealing of soils by manure: I. Preliminary investigations. *Canadian Agric. Eng.* 29(2):99–103.
- Barrington, S.F., P.J. Jutras, and R.S. Broughton. 1987b. The sealing of soils by manure: II. Sealing mechanisms. *Canadian Agric. Eng.* 29(2):105–108.
- Benson, C.H., and G.P. Boutwell. 2000. Compaction conditions and scale-dependent hydraulic conductivity of compacted clay liners. *In Constructing and Controlling Compaction of Earth Fills*. ASTM STP 1384, D.W. Shanklin, K.R. Rademacher and J.R. Talbot, eds. American Society for Testing and Materials, West Conshohocken, PA.
- Benson, C.H., and M. Othman. 1993. Hydraulic conductivity of compacted clay frozen and thawed *in situ*. *In J. of Geotechnical Engineering*, Amer. Soc. of Civil Eng. Vol 119, No. 2. pp. 276–294.
- Boutwell, G., and C.L. Rauser. 1990. Clay liner construction. Amer. Soc. of Civil Eng./Penn DOT Geotechnical Seminar. Hershey, PA.

- Daniel, D.E. 1993. Compacted clay liners and covers for arid sites. *In J. of Geotechnical Engineering*, Amer. Soc. of Civil Eng., Vol. 119, No. 2. pp. 223–237.
- Daniel, D.E., and C.H. Benson. 1990. Water content-density criteria for compacted soil liners. *In Journal of Geotechnical Engineering*, Amer. Soc. of Civil Eng., Vol. 116, No. 12. pp. 1811–1830.
- Daniel, D.E., and Yung-Kwang Wu. 1993. Compacted clay liners and covers for arid sites. *In J. of Geotechnical Engineering*, Amer. Soc. of Civil Eng., Vol. 119, No. 2, pp. 223–237.
- Ham, J.M., and T.M. Desutter. 1998. Seepage losses from swine-waste lagoons: a water balance of study. *Evaluation of Lagoons Containment of animal waste*. Kansas State University. Manhattan, KS. 3.2–3.19
- Hermann, J.G., and B.R. Elsbury. 1987. Influential factors in soil liner construction for waste disposal facilities. *Proc. Geotechnical Practice for Waste Disposal*. Amer. Soc. of Civil Eng., Ann Arbor, MI. pp. 522–536.
- Kansas State University. 2000. Animal waste lagoon water quality study. Ham, J.M., L.N. Redd, and C.W. Rice. Manhattan, KS.
- Kim, W., and D. Daniel. 1992. Effects of freezing on hydraulic conductivity of compacted clay. *In J. Geotechnical Engineering*, Amer. Soc. of Civil Eng., Vol. 118, No. 7.
- Kleppe, J.H., and R.E. Olson. 1985. Desiccation cracking of soil barriers. *ASTM Special Technical Publication 874, Hydraulic Barriers in Soil*. Philadelphia, PA. pp. 263–275.
- Lambe, T.W. 1958. The structure of compacted clay. *In J. of the Soil Mechanics and Foundation Division*, Amer. Soc. of Civil Eng., Vol. 84, No. Soil Mechanics 5, pp. 1654–1 to 1654–34.
- Mitchell, J.K., D.R. Hooper, and R.G. Campanella. 1965. Permeability of compacted clay. *J. Soil Mechanics and Foundation Div.*, Amer. Soc. of Civil Eng.. Vol. 91, No. 4. pp. 41–65.
- Oakley, R. 1987. Design and performance of earth-lined containment systems. *Amer. Soc. of Civil Eng. Conf. Geotech. Prac. Waste Disposal*, p. 117–136.
- U.S. Department of Agriculture, Natural Resources Conservation Service. 1994. Guide for determining the gradation of sand and gravel filters. *National Engineering Handbook*, Part 633, Chapter 26.
- U.S. Department of Agriculture, Soil Conservation Service. 1970. TR–28 Clay Minerals.

# Appendix 10E

## Synthetic Liner Guidelines



## Synthetic liners

Although compacted clay liners are the most common type of liners for manure impoundment structures, a storage pond or lagoon may require a synthetic liner for the following reasons:

- locating an acceptable clay material is not possible
- transporting an acceptable clay is too expensive
- using soil additives such as bentonite for sandy soils or a dispersant for higher permeability clays is too expensive
- using a reasonably thick compacted clay liner will not provide required seepage control
- using a synthetic liner is required by local regulations

## Synthetic liner materials

NRCS Conservation Practice Standard 521A, Pond Sealing or Lining—Flexible Membrane, provides the minimum criteria for pond liners constructed of synthetic materials. The standard describes the acceptable liner types and the minimum recommended thickness of each type of material. The standard covers two types of liners: geomembranes and geosynthetic clay liners (GCL). A GCL consist of bentonite embedded between two geosynthetic materials. Geomembranes are plastic or rubber liners. These NRCS criteria are shown in table 10E-1.

## Material selection

Selection of a geosynthetic liner material should consider several factors. In most cases, any of the liner materials included in the NRCS practice standard could perform adequately, but some may be preferred over others or be more economical. Factors to consider, although not comprehensive, are:

- pond size
- material flexibility
- ease of installation and quality control

- site geology
- site ground water conditions
- use of cover soil
- availability of experienced installers
- temperature during construction
- regulations
- costs

Material flexibility and ease of installation and quality control are independent of the site characteristics and location. Availability of experienced installers and regulations are independent of the specific site characteristics, but are location dependent.

Materials such as PVC, EPDM, PP, and RPP can be delivered to the site in panels of a fourth acre to greater in size. Pond liners of less than a half acre can often be installed with one field seam.

The flexibility of the material allows larger panels to be delivered to the site. Flexible materials such as PVC, EPDM, PP, RPP, and GCL are much easier to work with and install in an anchor trench and around corners. The more flexible materials may also conform to small undulations in the subgrade and reduce stress concentration in these areas.

**Table 10E-1** NRCS minimum criteria for liners

Type	Thickness	Type
HDPE	40 mil	Geomembrane
LLDPE	40 mil	Geomembrane
PVC	30 mil	Geomembrane
GCL	0.75 lb/ft (bentonite)	Geosynthetic clay liner
EPDM	45 mil	Geomembrane
PP	40 mil	Geomembrane
RPP	36 mil	Geomembrane

1 mil = 1/1000 of an inch  
 HDPE =High density polyethylene  
 LLDPE =Linear low density polyethylene  
 PVC =Polyvinyl chloride  
 GCL =Geosynthetic clay liner  
 EPDM =Synthetic rubber  
 PP =Polypropylene  
 RPP =Reinforced polypropylene

Due to the relatively small size of most NRCS waste pond applications, large installers may not be interested in NRCS projects. The ease of installation, seaming, and quality control of a material may allow installation by a less experienced installer or even farm labor under the direction of one experienced installer. Patching and repair of some liners, such as EPDM and GCL, are often completed by the land owner.

Locating an animal waste pond in areas of known sinkholes is not recommended. Consider having the site checked by using ground penetrating radar to identify any potential sinkhole areas. If sinkholes or karst terrain exist in an area, a geomembrane liner with sufficient strength and elongation properties is recommended to withstand some foundation movement. Reinforced geomembranes provide significantly more strength than unreinforced geomembranes. The use of heated seams rather than chemical or adhesive seams is also recommended.

The presence of ground water near the base of the liner can uplift the liner and cause significant damage. The use of cover soil provides some resistance to uplift from a high ground water table. A collection and drainage system may also be considered to dewater the foundation and soils surrounding the liner.

Cover soil is required to be placed on PVC liners and GCLs. Current PVC liners are susceptible to UV degradation and must be covered, while GCLs require a normal load on the liner to develop its low permeability once it is hydrated. Cover soil must be free of sharp or large particles, 3/8-inch for geomembranes and a half inch for GCLs. When cover soil is placed on the side slopes of ponds, a slope of 3H to 1V or flatter is typically recommended to maintain the soil on the slope without sliding down the slope on top of the liner. The friction between the cover soil and the liner may also be tested and evaluated to determine a stable side slope.

Installers in a geographic area may be more experienced with one material than another. In the recent years, experienced installers have traveled to rural and remote areas to install liners. The installation often takes 1 to 2 days once the subgrade is prepared.

Most geomembrane materials are stiffer in cooler temperatures. Less flexible materials, such as HDPE, are very difficult to handle in cold temperatures. Seaming

of all geomembranes is restricted during extremely high temperatures.

State regulations may require a particular type of liner material. If such State regulations exist, the required liner material should be used or equivalent substitute proposed to the regulatory agency.

Cost of the materials is always a consideration. All factors being equal, the liner materials have relatively similar total cost, including materials and installation. Liners that are covered will have the added cost of placing the cover material.

## Synthetic liner installation

Installation of the liner is often the most critical point in the life of the liner. Installation involves subgrade preparation, proper handling and storage, placement, seaming, completion of the anchor trench, and placement of cover soil, if required.

Subgrade preparation should include excavation or earthfill to the proper grade, removing any large and sharp objects, removing particles greater than 3/8-inch for geomembranes and a half inch for GCLs, removing soft material to provide a uniformly compacted base, and smoothing the surface with a rubber tired or steel wheel roller, if necessary. Geotextile padding, as shown in figure 10E-1, or soil padding and drains, if required, should be placed before the liner.

**Figure 10E-1** Geotextile padding





Prior to placement of the liner, the proposed material should be compared to the specifications. A certificate from the liner manufacturer is typically provided which details the properties of the proposed liner. Labels should be on each roll or panel identifying the manufacturer and material product name.

The liner material should be shipped, handled, and stored in a manner to prevent damage. The liner material should be protected from puncture, dirt, grease, excessive heat, or other damage. GCLs should be protected from moisture to prevent premature hydration. Rolls should be stored on a smooth surface (not

wooden pallets) and stacked no more than two to three rolls high, as shown in figure 10E-2. Panels of material should be shipped and stored on a pallet, as shown in figure 10E-3, and should not be stacked unless contained within a crate.

Rolls of material should be unloaded with a spreader bar or other method that provides support to the full length of the roll. Figures 10E-4 and 10E-5 show simple methods of providing this support. A spreader bar with lift cables is often used in place of the equipment bucket.

**Figure 10E-2** Stacked rolls



**Figure 10E-4** Unloading a roll



**Figure 10E-3** PVC Panel prepared for shipment



**Figure 10E-5** Unloading a roll with steel pipe through core





The liner should be placed to minimize slack and folds, but loose enough to allow thermal contraction. It should then be positioned to achieve the proper overlap for seaming. The liner should be positioned with the seams up and down the slope, as shown in figure 10E-6, rather than across the slope. Rolls are positioned using the “stationary pull,” as shown in figure 10E-7 or the “moving roll pull,” as shown in figure 10E-8. Liners delivered in large panels must be unfolded as shown in figure 10E-9 and “floated” into place by one person every 10 to 15 feet along the perimeter of the liner. The liner is floated into place on a pillow of air as shown in figure 10E-10. The liner should extend beyond the top of the slope to provide enough material for a proper anchor trench as shown in figure 10E-11. Following proper positioning of the liner, sand bags are recommended to ballast the liner against movement and uplift due to wind.

Proper seaming includes cleaning the area to be seamed, conducting the seaming with the proper method and according to the manufacturer’s recommendations, inspection, and testing of all the seams. Seaming methods and seam testing are described in more detail in the following sections.

An anchor trench is constructed around the perimeter of the pond to prevent the liner from sliding down the slope, prevent surface runoff from getting beneath the

**Figure 10E-7** Stationary pull



**Figure 10E-6** Seams up and down the slope



**Figure 10E-8** Moving roll pull



liner, and reduce uplift and wind damage. The trench is typically 18 to 24 inches deep, 12 to 24 inches in width, and located 3 feet from the top of the slope, as shown in figure 10E-12. The anchor trench backfill must not damage the liner. The backfill for the anchor trench must have the same particle size limit as the

subgrade. To reduce stress on the liner, the trench should be backfilled during the cooler part of the day. The liner should extend down the side and across the bottom of the anchor trench. The corners of the anchor trench should be rounded, rather than squared, to reduce concentration of stresses at the corner.

**Figure 10E-9** Unfolding large panels



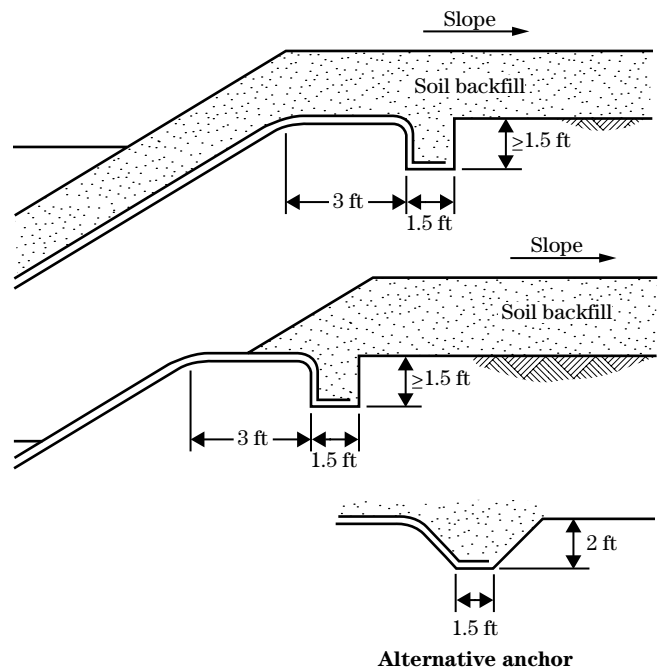
**Figure 10E-11** Liner extending into anchor trench



**Figure 10E-10** Floating liner into place



**Figure 10E-12** Anchor trench details (Source: Poly-Flex, Inc., 1995)



## Seaming methods

Geomembranes are seamed using several methods. Table 10E-2 identifies the available seaming methods for the various liner materials.

The primary method of seaming HDPE, LLDPE, RPP, and PP liners should be dual track hot wedge welds. Extrusion welds are recommended for repairs, T-seams, appurtenances and other details. Hot air fusion or solvent (also known as chemical fusion) welds may also be used on RPP or PP liners. A contact adhesive is not recommended for HDPE, LLDPE, RPP, or PP liners.

PVC liners may be seamed by hot air fusion, solvent (chemical), or by an adhesive. Dual track hot air fusion welds are recommended when possible for PVC liners.

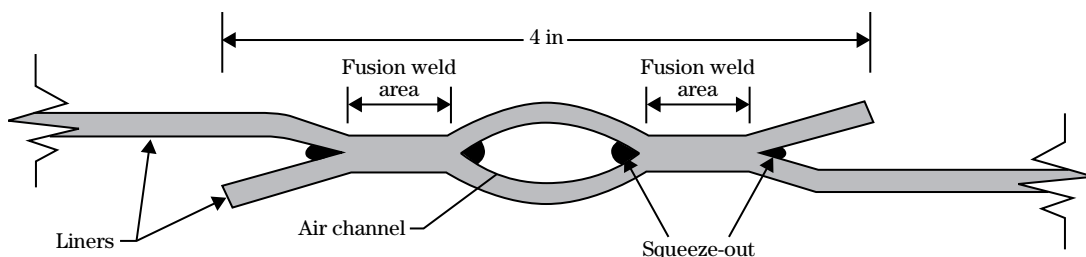
EPDM seams are considered adhesive seams and may consist of a 3-inch inseam tape or a 5- to 6-inch cover strip. The materials for the cover strip are more expensive than the inseam tape but provide a better seam with less time, skill, and effort. The cover strip is often preferred by liner installers.

A dual track hot wedge weld creates two seams with an air channel in between them, as shown in figures 10E-13 and 10E-14. The seaming process melts the surface of the adjoining areas of the liner and fuses them together with dual rollers. The air channel can be pressurized to allow seam integrity tests. Calibrated equipment and an experienced welder are required to weld a good seam. The temperature and speed of seaming must be balanced to create a good weld. This is the most common seaming method for HDPE, LLDPE, and PP.

**Table 10E-2** Geombrane seaming methods

Material	Extrusion	Hot air	Hot wedge	Solvent	Contact adhesive
PVC		X		X	X
PP or RPP	X	X	X		X (not recommended)
HDPE	X	X	X		X (not recommended)
LLDPE	X	X	X		X (not recommended)
EPDM					X

**Figure 10E-13** Dual track hot wedge or air weld



Extrusion welding is similar to welding steel. The liner is heated by hot air and a ribbon of molten polymer (same polymer as the liner) is extruded to the edges of the adjacent panels, patches, or seams as shown in figure 10E-15. Extrusion welding is essentially the only method to seam HDPE and LLDPE patches for repairs, pipe boots, and other details. The surface of the area to be welded should be ground, as shown in figure 10E-16, no more than 15 minutes prior to welding and no more than 10 percent of the thickness of the liner shall be ground.

Hot air welding may be a single or dual track hot air weld. The dual track hot air weld creates two seams with an air channel in between them just as the dual track hot wedge weld. Calibrated equipment and an

experienced welder are required to weld a good seam. The temperature and speed of seaming must be balanced to create a good weld. Hot air welders are available in hand held or automated models. Since it is very difficult to control the temperature of the liner with the hand held models, automated welders are recommended. The dual track hot air weld is becoming the most common seaming method for PVC and is often used to weld PP and RPP.

Solvents (chemically welded seams) are created by use of a liquid solvent which “melts” the surface of the geomembrane material followed by applying pressure with a roller. Once the solvent dissipates, the weld is fused.

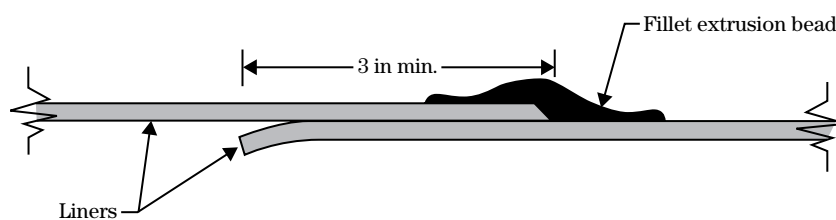
**Figure 10E-14** Dual track hot wedge welder (Source: Poly-Flex, Inc., 1995)



**Figure 10E-16** Grinding for an extrusion weld



**Figure 10E-15** Extrusion weld



Adhesive seams are created by applying the adhesive between the overlap of adjacent panels with a brush or other approved method. Pressure is then applied to the seam to provide adequate contact between the panels. This type of seam is used primarily on EPDM liners with some use on PVC and PP.

The rate at which geomembrane seaming may be accomplished is presented in table 10E-3. PVC, PP, and EPDM liners require one to two seams on a typical animal waste pond. HDPE/LLDPE requires a seam every 20 to 25 feet. Fortunately, the seaming rate for hot wedge and extrusion welds is relatively fast.

**Table 10E-3** Geomembrane seaming rates

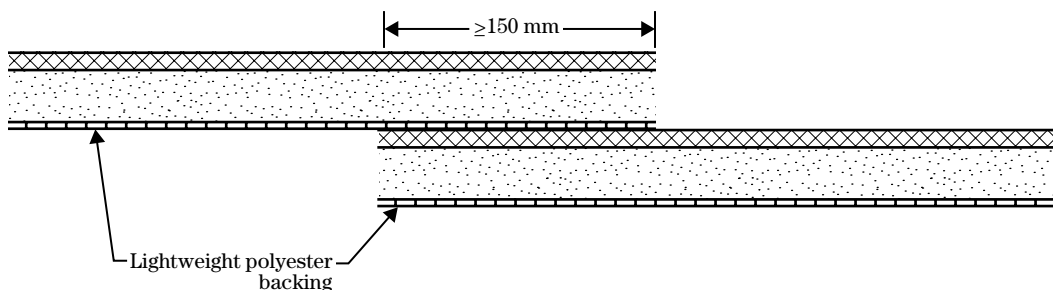
Method	Typical rate
Extrusion	100 ft/h
Hot air	50 ft/h
Hot wedge	300 ft/h
Solvent (chemical)	300+ ft/h
Adhesive	400+ ft/h

GCL seams are constructed with a 6-inch overlap, as shown in figure 10E-17. Seams typically require a quarter pound of powder bentonite per foot of seam. Some manufacturers have developed products that have the bentonite exposed near the edge. Additional bentonite at the seam is not required on these products. The critical aspect of GCL seaming is to have sufficient cover soil over the seam prior to hydration of the bentonite. If the bentonite at the seam hydrates without a load, it will not develop the low permeability required for an adequate seam.

### Seam testing

Seams may be nondestructively field tested by various methods. Standard methods are available for air channel test (ASTM D 5820), air lance test (ASTM D 4437), or a vacuum box test (ASTM D 5641). Double-track hot wedge and hot air seams are typically tested by an air channel test. Vacuum box tests are performed on all extrusion welds and may be used on PP chemical fusion welds. Due to the flexibility of PVC, vacuum box tests often give false indications of a good seam. Air lance tests are performed on single-track fusion welds, chemical fusion welds, and adhesive PVC seams and EPDM seams. Air lance tests may also be used on PP chemical fusion seams.

**Figure 10E-17** Typical GCL seam





The air channel test is conducted in accordance with ASTM D 5820 and illustrated in figure 10E-18. The test pressure varies based on the material type and thickness. The typical test pressures for 40 mil HDPE, LLDPE, and PP; 30 mil PVC; and 40 mil PVC are 25 to 30 pounds per square inch, 15 to 25 pounds per square inch, and 20 to 30 pounds per square inch, respectively. The associated allowable pressure drops over a 5-minute period are 4 pounds per square inch, 5 pounds per square inch, and 4 pounds per square inch, respectively.

An air lance test is conducted in accordance with ASTM D 4437 and illustrated in figure 10E-19. The test includes applying air pressure of 50 pounds per square inch through a 3/16-inch nozzle along the entire length of the seam. The nozzle is maintained no more than 2 inches from the seam. Defects in the seam will flutter under pressure, and small defects will whistle as the pressurized air passes through the defect.

A vacuum box test is used to test extrusion welded seams and is conducted in accordance with ASTM D 5641 and illustrated in figure 10E-20. The seam to be tested is covered with soap and water and the vacuum box is placed over the area to be tested. A vacuum of 4 to 8 pounds per square inch is applied to the box and the area being tested is observed for bubbles which will appear to unbonded areas.

**Figure 10E-18** Air channel test

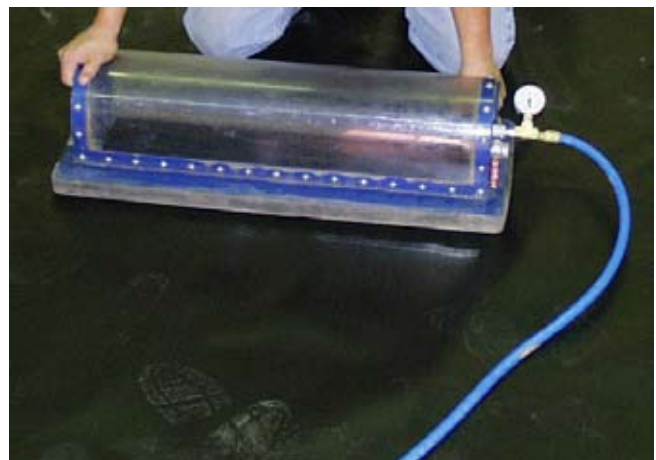


Destructive seam testing is often not required on the seams of animal waste storage pond liners. Destructive seam testing is recommended on trial seams to be conducted once or twice daily. A trial seam and test involves welding a seam that is not part of the actual

**Figure 10E-19** Air lance test



**Figure 10E-20** Vacuum box test



pond liner, cutting specimens with a device similar to that shown in figure 10E-21, and testing the specimen in both peel and shear using a field tensiometer, as shown in figure 10E-22.

## Appurtenances

Appurtenances for animal waste pond synthetic liners include pipe penetrations, attachment to structures, vents, and liner protection. Appurtenances should always be designed to prevent damage to the liner during installation or operation.

Pipe penetrations may be a pipe boot, concrete collar/pad, or bentonite (for GCLs). A pipe boot should be fabricated from the same material as the liner and fastened to the pipe and liner in a manner to prevent leakage, such as shown in figure 10E-23. Fastening to the pipe includes a neoprene gasket and metal bands or clamps to secure the boot to the pipe. Use of stainless steel bands/clamps is recommended. A sealant applied at the downstream edge of the boot to pipe connection is also recommended.

Concrete collars are often used for large pipe penetrations where a pipe boot is not practical. Use of a sealant between the pipe and concrete collar is recommended.

A pipe penetration through a GCL included excavation of a 3- to 4-inch-deep notch around the penetration, which is filled with powder or granular bentonite. This is overlain by a GCL with a hole for the pipe with a quarter pound of bentonite per square foot of area between the GCL liner and GCL collar, as shown in figure 10E-24.

The common methods of attachment to structures include mechanical attachments, embed channel, or adhesives.

Mechanical attachments to concrete structures should consist of concrete anchor bolts, neoprene gaskets, flat metal bar (batten strip), washers, and nuts. All metal components should be stainless steel or aluminum. A typical detail is shown in figure 10E-25.

An embed channel is a channel-shaped section of the same material as the liner that is embedded in the concrete while the concrete is still wet. Adjacent channels should be extrusion welded to prevent gaps between the channel sections. The geomembrane is welded to the embed channel with a continuous extrusion weld as shown in figure 10E-26. Embed channels are available for HDPE, LLDPE, and PP.

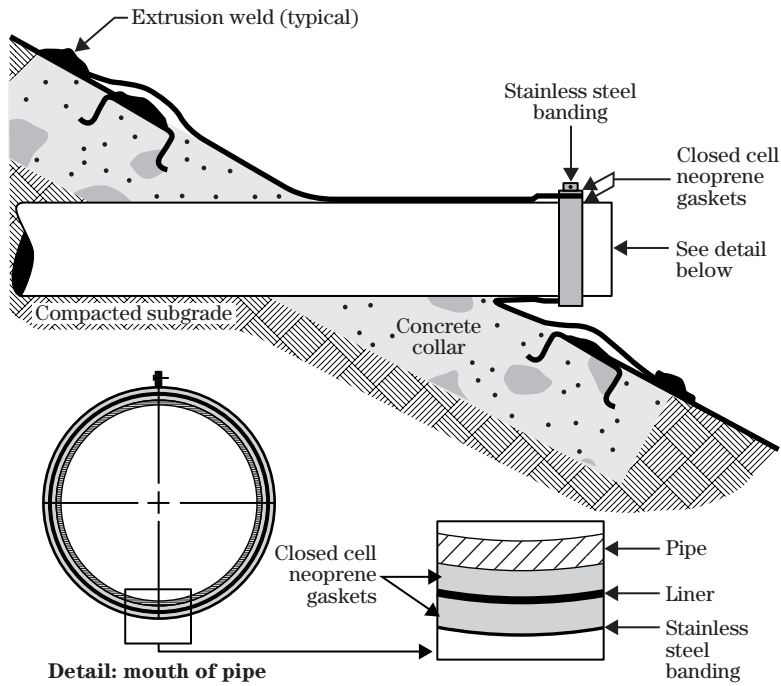
**Figure 10E-21** Test specimen cutter



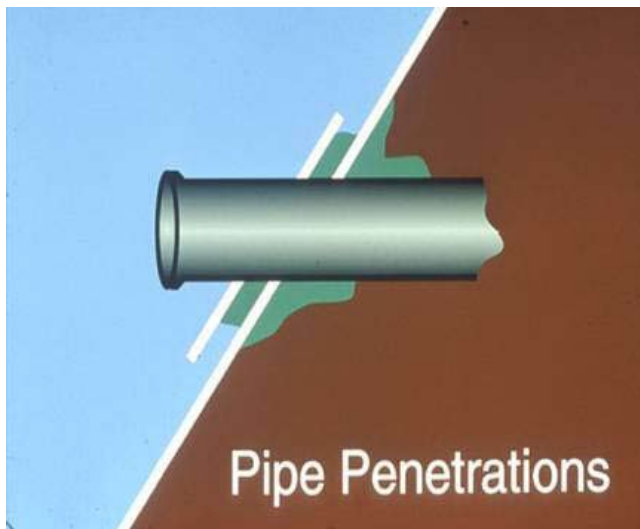
**Figure 10E-22** Field tensiometer (Source: Poly-Flex, Inc., 1995)



**Figure 10E-23** Pipe boot (Source: CETCO)

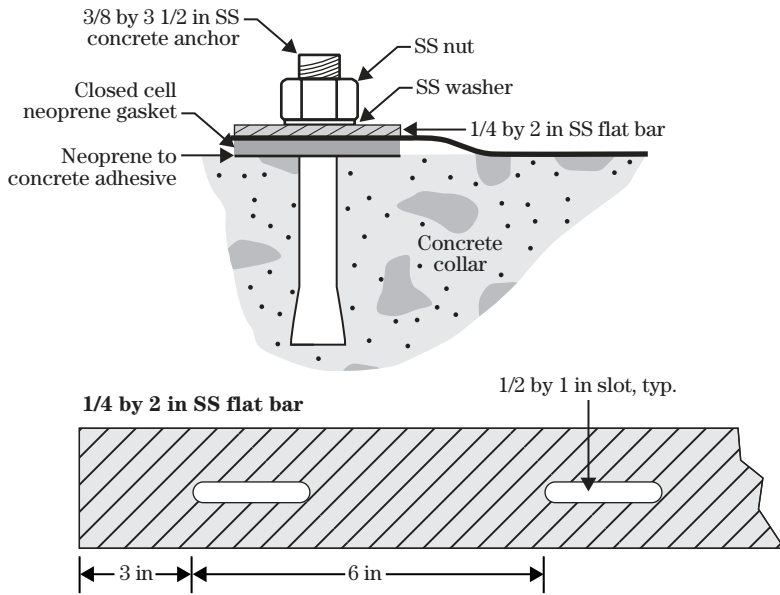


**Figure 10E-24** GCL pipe penetration (Source: Poly-Flex, Inc.)

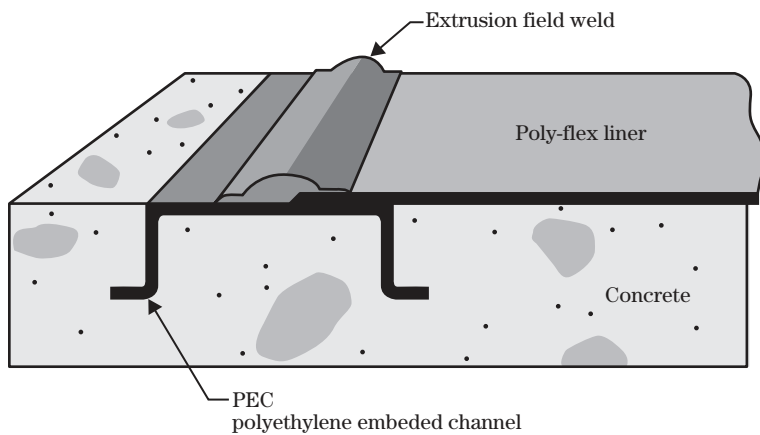




**Figure 10E-25** Typical mechanical attachment (Source: Poly-flex, Inc.)



**Figure 10E-26** Embed channel

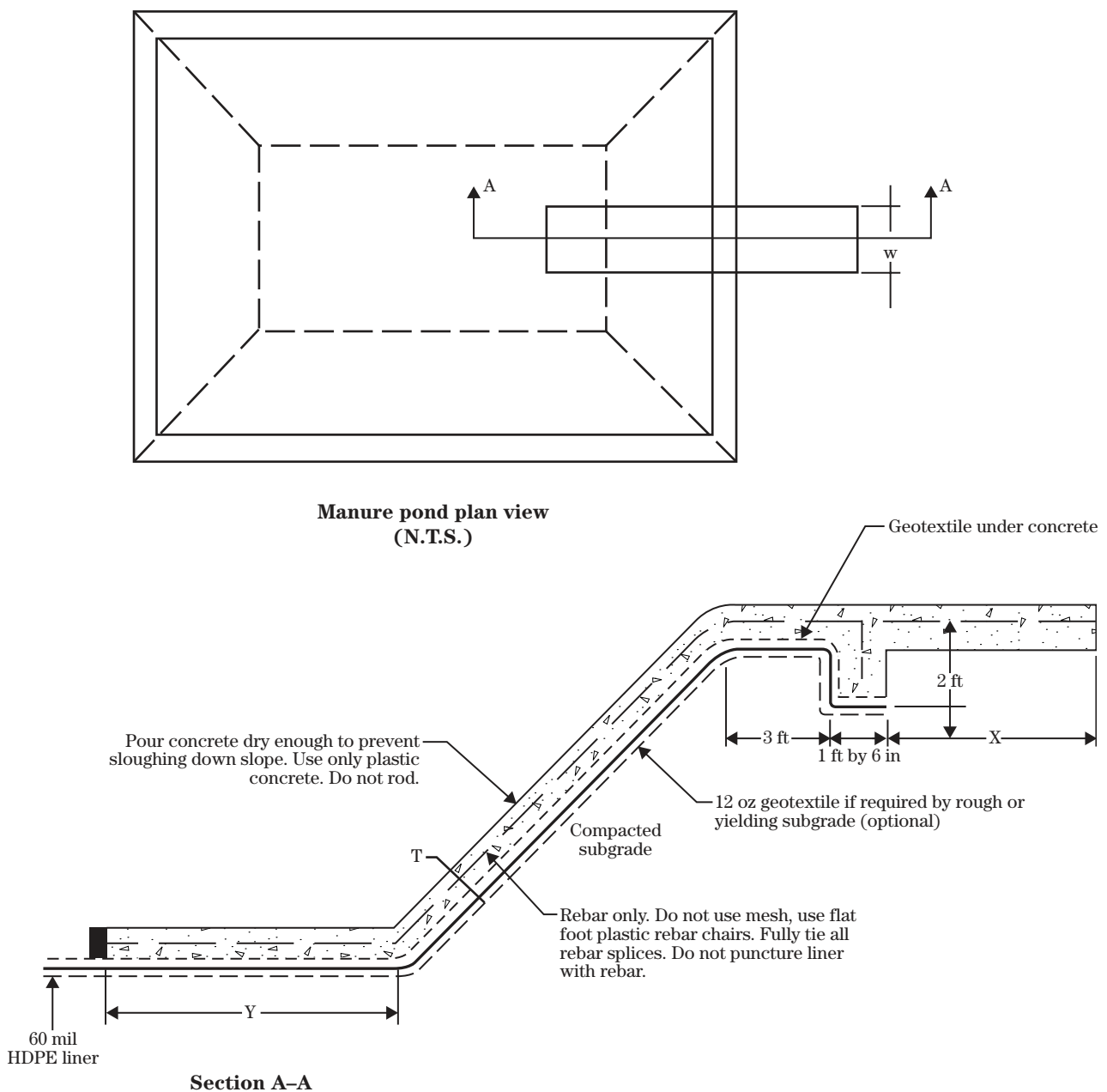


Liner protection from maintenance equipment such as agitators and pumps is often provided by concrete ramps, a geotextile pad, or an additional liner. A detail of a concrete ramp is shown in figure 10E-27.

Gas may build up beneath a liner due to a rising water table, organic soil or waste beneath the liner, or

leaks within the liner. Where this is a concern, liner vents should be considered. Vents should be installed above the normal water line to prevent waste from entering the vent. Vents are typically spaced 30 to 50 feet around the entire perimeter of the liner. Covered and uncovered vents are shown in figures 10E-28 and 10E-29.

**Figure 10E-27** Concrete ramp



**Figure 10E-28** Uncovered liner vent

Any observed damage should be repaired immediately. Burrowing rodents that could damage the liner should be removed from the area.

Any vents should be clear and the flaps free to release any gases beneath the liner. Vent covers that are missing or damaged should be replaced. Operation of the pond should insure that the waste level never rises to an elevation that would allow waste to enter the vents.

All failed seams should be repaired by installing a cap strip over the entire length of the failed seam. Cap strip should consist of the same material as the liner and extend beyond the failed seam a minimum of 6 inches. A repaired seam is shown in figure 10E-30. A failed seam on HDPE, LLDPE, or PP may be repaired by extrusion welding along the entire length of the seam. Small defects in EPDM liners may be repaired with a cover strip that extends a minimum of 4 inches beyond the damaged area. The cut edges of reinforced patches must be sealed with an extrudant to prevent wicking of waste through the reinforcement.

**Figure 10E-29** Covered liner vent

If a GCL is damaged, the area should be completely exposed and all soil removed from the top of the GCL. A GCL patch should extend a minimum of 12 inches beyond the damaged area. Granular bentonite should be placed between the patch and liner at a rate of 1 pound per 2 square feet of area covered to minimum width of 6 inches.

## Maintenance and repairs

Successful performance of animal waste pond liners requires some maintenance and often requires repair. The visible portions of the liner should be inspected for tears, punctures, or other damage. The interface of the liner with inlets, outlets, ramps, or other appurtenances should also be inspected. The level of the pond should be monitored to prevent overflow. Each time the pond is pumped down, a visual inspection of the entire liner is recommended. If the pond is agitated, special precautions should be taken in the area of the agitator. Ballooning of the liners indicates the presence of gas beneath the liner which is often the result of leaks.

**Figure 10E-30** Liner repair

## Example

A half acre (total bottom and sides area) AWSP is to be constructed at a site where the soils are classified as SP and SM with some gravel in accordance with the Unified Soil Classification System. The excavated soils will not be used as cover soil. The depth of the pond is 10 feet. The depth to the seasonal high ground water is 10 feet. The site is located in a rural area several hours from experienced installers and geomembrane welders. The landowner does not efficiently separate solids from the waste and applies the waste to adjacent fields twice a year.

Since the site soils consist of sandy materials, construction of a compacted clay liner would require importing clay materials. Geosynthetic liners that require cover soil such as PVC and GCL should not be considered first. Materials such as HDPE, LLDPE, and PP that require special welding procedures for seams should not be considered first.

Materials such as EPDM, PVC, and GCL are best suited for installation by less experienced installers. Due to the flexibility of EPDM, PP, RPP and PVC, the materials could be delivered in large panels requiring only one field seam. Since the excavated soils will not be used for cover soils, obtaining cover soil from another source would be an additional expense for PVC and a GCL. The EPDM and PP liners do not have to be covered and should be the first considered.

The NRCS Conservation Practice Standard 521A, Pond Sealing or Lining—Flexible Membrane, lists the minimum thickness of the acceptable geosynthetic liner materials. The NRCS practice standard minimum thickness for EPDM is 45 mil and for PP is 40 mil. A GCL is also allowed.

The site soils contain some gravel. Removal of particles over 3/8 inch and sharp particles is required to prevent damage of the liner. An alternative to removing all the gravel is to include a nonwoven geotextile or sand padding beneath the liner.

The seasonal water table is near the bottom of the pond. Design should consider constructing approximately 2 feet of the pond above the ground to raise the bottom of the pond above the water table. This will affect the design of the site considerably because a wider berm will be needed for equipment access and the anchor trench. A perimeter trench may also be an alternative to keep the water table from impacting the liner.

The rising water table may induce gas pressure beneath the liner. Since the site soils consist of sand, the addition of a geotextile to allow migration of gas to the sides is not necessary. Vents above the high water line along the perimeter of the pond should be installed.

The landowner does not separate solids and will pump liquid from the pond. Equipment access ramps and pads should be installed to allow access of an agitator and pumps. A fence around the pond is required by the practice standard. A safety ladder should be considered to allow escape upon accidental entry. A staff gage should be used to indicate when the pond should be emptied. Diversions should be designed to keep all possible surface water runoff out of the pond.