



Issued August 2007

Cover photo: Manufactured concrete blocks are available in a variety of thicknesses and configurations and can be used to stabilize the streambed or streambanks.

Advisory Note

Techniques and approaches contained in this handbook are not all-inclusive, nor universally applicable. Designing stream restorations requires appropriate training and experience, especially to identify conditions where various approaches, tools, and techniques are most applicable, as well as their limitations for design. Note also that product names are included only to show type and availability and do not constitute endorsement for their specific use.

Contents

Purpose	TS14L-1
Introduction	TS14L-1
Applications	TS14L-1
Materials	TS14L-6
Blocks.....	TS14L-6
Connections.....	TS14L-6
Geotextiles.....	TS14L-6
Granular filter.....	TS14L-6
Performance testing and evaluation.....	TS14L-9
Design procedure	TS14L-11
Factor of safety.....	TS14L-11
Blocks.....	TS14L-11
Filter.....	TS14L-11
Specifying ACB revetment systems	TS14L-14
Blocks.....	TS14L-14
Connections.....	TS14L-14
Geotextile.....	TS14L-14
Testing.....	TS14L-14
Design.....	TS14L-14
Installation	TS14L-14
Subgrade preparation.....	TS14L-14
Geotextile placement.....	TS14L-16
Placement of the ACB.....	TS14L-16
Termination.....	TS14L-16
Anchor penetrations.....	TS14L-16
Filling.....	TS14L-16
ACB example calculations	TS14L-19
Conclusion	TS14L-21

Tables			
Table TS14L-1	Steel cable specifications		TS14L-8
Table TS14L-2	Polyester cable specifications		TS14L-8
Table TS14L-3	Design equations for ACB revetment systems		TS14L-13
Table TS14L-4	Block physical requirements		TS14L-15
Table TS14L-5	NRCS specifications for woven geotextiles		TS14L-15
Table TS14L-6	NRCS specifications for nonwoven geotextiles		TS14L-15

Figures			
Figure TS14L-1	Armoring the entire cross section		TS14L-2
Figure TS14L-2	Armoring the toe and lower slope cross section		TS14L-2
Figure TS14L-3	Armoring the toe and slide slope cross section		TS14L-3
Figure TS14L-4	Streambed grade stabilization profile		TS14L-3
Figure TS14L-5	Armoring of pipe/culvert outlets profile		TS14L-4
Figure TS14L-6	Scour protection around bridge piers plan		TS14L-5
Figure TS14L-7	Examples of ACB blocks		TS14L-7
Figure TS14L-8	Steel cables		TS14L-8
Figure TS14L-9	Polyester cables		TS14L-8
Figure TS14L-10	ACB section with a geotextile filter and combination geotextile and granular filter		TS14L-8
Figure TS14L-11	ACBs in combination with granular and geotextile filter		TS14L-9
Figure TS14L-12	Schematic of a typical laboratory test flume for ACB performance testing		TS14L-9

Figure TS14L-13	Forces on an ACB revetment system during performance test	TS14L-10
Figure TS14L-14	Forces on a protruding block	TS14L-10
Figure TS14L-15	Block on a side slope with design variables	TS14L-12
Figure TS14L-16	Block moment arms	TS14L-12
Figure TS14L-17	Granular filter encapsulation by a geotextile	TS14L-17
Figure TS14L-18	Spreader bar for placement of cabled mats	TS14L-17
Figure TS14L-19	Hand placement of ACB blocks	TS14L-17
Figure TS14L-20	ACB termination trench	TS14L-18
Figure TS14L-21	Filling ACBs with top soil	TS14L-18
Figure TS14L-22	ACB revetment system 1 year after completion	TS14L-18
Figure TS14L-23	ACB revetment system 2 years after completion	TS14L-18

Purpose

A variety of natural and manufactured materials can provide erosion protection for stream restoration and stabilization projects. One of these products is the articulating concrete block (ACB) revetment system. An ACB revetment system is a matrix of interconnected concrete block units installed to provide an erosion resistant revetment with specific hydraulic characteristics. It is static protection and is applicable in high risk applications where no additional bank or grade movement is allowable. This technical supplement describes the ACBs currently available and some of the benefits of their use. The system consists of concrete blocks, a filter (typically a geotextile), and cables in some products. A summary of testing for hydraulic performance is presented along with a design procedure for open channel flow. Critical installation features are described for typical installations including subgrade preparation, ancillary components (such as drainage layers), filter placement, ACB placement, system termination, anchors, and penetrations.

Introduction

Stream restoration and stabilization may require the use of armoring countermeasures to provide lateral or vertical stability to a stream. Armoring countermeasures include concrete lining and other rigid revetments, rock riprap, gabion baskets, gabion mattresses, or ACB revetment systems. These countermeasures result in a statically stable stream within the armored area. Armoring countermeasures provide permanent erosion protection to underlying soil from the forces of flowing water. Armoring countermeasures may be used when vegetation and other soil bioengineering practices are not suitable or unstable under the stress or duration of the design event or where the consequences of failure are unacceptable. The designer should keep in mind that since its use results in a static section, other stability and ecological issues may become a concern. Typical applications of the ACB revetment system include entire channel cross-sectional protection, toe and lower side slope protection, and grade stabilization structures.

An ACB revetment system consists of a matrix of interconnected concrete block units sufficient for

erosion protection. The individual units are connected by geometric interlock, cables, ropes, geotextiles, geogrids, or a combination thereof and, typically, overlay a geotextile for subsoil retention (American Society for Testing and Materials (ASTM) D6684). The filter layer may consist of a geotextile, properly graded granular filter, or both. Proper design of the filter layer is critical to the successful performance of the ACB revetment system. The individual blocks of the system are able to conform to changes in the subgrade, while remaining connected due to the geometric interlock or other system components such as cables.

The intent of this section is to provide an introduction to the applications, materials, hydraulic testing, design, specification, and installation of ACB revetment systems for stream restoration and stabilization projects. This technical supplement does not address stream stability, hydraulic analyses of the stream flow, or geotechnical analyses and slope stability of the stream slopes. ACBs do not provide strength to a slope; therefore, a protected slope must be geotechnically stable prior to placement of the ACB revetment system.

Applications

ACB revetment systems have been used in a variety of applications for streambank stabilization and restoration projects (figs. TS14L-1 through TS14L-6). These applications include:

- armoring the entire cross section
- armoring the toe and lower slope
- armoring the toe and side slope
- streambed grade stabilization
- armoring of pipe/culvert outlets
- scour protection around bridge piers

Figure TS14L-1 Armoring the entire cross section

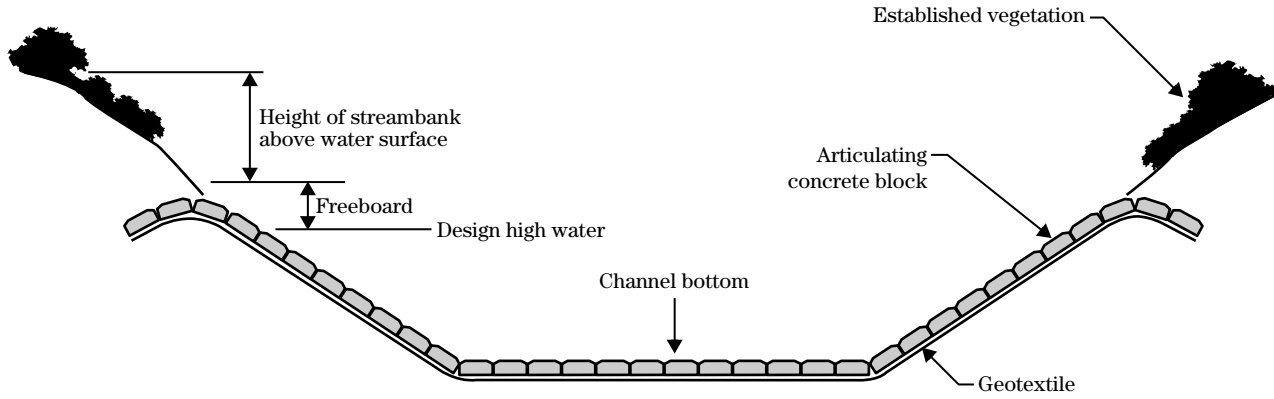
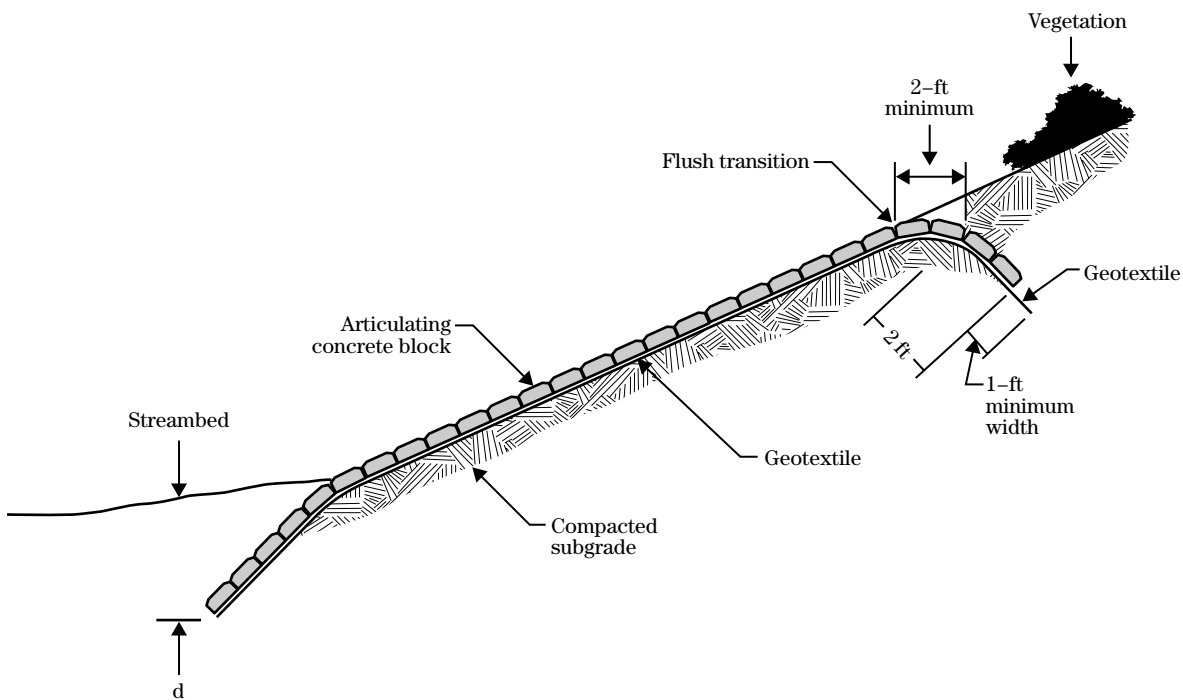

Figure TS14L-2 Armoring the toe and lower slope cross section



d = maximum depth of scour

Figure TS14L-3 Armoring the toe and slide slope cross section

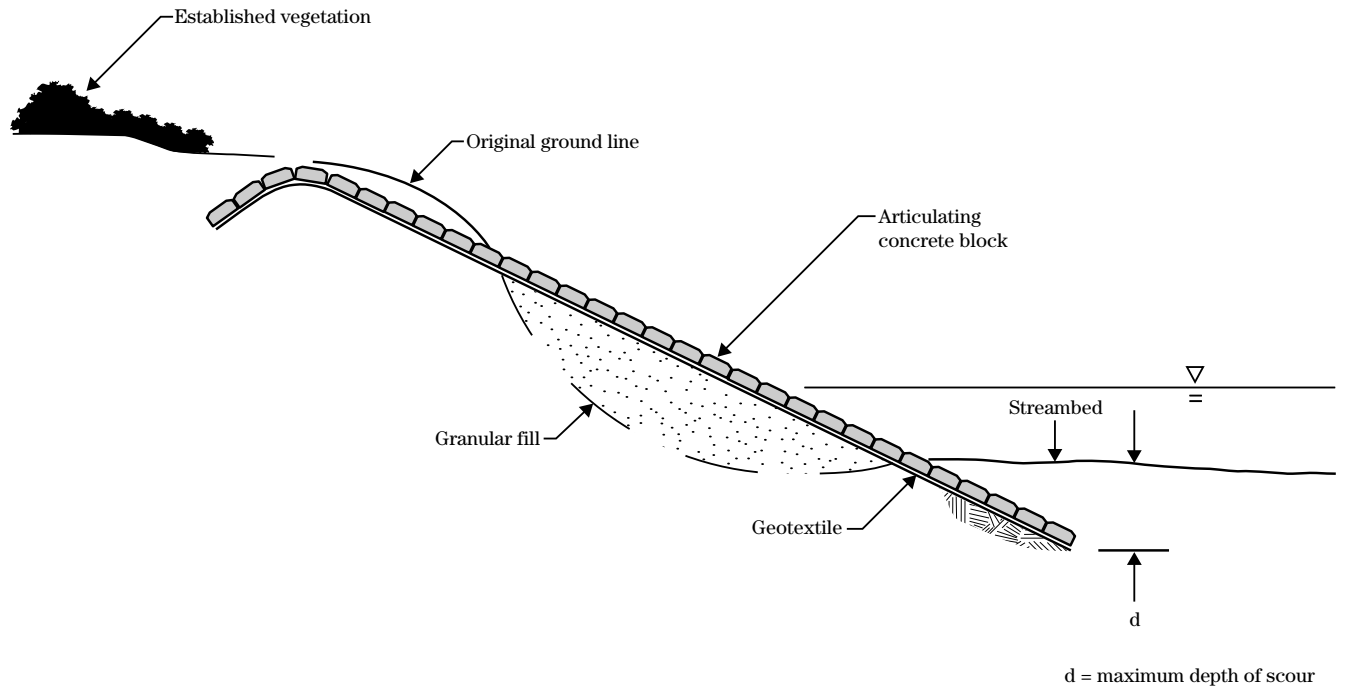

Figure TS14L-4 Streambed grade stabilization profile

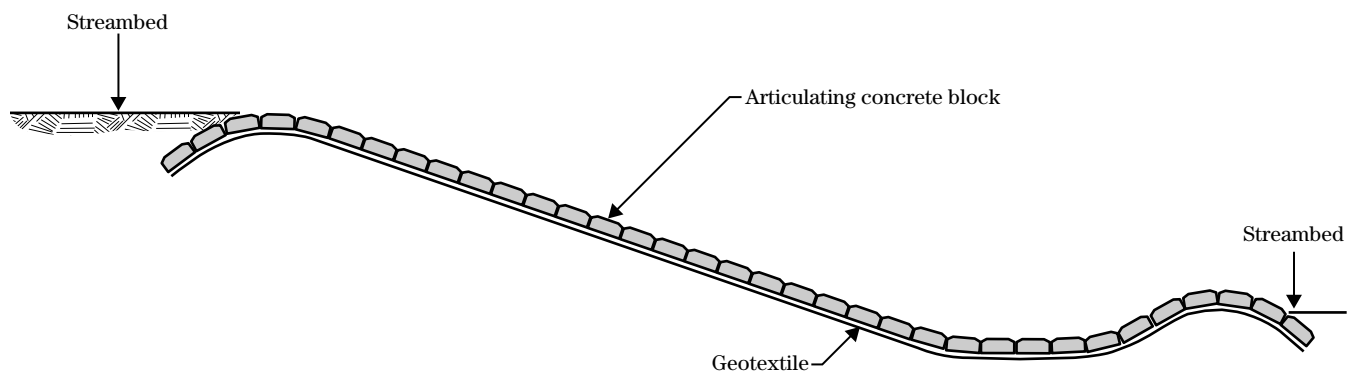

Figure TS14L-5 Armoring of pipe/culvert outlets profile

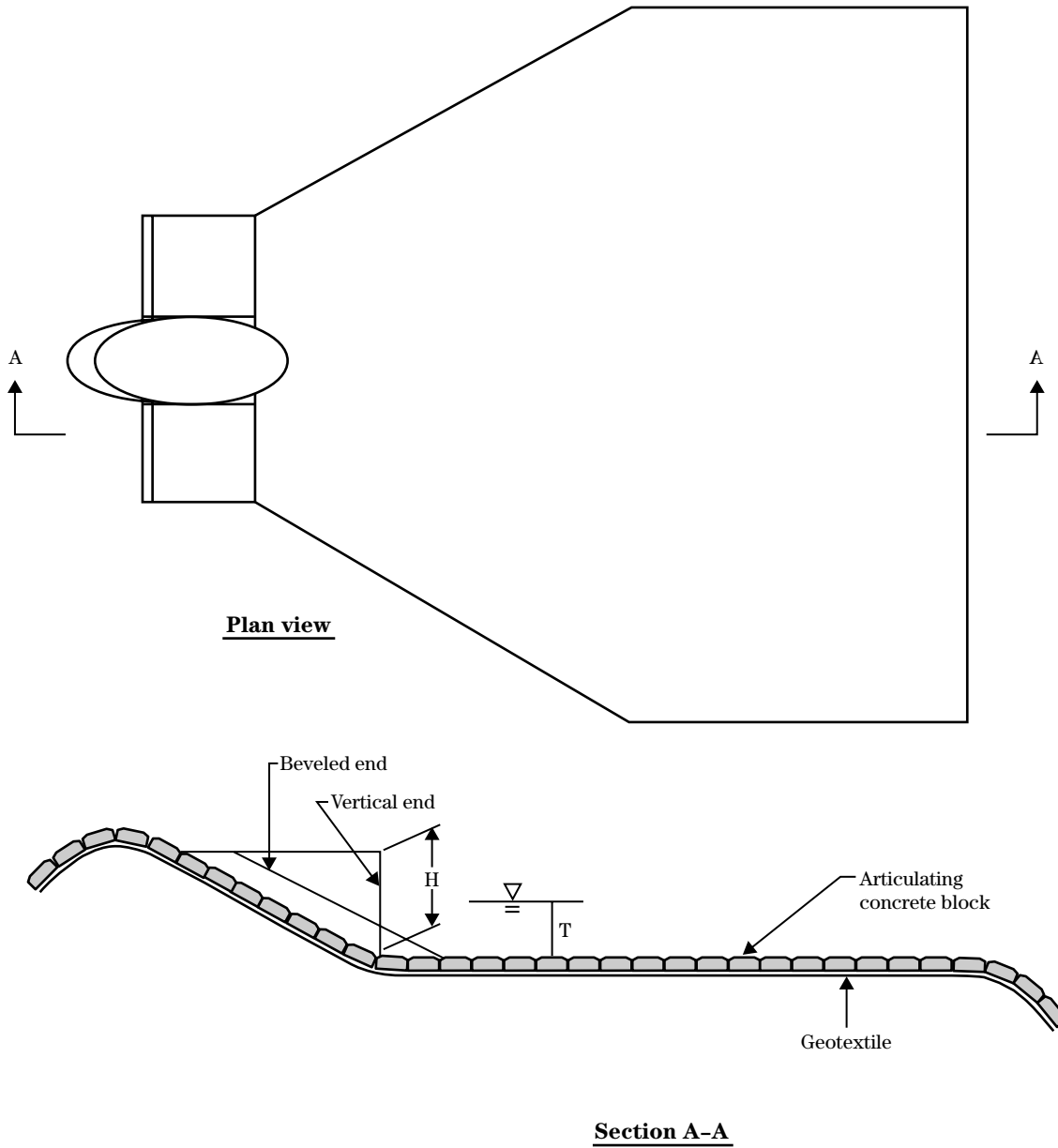
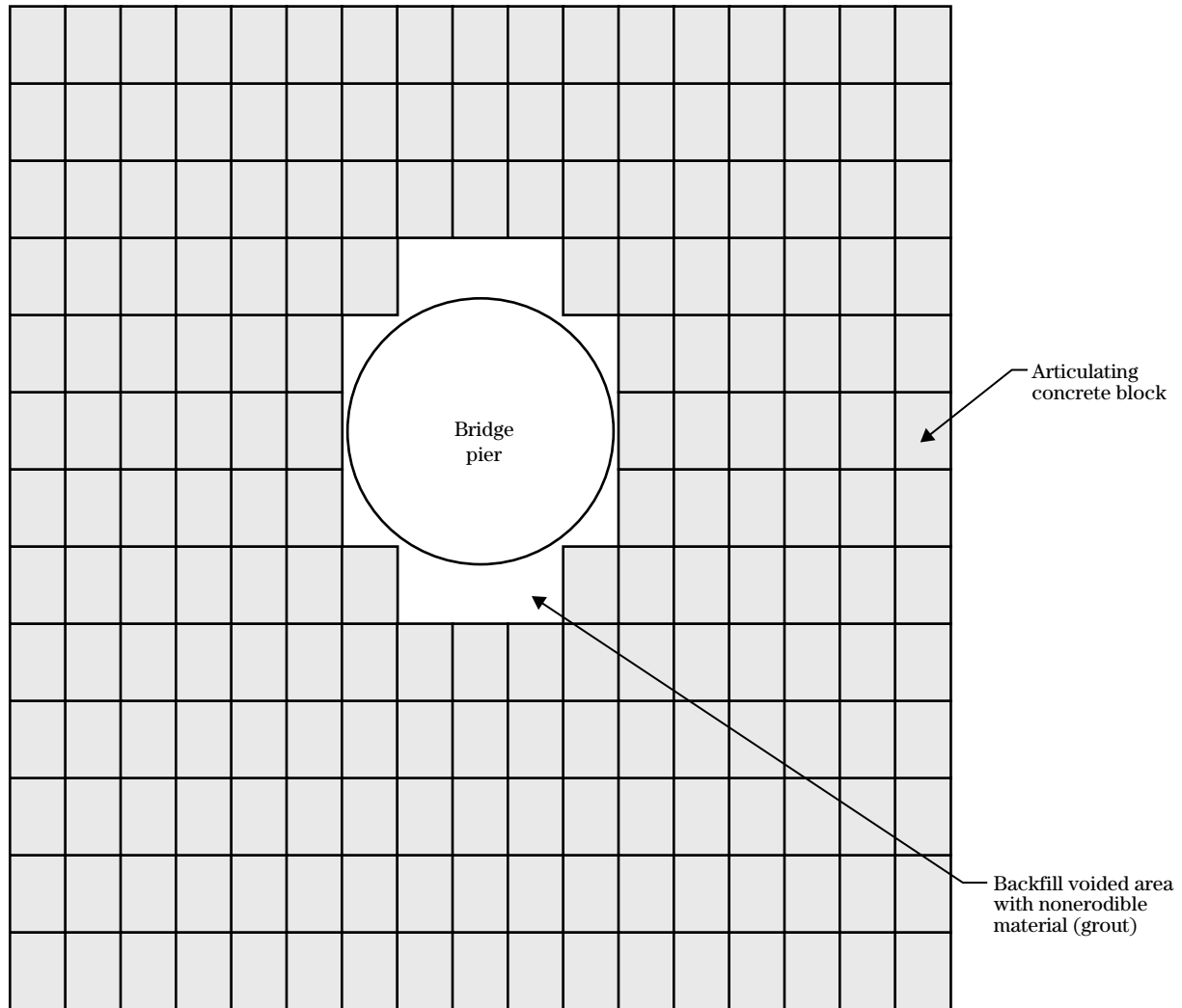

Figure TS14L-6 Scour protection around bridge pier plan



Plan view

Note:
Termination trench required
both upstream and downstream

Materials

Blocks

Several proprietary ACB revetment systems are available. The blocks can be made in a variety of shapes and thicknesses. The thickness of available blocks typically ranges from 4 inches to 9 inches. Tapered and wedge-shaped blocks are also available. Figure TS14L-7 shows some of the block shapes available for ACB revetment systems.

The blocks are made of precast concrete. The blocks are cast into interlocking or noninterlocking shapes. The blocks may be cabled into mats or can be non-cabled. Blocks to be cabled usually have preformed holes cast in them for placement of the cable, although some systems are manufactured with the blocks cast directly onto the cables. The holes should be smooth to prevent damage to the cable.

The blocks may be open cell or closed cell. Open-cell block systems provide an overall open area ranging from 17 to 23 percent for the system. The open area allows soil to be placed into them or for sediment to fill in the open areas and become vegetated.

Closed-cell block systems provide an open area of approximately 10 percent and allow for some trapped soil and vegetation growth. Although the cable concrete block developed by International Erosion Control Systems is a closed cell, the individual blocks can be spaced to provide an open area of greater than 20 percent.

Connections

Individual blocks that are connected into a mat are often referred to as cabled systems. The cable may consist of ropes, polyester revetment cable, or galvanized or stainless steel cable. An underlying geotextile or geogrid is sometimes used in lieu of cables, and the blocks are attached with adhesive. The individual blocks may be assembled into mats offsite or constructed onsite by hand placement.

The most widely used connections consist of polyester revetment cable and steel cable. Steel cable is typically

stainless steel aircraft cable of type 302, 304, or 316 (fig. TS14L-8). Typical steel cable specifications are shown in table TS14L-1.

Polyester cable is typically constructed of high tenacity, low elongating, and continuous filament polyester fibers (fig. TS14L-9). Cable consists of a core construction comprised of parallel fibers contained within an outer jacket or cover. The weight of the parallel core is between 65 percent to 70 percent of the total weight of the cable. Typical polyester cable specifications are shown in table TS14L-2.

Geotextiles

Geotextiles are typically used to retain the soil particles serving as the subgrade for the ACBs (fig. TS14L-10). Geotextiles may be woven or nonwoven and may be composed of multifilament yarns or monofilament yarns. Woven slit film (monofilament or multifilament) geotextiles should not be used as a filter beneath ACBs since the materials are weak, and the opening size and percent open area are unpredictable. Nonwoven geotextiles should be needle-punched and not be heat-bonded or resin-bonded, nonwoven geotextiles. The permeability of heat-bonded and resin-bonded nonwoven geotextiles is too low to allow adequate seepage and dissipation of hydrostatic pressure. Geotextiles are addressed in more detail in NEH654 TS14D. More detailed descriptions of geotextile materials may also be found in Harris County Flood Control District (HCFCD) 2001; American Association of State Highway Transportation Officials (AASHTO) 2000; and U.S. Army Corps of Engineers (USACE) (1995b).

Granular filter

The purpose of the granular filter is to intercept water flowing through the pores of the subgrade soil, allowing for the passage of the water, while retaining the subgrade soil particles. Granular filters consist of sand, gravel, or a sand and gravel mixture and may contain some fine-grained particles.

Fine sand or silt subgrade soils may require the use of a dual granular filter or a combination of a granular filter and a geotextile designed to retain the underlying granular soil. A combination of a granular filter and a geotextile are shown in figures TS14L-10 and TS14L-11.

Figure TS14L-7 Examples of ACB revetment systems (*Figures courtesy of HCFCD*)

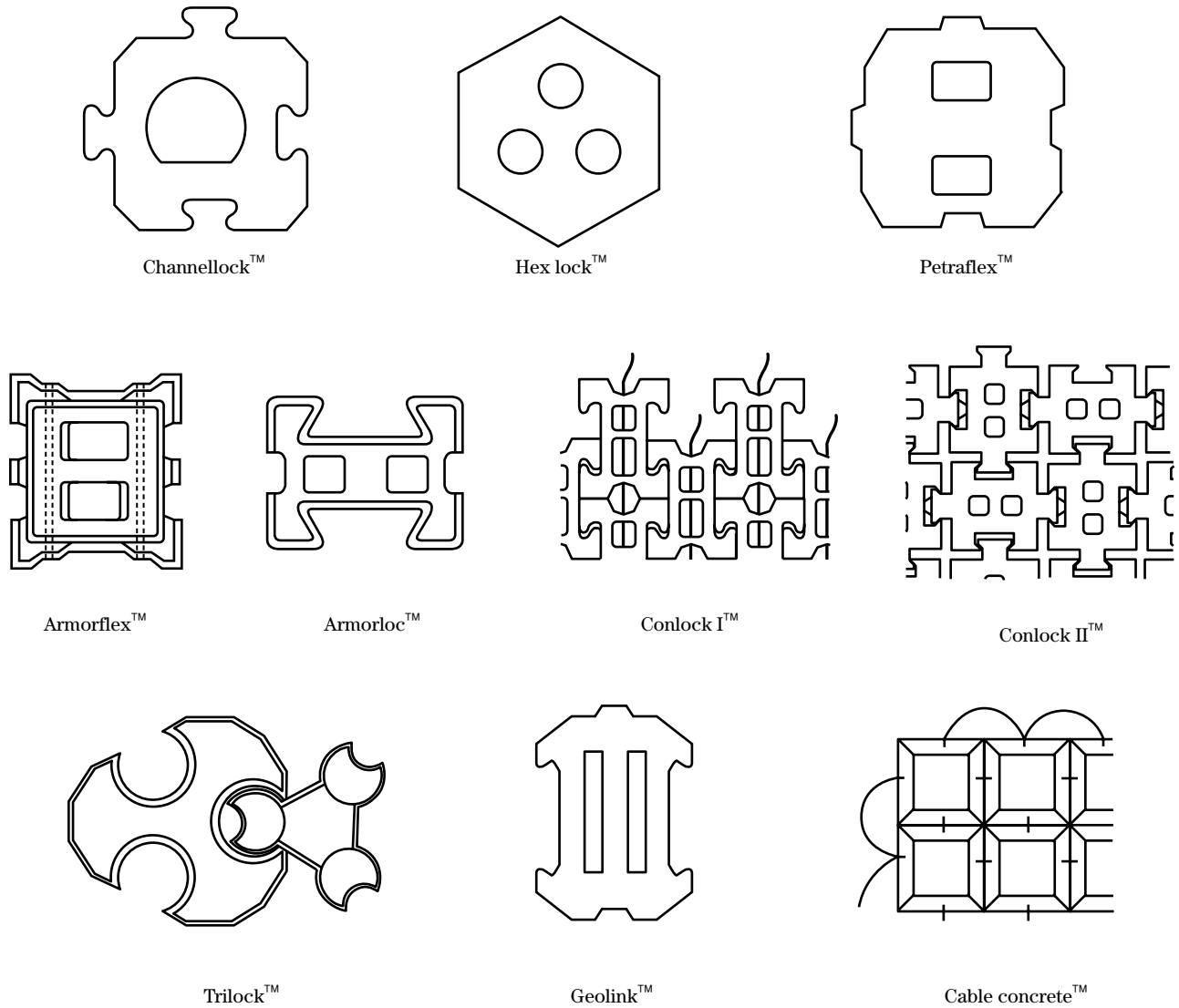

Figure TS14L-8 Steel cables



Figure TS14L-9 Polyester cables



Table TS14L-1 Steel cable specifications

Diameter	Construction	Breaking strength
1/8 in	1 by 19	2,100 lb
5/32 in	1 by 19	3,300 lb
3/16 in	1 by 19	4,700 lb

Table TS14L-2 Polyester cable specifications

Cable diameter (in)	Average strength (lb)	Weight, lb/100 ft	
		Minimum	Maximum
1/4	3,700	2.47	2.74
5/16	7,000	3.99	4.42
3/8	10,000	4.75	5.26
1/2	15,000	8.93	9.90

Figure TS14L-10 ACB section with a geotextile filter and combination geotextile and granular filter (*Figure courtesy of HCFCD*)

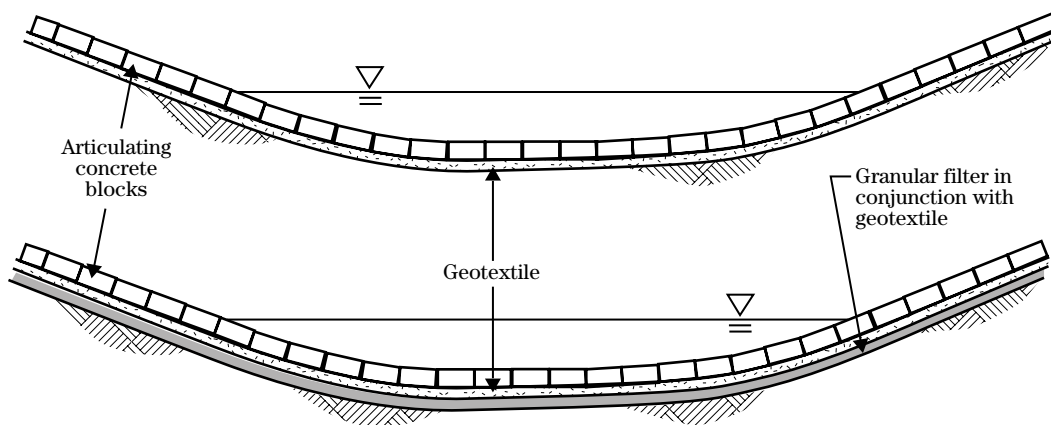

Figure TS14L-11 ACBs in combination with granular and geotextile filter



the local loss of intimate contact between the ACB and the subgrade. The FHWA study (Clopper 1989) identified the following four conditions which may lead to this definition of failure:

- loss of soil beneath the system by gradual erosion beneath the system or washout through the system at joints and open cells
- deformation of the subgrade due to liquefaction and shallow slip failures caused by the ingress of water beneath the system (especially in silty soils on steep slopes)
- loss of block or a group of blocks (uncabled systems) which directly exposes the subgrade to the flow
- flow beneath the ACB causing uplift pressures and separation of the block from the subgrade

Performance testing and evaluation

Due to the proprietary nature and unique characteristics of the ACB revetment systems available, a hydraulic stability test should be completed on each family of blocks. The hydraulic stability test should be conducted in accordance with U.S. Department of Transportation Federal Highway Administration (FHWA) RD-89-199 (Clopper 1989). Research conducted throughout the 1980s (Clopper and Chen 1988; Clopper 1989) led to a definition of failure for ACB revetment systems as

Although loss of intimate contact may not lead to total failure of the system, the stability and continued performance of the system has been compromised.

Each ACB revetment system obtains its stability from a unique set of weight, interblock restraint, geometry, and block-to-block articulation. Therefore, laboratory testing of each family of ACB revetment systems is required to determine the critical shear stress. A schematic of a typical laboratory test flume is shown in figure TS14L-12.

Figure TS14L-12 Schematic of a typical laboratory test flume for ACB performance testing (Figure courtesy of HCFCD)

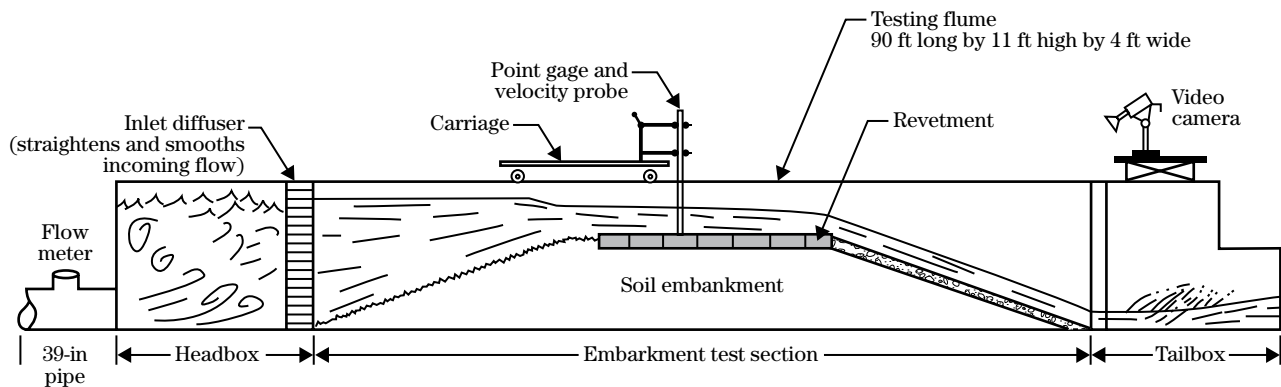

The forces causing overturning and restraining moments are illustrated in figure TS14L-13.

Equation TS14L-1 (HCFCD 2001) shows the restraining moments on the left and overturning moments on the right side of the equation:

$$\ell_2 W_{S2} = \ell_1 W_{S1} + \ell_3 (F_D + F'_D) + \ell_4 (F_L + F'_L) \tag{eq. TS14L-1}$$

The drag force, F'_D , due to protruding blocks (fig. TS14L-14) is a function of the flow velocity and may be expressed by the following equation:

$$F'_D = \frac{1}{2} \times C_D (\Delta Z) b \rho V^2 \tag{eq. TS14L-2}$$

where:

- F'_D = drag force due to block protrusion (lb)
- C_D = drag coefficient ($C_D \approx 1.0$)
- ΔZ = height of protrusion (ft)
- b = block width perpendicular to flow (ft)
- ρ = density of water (1.94 slugs/ft³)
- V = velocity (ft/s)

The added lift force (F'_L) due to the block protruding above the ACB matrix is assumed equal to the drag force.

The ACB design procedure is based on the critical shear stress for a horizontal surface. Performance testing is typically conducted on bed slopes of 2H:1V or 3H:1V. The following equation (HCFCD 2001) may be used to extrapolate the test results to a horizontal surface:

$$\tau_{c\theta U} = \tau_{c\theta T} \times \left(\frac{\ell_2 \cos \theta_U - \ell_1 \sin \theta_U}{\ell_2 \cos \theta_T - \ell_1 \sin \theta_T} \right) \tag{eq. TS14L-3}$$

where:

- $\tau_{c\theta U}$ = critical shear stress for untested bed slope (lb/ft²)
- $\tau_{c\theta T}$ = critical shear stress for tested bed slope (lb/ft²)
- θ_U = untested bed slope (degrees)
- θ_T = tested bed slope (degrees)
- ℓ_x = moment arms (ft)

Performance testing is also typically conducted on one block within the same family. An equation has been developed for extrapolating test results from a tested block to an untested block of similar characteristics. The equation should only be used to extrapolate results for a thicker block within the same family as the tested block. This equation is also based on a moment balance approach that neglects interblock restraint. Equation TS14L-4 (Clopper 1991) is suggested for extrapolation of test results from one block to a thicker block within the same family:

$$\tau_{CU} = \tau_{CT} \times \left(\frac{W_{SU} \ell_{2U}}{W_{ST} \ell_{2T}} \times \frac{\ell_{3T} + \ell_{4T}}{\ell_{3U} + \ell_{4U}} \right) \tag{eq. TS14L-4}$$

Figure TS14L-13 Forces on an ACB revetment system during performance test (Figure courtesy of HCFCD)

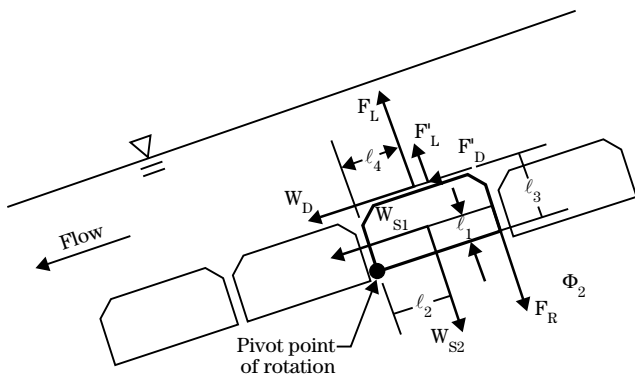
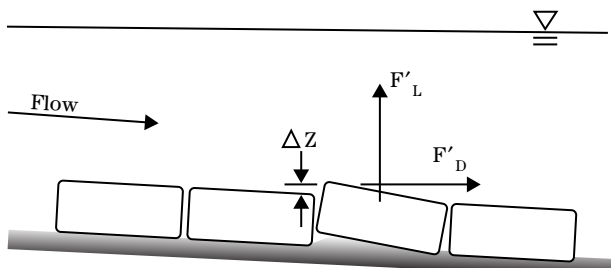

Figure TS14L-14 Forces on a protruding block (Figure courtesy of HCFCD)



where:

τ_{CU} = critical shear stress for untested block (lb/ft²)

τ_{CT} = critical shear stress for tested block (lb/ft²)

W_{SU} = submerged weight of untested blocks (lb)

W_{ST} = submerged tested blocks (lb)

ℓ_{xU} = moment arms of untested blocks

ℓ_{xT} = moment arms of tested blocks (ft)

The moment arms used in these two equations should apply to the orientation of the block during testing and are not necessarily the same as those suggested later in the document for design.

Design procedure

The design of ACB revetment systems must be based on hydraulic analyses of the open channel during the design event. The hydraulic analyses should provide the shear stress and velocity associated with the design event. An example calculation is provided at the end of this technical supplement. The cross-sectional average shear stress may be used for most open channel flow applications. For applications such as bends, confluences, flow constrictions, or flow obstructions, a more detailed, area-specific hydraulic analysis should be considered. Site aesthetics and impacts to habitat should also be considered.

Factor of safety

The design engineer must determine the factor of safety to be used for a particular project. The determination should consider the risks associated with the failure of the ACB revetment system, complexity of the hydraulic system, the uncertainties in hydrologic and hydraulic analyses, and uncertainties associated with ACB revetment system installation. Typically, a minimum factor of safety of 1.5 is used for stream revetment project design. A higher factor of safety of 2.0 should be considered for protection around bridge piers, abutments, at channel bends, or other complex hydraulic systems. A systematic procedure to select a project-specific factor of safety is presented in HCFCD (2001).

Blocks

Failure (loss of intimate contact) is typically the result of the overturning of a block or group of blocks about the downstream contact point of the block. The hydraulic stability of a block on a channel side slope is a function of the magnitude and direction of stream velocity and shear stress, the depth of flow, channel side slope, channel bed slope, interblock restraint, block geometric properties, and the weight of the block. The definition of the forces, dimensions, and angles used in the equation for the factor of safety are depicted in figures TS14L-15 and TS14L-16. The factor of safety equations are defined in table TS14L-3 (HCFCD 2001).

Filter

An appropriate filter design is critical to the successful performance of the ACB revetment system. Design of both a geotextile filter and a granular filter includes determining criteria for filtering and permeability.

References available for design of a geotextile filter include HCFCD (2001); U.S. Department of Agriculture Soil Conservation Service (SCS) (1991); AASHTO (2000), and USACE (1995b). Each of the references includes an analysis of the appropriate geotextile Apparent Opening Size and its permeability. The maximum Apparent Opening Size will allow suitable retention of soil particles, while the minimum geotextile permeability will allow the free flow of water without a buildup of excessive hydrostatic pressure.

Granular filter design criteria are presented in the Natural Resources Conservation Service (NRCS) National Engineering Handbook (NEH), part 633, chapter 26, Gradation design of sand and gravel filters (USDA NRCS 1994). This document provides filter criteria based on the percent finer than the number 200 sieve of the subgrade soil. It also recommends a minimum permeability for any subgrade soil.

Figure TS14L-15 Block on a side slope with design variables (*Figure courtesy of HCFCD*)

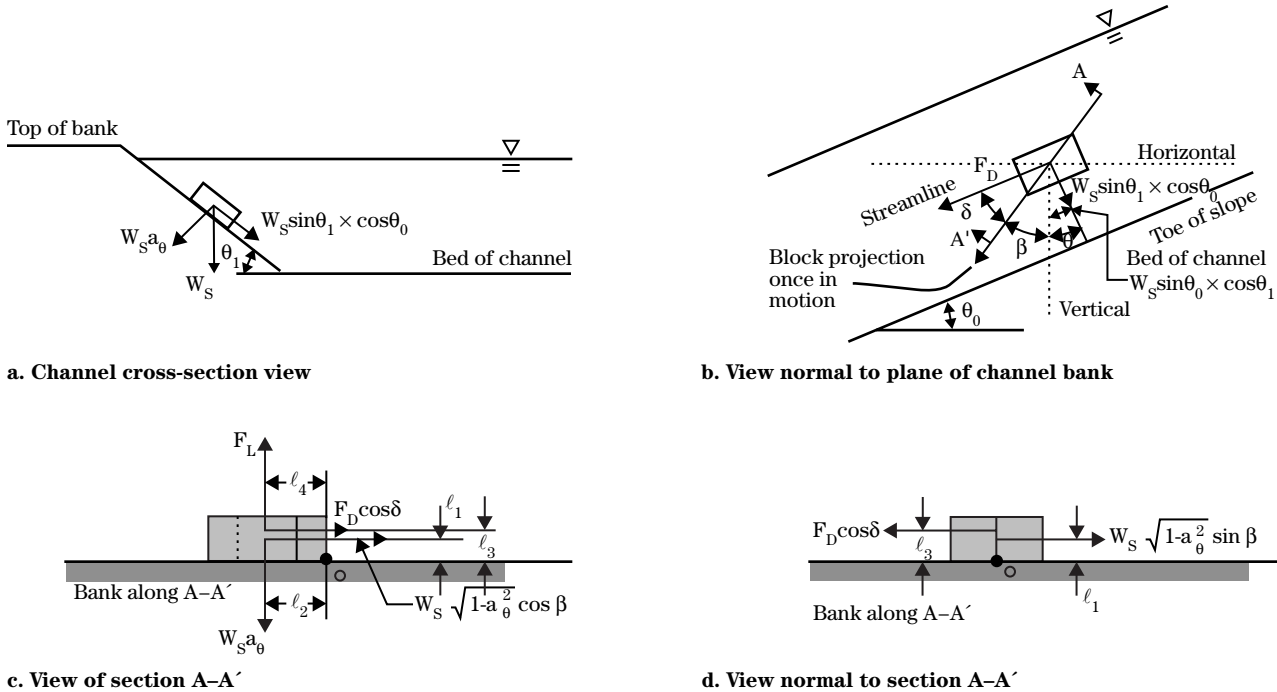

Figure TS14L-16 Block moment arms (*Figure courtesy of HCFCD*)

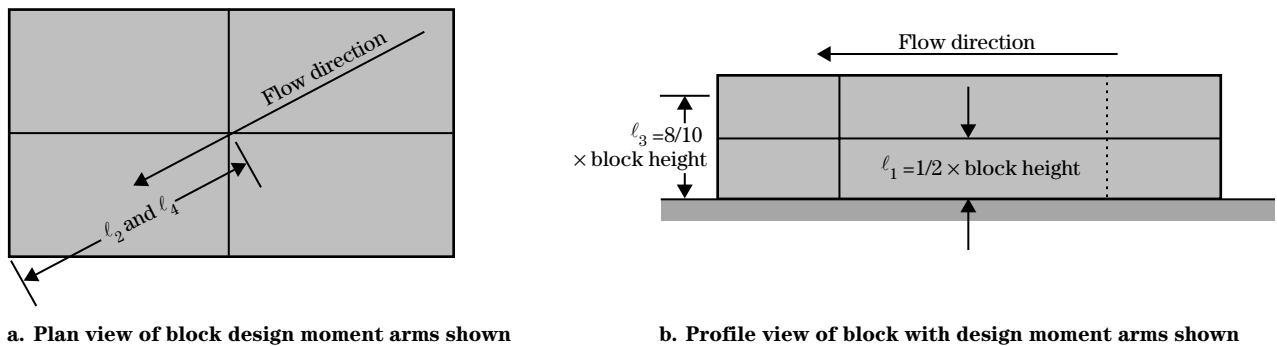

Table TS14L-3 Design equations for ACB revetment systems

$$FS = \frac{\left(\frac{\ell_2}{\ell_1}\right) a_\theta}{\sqrt{1 - a_\theta^2} \cos \beta + \eta_1 \left(\frac{\ell_2}{\ell_1}\right) + \frac{(\ell_3 F'_D \cos \delta + \ell_4 F'_L)}{\ell_1 W_S}}$$

$$\delta + \beta + \theta = 90^\circ \text{ or } \frac{\pi}{2} \text{ radians}$$

$$\eta_1 = \left(\frac{\frac{\ell_4 + \sin(\theta_0 + \theta + \beta)}{\ell_3}}{\frac{\ell_4 + 1}{\ell_3}} \right) \eta_0$$

$$\beta = \arctan \left(\frac{\cos(\theta_0 + \theta)}{\left(\frac{\ell_4 + 1}{\ell_3}\right) \frac{\sqrt{1 - a_\theta^2}}{\eta_0 \left(\frac{\ell_2}{\ell_1}\right)} + \sin(\theta_0 + \theta)} \right)$$

$$\theta = \arctan \left(\frac{\sin \theta_0}{\sin \theta_1} \times \frac{\cos \theta_1}{\cos \theta_0} \right) = \arctan \left(\frac{\tan \theta_0}{\tan \theta_1} \right)$$

$$a_\theta = \sqrt{\cos^2 \theta_1 - \sin^2 \theta_0}$$

$$\eta_0 = \frac{\tau_{des}}{\tau_c}$$

$$F'_L = F'_D = 0.5 \times (\Delta Z) b \rho V_{des}^2$$

$$W_S = W \times \left(\frac{G_c - 1}{G_c} \right)$$

- a_θ = projection of W_s into subgrade beneath block
- b = block width (ft)
- F'_D = additional drag
- F'_L = additional lift force (lb)
- P_x = block moment arms (ft)
- G_c = specific gravity of concrete (assume 2.1)
- FS = calculated factor of safety
- V_{des} = design velocity (ft/s)
- W = weight of block (lb)
- W_s = submerged weight of blocks (lb)
- ΔZ = height of block protrusion above ACB matrix (ft)
- δ = angle of block projection from downward direction, once in motion
- η_0 = angle between drag force and block motion
- η_1 = stability number for a sloped surface
- θ = angle between side slope projection of W_s and the vertical
- θ_0 = channel bed slope (degrees or radians)
- θ_1 = channel side slope (degrees or radians)

Note: the equations cannot be solved for:

- $\theta_1 \cong$ (division by 0); therefore, a negligible side slope must be entered for the case of $\theta_1 \cong 0$
- ρ = mass density of water (1.94 slugs/ft³)
- τ_c = critical shear stress for block on a horizontal surface (lb/ft²)
- τ_{des} = design shear stress (lb/ft²)

Specifying ACB revetment systems

Blocks

The blocks should meet the physical requirements of ASTM D6684, Standard Specification for Materials and Manufacture of Articulating Concrete Block Revetment Systems. Table TS14L-4 presents the physical requirements in specified in ASTM D6684.

In areas subject to freeze-thaw, the number of freeze/thaw cycles and the corresponding weight loss criterion should be specified. Some specifications require 100 freeze-thaw cycles, with no more than 1 percent weight loss as determined on five block samples. The minimum percent open area should also be specified.

Connections

If a cabled system is desired, the cable specifications recommended in this paper should be considered. If the blocks will be adhered to a geotextile, the geotextile should meet the geotextile specifications described in the following section.

Geotextile

The NRCS has developed national construction and material specifications for geotextiles. These are included in NEH, part 642, Specifications for Construction Contracts. Additional material is covered in NEH654 TS14D. The NRCS specifications are broken into woven and nonwoven geotextiles and into various classes. Class I geotextiles are typically specified for erosion protection systems. The class I material properties included in the NRCS material specifications are shown in tables TS14L-5 and TS14L-6.

Testing

A hydraulic stability test conducted in accordance with FHWA RD-89-199 on the proposed ACB revetment system family should be specified. The streambed slope of the project should be no steeper than the slope used in the hydraulic stability test. If the ACB

revetment system is tested with system restraints (such as mechanical anchors) or ancillary components (such as a synthetic or granular drainage medium), these features should also be incorporated into the field installations.

Design

The project-specific design criteria should be specified to allow each ACB revetment system manufacturer to calculate which product should be supplied. The following project conditions should be specified:

- design velocity (ft/s)
- design shear stress (lb/ft²)
- bed slope (ft/ft)
- side slope (H:V) (ft/ft)
- maximum allowable block-to-block placement tolerance (in)
- minimum required factor of safety

Installation

Detailed specifications are required for the installation of ACB revetment systems. Detailed construction specifications for earthwork (including subgrade preparation) and placement of the geotextile are available from the NRCS, USACE, HCFCD, and other organizations. Specifications for ACB installation are available from the USACE, HCFCD, ACB manufacturers, and other organizations, as well. An ASTM Standard Practice for the installation of ACB revetment systems is under development. General installation considerations are listed.

Subgrade preparation

The ACB revetment system should be placed on undisturbed *in situ* soils or properly compacted fill. The subgrade for ACB placement should be graded smooth to ensure that intimate contact is achieved between the soil surface and the geotextile.

Table TS14L-4 Block physical requirements

Minimum compressive strength lb/in ²		Maximum water absorption lb/ft ³		Minimum density lb/ft ³	
3 unit avg.	Individual unit	3 unit avg.	Individual unit	3 unit avg.	Individual unit
4,000	3,500	9.1	11.7	130	125

Table TS14L-5 NRCS specifications for woven geotextiles

Property	Test method	Class I
Tensile strength (lb) ^{1/}	ASTM D4632	200 minimum in any principal direction
Elongation at failure (%) ^{1/}	ASTM D4632	<50
Puncture (lb) ^{1/}	ASTM D4833	90 minimum
UV (% residual tensile strength)	ASTM D4355 150-hr exposure	70 minimum
Apparent opening size ^{2/}	ASTM D4751	As specified, but no smaller than 0.212 mm (#70) ^{3/}
Percent open area (%)	CWO-02215	4.0 minimum
Permittivity s ⁻¹	ASTM D4491	0.10 minimum

1/ Minimum average roll value (weakest principal direction)

2/ Maximum average roll value

3/ U.S. standard sieve size

Note: CWO is a USACE reference

Table TS14L-6 NRCS specifications for nonwoven geotextiles

Property	Test method	Class I
Tensile strength (lb) ^{1/}	ASTM D4632	180
Elongation at failure (%) ^{1/}	ASTM D4632	>50
Puncture (lb) ^{1/}	ASTM D4833	80 minimum
UV (% residual tensile strength)	ASTM D4355 150-hr exposure	70 minimum
Apparent opening size ^{2/}	ASTM D4751	As specified, max. #40 ^{3/}
Permittivity s ⁻¹	ASTM D4491	0.70 minimum

1/ Minimum average roll value (weakest principal direction)

2/ Maximum average roll value

3/ U.S. standard sieve size

Geotextile placement

The geotextile should be laid flat and smooth, so that it is in intimate contact with the subgrade. The geotextile must be free of tension, folds, and wrinkles. The geotextile should be placed immediately prior to ACB placement.

The joints should overlap a minimum of 18 inches in dry installations and 3 feet in below water installations. The geotextile joints should be shingled so that the upstream or upslope geotextile overlaps the adjacent downstream or downslope geotextile.

When a granular filter is used in combination with a geotextile filter, or the geotextile is placed on a silty sand or fine to medium sand subgrade, the geotextile should encapsulate the granular filter for a minimum length of 1 foot of the subgrade (fig. TS14L-17).

Placement of the ACB

The cellular concrete blocks should be placed on the geotextile or subgrade in such a manner as to produce a smooth planar surface in intimate contact with the geotextile or subgrade. No individual block within the plane of placed cellular concrete blocks should protrude more than the maximum amount of protrusion used in the design and specified for the project. If assembled and placed as large mattresses, the cellular concrete mats are placed by a crane or other approved equipment and attached to a spreader bar or other approved device (fig. TS14L-18), to aid in the lifting and placing of the mats in their proper position.

The equipment used should have adequate capacity to place the mats without bumping, dragging, tearing or otherwise damaging the underlying fabric. The mats are placed side by side or end to end, so that the mats abut each other. Mat seams, or openings between mats, that are greater than the typical separation distance between blocks should be filled with grout. Whether placed by hand (fig. TS14L-19) or in large mattresses, distinct changes in grade that result in a discontinuous revetment surface in the direction of flow should include a grout seam at the grade change location so as to produce a continuous surface.

Termination

The ends of the ACB revetment system should be buried in termination trenches. Termination (or top of slope) trenches, as shown in figure TS14L-20, and side trenches are backfilled and compacted flush with the top of the blocks. The trench may also be backfilled with properly sized riprap, concrete, or other armoring material. The transition from the slope into the trench should be rounded. The integrity of a soil trench backfill must be maintained to ensure a surface that is flush with the top surface of the cellular concrete blocks for its entire service life. Toe trenches are backfilled as shown on the contract drawings. Backfilling and compaction of trenches are completed in a timely fashion. No more than 500 lineal feet of placed cellular concrete blocks, without completed termination or toe trenches, is permitted at any time.

Anchor penetrations

Anchor penetrations through the geotextile should be filled with grout to reduce migration of the subgrade soil through the penetration point.

Filling

The open area of the ACB is filled with topsoil to support vegetative growth (fig. TS14L-21), or gravel material can be used as fill. The fill within the open area should be completed as soon as possible. Topsoil should be overfilled by 1 to 2 inches to allow consolidation of the fill material. A vegetated condition will improve the overall stability of the system by root penetration and anchorage; however, the additional stability benefit provided by vegetation is ignored for the sake of conservatism in the design procedure. Preferred vegetation through the blocks is native grasses. Woody shrubs and trees are discouraged due to the potential for root heaving on blocks. Figures TS14L-22 and TS14L-23 show the same project as in figure TS14L-21 after establishment of vegetation.

Figure TS14L-17 Granular filter encapsulation by a geotextile (*Figure courtesy of HCFC*)

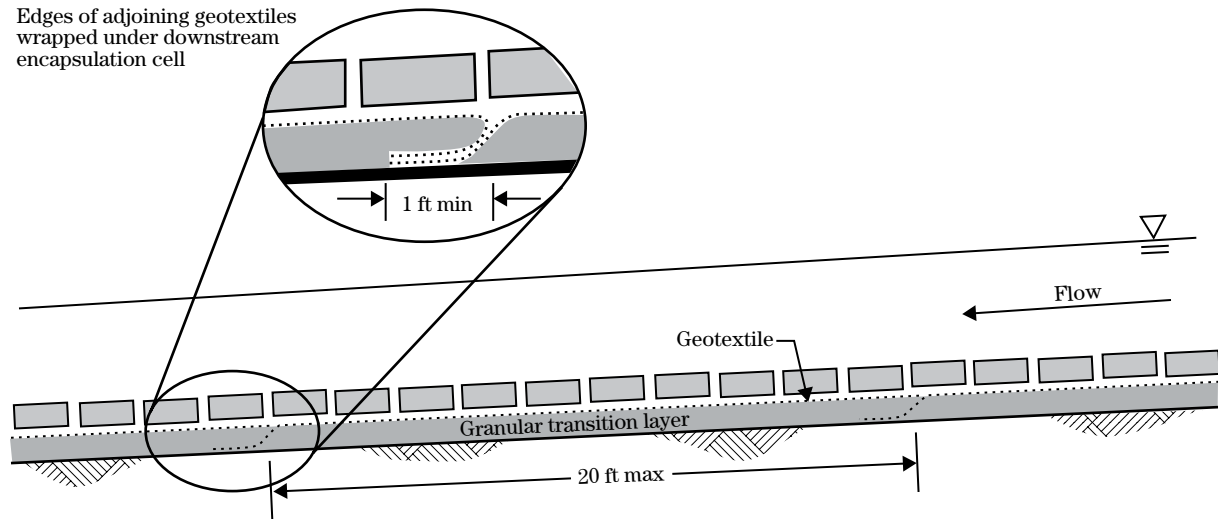

Figure TS14L-18 Spreader bar for placement of cabled mats



Figure TS14L-19 Hand placement of ACB blocks



Figure TS14L-20 ACB termination trench



Figure TS14L-21 Filling ACBs with top soil (*Photo courtesy of Joe Polulech*)



Figure TS14L-22 ACB revetment system 1 year after completion (*Photo courtesy of Joe Polulech*)



Figure TS14L-23 ACB revetment system 2 years after completion (*Photo courtesy of Joe Polulech*)



ACB example calculations

Given: An ACB revetment system is to be installed on the side slopes of a stream channel in the vicinity of a highway bridge. A hydraulic analysis has been conducted, and the following conditions are recommended for the design:

Design velocity:	11 ft/s
Design shear stress:	2 lb/ft ²
Bed slope:	0.03 ft/ft
Side slope:	2H:1V
Allowable block protrusion	1 in
Minimum factor of safety	1.5

The proposed ACB product has the following characteristics:

Weight, W	35 lb
Block width, b	1.1 ft
Block length, l	0.97 ft
Block thickness	4.75 in
Critical shear stress of block on a horizontal surface	15 lb/ft ²
Specific gravity of concrete	2.2

Determine: The factor of safety for the proposed product

Solution:

Step 1 Calculate the moment arms of the proposed block.

$$\ell_1 = \frac{1}{2} \times \text{block thickness} = \frac{1}{2} \times \frac{4.75}{12} = 0.198 \quad (\text{eq. TS14L-5})$$

$$\begin{aligned} \ell_2 &= \ell_4 \\ &= \sqrt{(\text{block length})^2 + (\text{block width})^2} \\ &= \sqrt{(0.97)^2 + (1.1)^2} \\ &= 0.733 \end{aligned} \quad (\text{eq. TS14L-6})$$

$$\begin{aligned} \ell_3 &= 0.8 \times \text{block thickness} \\ &= 0.8 \times \frac{4.75}{12} \\ &= 0.317 \end{aligned} \quad (\text{eq. TS14L-7})$$

Step 2 Calculate the submerged unit weight of block.

$$\begin{aligned} W_S &= W \times \left(\frac{G_c - 1}{G_c} \right) \\ &= 35 \times \left(\frac{2.2 - 1}{2.2} \right) \quad (\text{eq. TS14L-8}) \\ &= 19.1 \text{ lb} \end{aligned}$$

Step 3 Calculate the stability number on a horizontal surface.

$$\begin{aligned} \eta_0 &= \frac{\tau_{\text{des}}}{\tau_c} \\ &= \frac{2}{15} \quad (\text{eq. TS14L-9}) \\ &= 0.133 \end{aligned}$$

Step 4 Calculate additional lift and drag forces from block protrusion.

$$\begin{aligned} F'_L &= F'_D \\ &= 0.5 \times (\Delta Z) b \rho V_{\text{des}}^2 \\ &= 0.5 \times \left(\frac{0.5}{12} \right) \times 1.1 \times 1.94 \times 11^2 \quad (\text{eq. TS14L-10}) \\ &= 5.4 \text{ lb} \end{aligned}$$

Step 5 Calculate a_θ .

$$a_\theta = \sqrt{\cos^2 \theta_1 - \sin^2 \theta_0} \quad (\text{eq. TS14L-11})$$

$$\begin{aligned} \theta_0 &= \text{ATAN}(\text{bed slope}) \\ &= \text{ATAN}(0.03) \quad (\text{eq. TS14L-12}) \\ &= 1.72^\circ \end{aligned}$$

$$\begin{aligned} \theta_1 &= \text{ATAN} \left(\frac{1}{\text{channel slope}} \right) \\ &= \text{ATAN} \left(\frac{1}{2} \right) \\ &= 26.57^\circ \end{aligned}$$

$$\begin{aligned} \alpha_\theta &= \sqrt{\cos^2 (26.57) - \sin^2 (1.72)} \\ &= 0.894 \end{aligned}$$

Step 6 Calculate θ .

$$\begin{aligned} \theta &= \arctan\left(\frac{\sin\theta_0}{\sin\theta_1} \times \frac{\cos\theta_1}{\cos\theta_0}\right) \\ &= \arctan\left(\frac{\tan\theta_0}{\tan\theta_1}\right) \\ &= \arctan\left(\frac{\tan 1.72^\circ}{\tan 26.57^\circ}\right) \\ &= 3.43^\circ \end{aligned} \quad (\text{eq. TS14L-13})$$

Step 7 Calculate β .

$$\beta = \arctan\left(\frac{\cos(\theta_0 + \theta)}{\left(\frac{\ell_4}{\ell_3} + 1\right) \frac{\sqrt{1 - a_\theta^2}}{\eta_0 \left(\frac{\ell_2}{\ell_1}\right)} + \sin(\theta_0 + \theta)}\right) \quad (\text{eq. TS14L-14})$$

$$\begin{aligned} \beta &= \arctan\left(\frac{\cos(1.72^\circ + 3.43^\circ)}{\left(\frac{0.733}{0.317} + 1\right) \frac{\sqrt{1 - 0.894^2}}{0.133 \left(\frac{0.733}{0.198}\right)} + \sin(1.72^\circ + 3.43^\circ)}\right) \\ &= 17.82^\circ \end{aligned} \quad (\text{eq. TS14L-15})$$

Step 8 Calculate stability number for a sloped surface η_1 .

$$\begin{aligned} \eta_1 &= \left(\frac{\frac{\ell_4}{\ell_3} + \sin(\theta_0 + \theta + \beta)}{\frac{\ell_4}{\ell_3} + 1}\right) \eta_0 \\ &= \left(\frac{\frac{0.733}{0.317} + \sin(1.72^\circ + 3.43^\circ + 17.82^\circ)}{\frac{0.733}{0.317} + 1}\right) 0.133 \\ &= 0.109 \end{aligned} \quad (\text{eq. TS14L-16})$$

Step 9 Calculate angle between drag force and block motion, δ .

$$\delta + \beta + \theta = 90^\circ \quad (\text{eq. TS14L-17})$$

$$\delta = 90^\circ - \beta - \theta$$

$$\begin{aligned} \text{So, } \delta &= 90^\circ - 17.82^\circ - 3.43^\circ \\ &= 68.75^\circ \end{aligned} \quad (\text{eq. TS14L-18})$$

Step 10 Calculate the factor of safety for the proposed block, SF. (See equations for step 10 in box at the bottom of page.)

Solution: FS = 1.63 > 1.5
Factor of safety is acceptable

Step 10 calculations:

$$\begin{aligned} \text{FS} &= \frac{\left(\frac{\ell_2}{\ell_1}\right) a_\theta}{\sqrt{1 - a_\theta^2} \cos\beta + \eta_1 \left(\frac{\ell_2}{\ell_1}\right) + \frac{(\ell_3 F'_D \cos\delta + \ell_4 F'_L)}{\ell_1 w_S}} \quad (\text{eq. TS14L-19}) \\ \text{FS} &= \frac{\left(\frac{0.733}{0.198}\right) 0.894}{\sqrt{1 - 0.894^2} \cos 17.82^\circ + 0.109 \left(\frac{0.733}{0.198}\right) + \frac{(0.317 \times 5.379 \times \cos 68.75^\circ + 0.733 \times 5.379)}{0.198 \times 1.9}} \end{aligned}$$

If the critical shear stress is determined from an ACB hydraulic test with system restraints (such as mechanical anchors) or ancillary components (such as a synthetic or granular drainage medium), the restraints or components should be incorporated into the installation.

Conclusion

ACB revetment systems provide a viable product for armoring countermeasures to be used in stream restoration and stabilization, particularly in open channels that have high velocities and shear stresses and in applications where the operational boundaries are fixed or limited and no further erosion can be tolerated.

An ACB revetment system is also useful in arresting lateral stream migration and local vertical instability. Its use has distinct advantages, not only in terms of accepted design techniques, but also in established contracting and construction procedures.

The blocks must be tested in accordance with the procedures identified in this technical supplement and the associated references. Design should follow the design procedures as shown here. ACBs should be considered as a system and include all the restraints and components in the hydraulic stability testing. The use of a properly designed geotextile or granular filter is critical to the successful performance of the ACB revetment system. As with all armoring countermeasures, proper subgrade preparation, placement of geotextile or granular filter, and block installation are also essential to the proper functioning and performance of the system during the design event.

The decision to use an ACB revetment system for stabilization must include considerations for costs, performance requirements, maintenance, aesthetic characteristics, ecological habitat and functions, upstream and downstream effects, and the dynamics of fluvial geomorphology of the system.

As described, some ACB systems provide the flexibility of including grass in topsoil-filled block openings to provide additional erosion control. Since the use of woody vegetation is discouraged because of its potential damage to the block installation and maintenance costs, the prospect of reestablishing a fully functioning riparian zone is minimal. Where connection of people back to the stream is an important consideration, however, ACBs can provide a foundation for grassed greenways to be established along stabilized channels.

